

GROUNDWATER SAMPLING

SURFACE COLLARED BOREHOLES:

- *PRODUCTION INFLATION PACKERS (PIPs): used to isolate selected borehole intervals for sample collection;*
- *WESTBAY MP CASING SYSTEMS: water samples collected through piezometer and pumping ports;*
- *AECL MP CASING SYSTEMS: water samples collected from open standpipes*

BOREHOLES COLLARED UNDERGROUND:

- *AECL MP CASING SYSTEMS AND CAPPED BOREHOLES: water samples collected from open standpipes or boreholes*



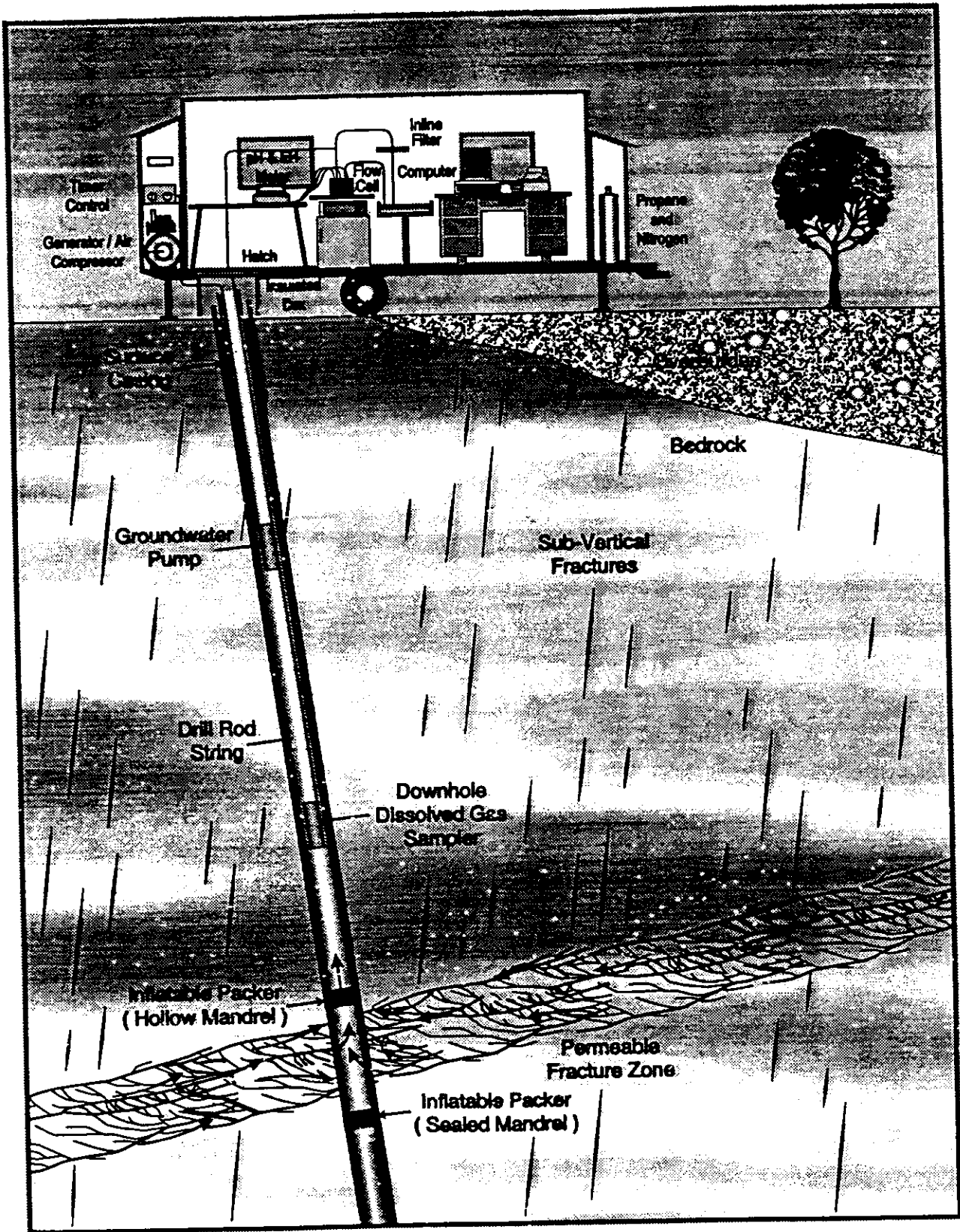

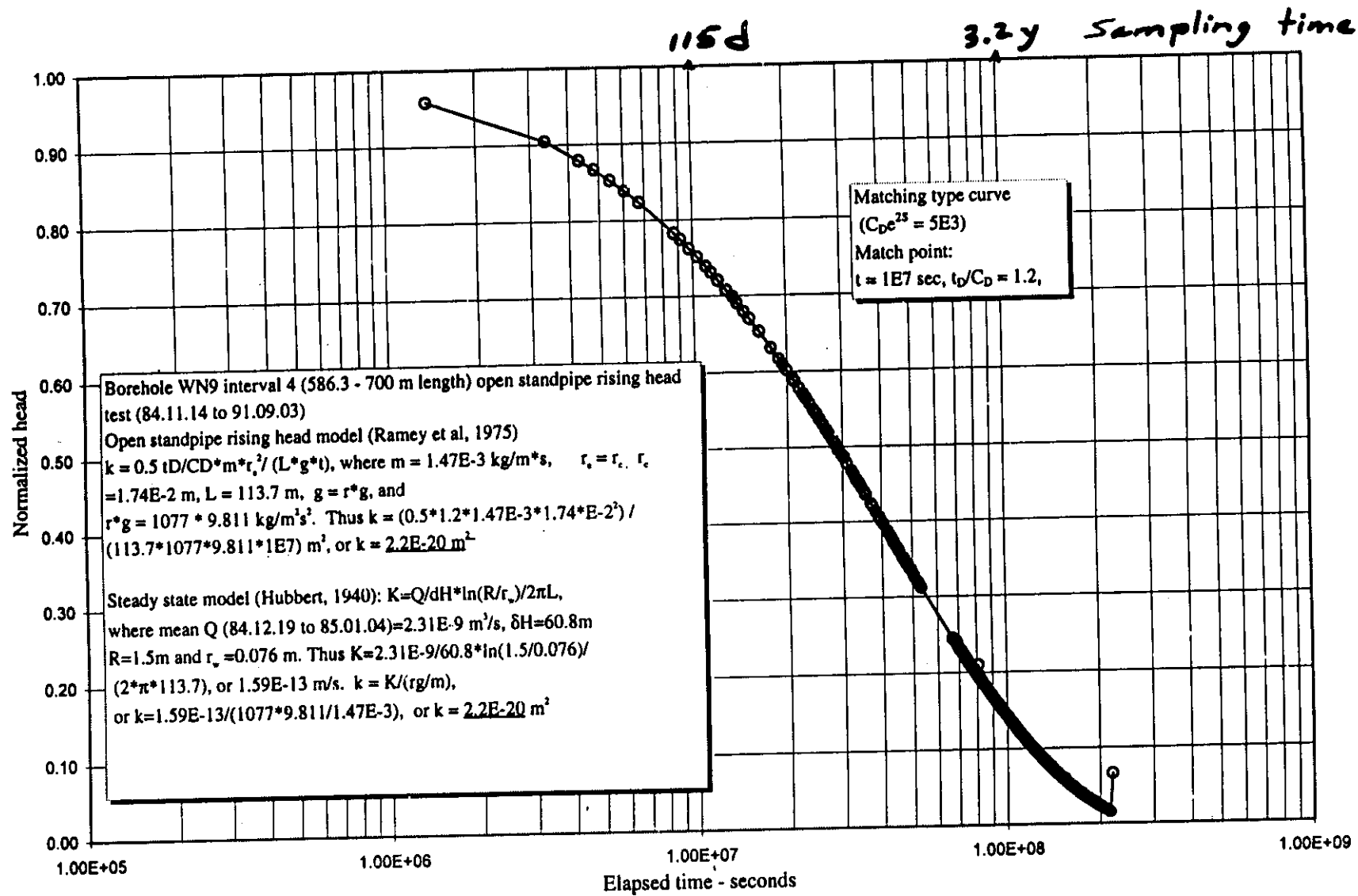

Figure 13: Plot of normalized recovery of WN9 piezometer interval 4 open standpipe water level versus recovery time

TABLE 6-4
GROUNDWATER SAMPLING, SAMPLE PREPARATION AND ANALYSIS METHODS

Sample	Species/Element	Container	Volume	Filtered	Preservative (Preparation)	Analytical Methods ¹	Laboratory
Anions	HCO ₃ , SO ₄ , Cl, Br, F, NO ₃ , I	Plastic	250 mL	Yes	Refrigerate (4°C)	Titration, IC Colorimetry	HGC ²
Cations	Na, Ca, Mg, K, Sr, Si, B	Plastic	125 mL	Yes	4 mL/L HCl	ICPS flame AAS	ASB ³
Trace elements	Li, Fe, Mn, V, Al + others	Plastic	125 mL	Yes	8 mL/L HNO ₃	ICPS colorimetry	ASB
Dissolved organic carbon	Organic C	Glass	125 mL	Yes	Refrigerate (Ag)	Infrared analyzer	P. Vilks, GRB ⁴
Colloids	Colloidal fractions	Plastic	50 L	No	N ₂ purge	Tangential flow	P. Vilks, GRB
Environmental isotopes	² H, ³ H, ¹⁸ O, ³ H (enriched)	Plastic Glass	125 mL 1 L	Yes Yes	None None	MS LSC	ASB, Univ of Waterloo
Carbon isotopes	¹³ C, ¹⁴ C	Plastic	4-100 L	No	None (±PC, BaCO ₃ or in NaOH) ⁵	MS LSC AMS MS	Univ of Waterloo & Toronto
Sulphur isotopes	S ¹⁸ O ₄ , ³⁴ SO ₄	Plastic	1-4 L	Yes	None (PC, ion exchange or BaSO ₄) ⁵	MS MS	Univ of Waterloo
Chlorine isotopes	³⁶ Cl,	Plastic	1-4 L	Yes	None (PC, AgCl) ⁵	AMS	Univ of Rochester
Strontium isotopes	⁸⁷ Sr/ ⁸⁶ Sr	Plastic	250 mL	Yes	8 mL/L HNO ₃	MS	RH McNutt, McMaster Univ
Uranium and radium isotopes	U, ²³⁴ U/ ²³⁸ U, ²²⁶ Ra	Plastic	1-4 L	Yes	8 mL/L HNO ₃	AS	HGC
Radon	²²² Rn	Glass vial	8mL	No	None	LSC	HGC
Dissolved gases	H ₂ , He, O ₂ , N ₂ , CO ₂ , CH ₄ , Ar, H ₂ S	Steel cylinder	50 mL	No	None	MS	ASB
Dissolved inert gases	He, ³ He/ ⁴ He, Ne isotopes	Copper tube	10 mL	No	None	MS	WB Clarke, McMaster Univ

IC = Ion Chromatography
 ICPS = Inductively Coupled Plasma Spectrometry,
 AAS = Atomic Absorption Spectrometry,
 (A)MS = (Accelerator) Mass Spectrometry,
 LSC = Liquid Scintillation Counting,
 AS = Alpha Spectrometry

2 HGC = Hydrogeochemistry Section, AECL, Pinawa
 3 ASB = Analytical Science Branch, AECL, Pinawa
 4 GRB = Geochemistry Research Branch, AECL, Pinawa
 5 PC = Preconcentration (Preparation) done at AECL followed by method used

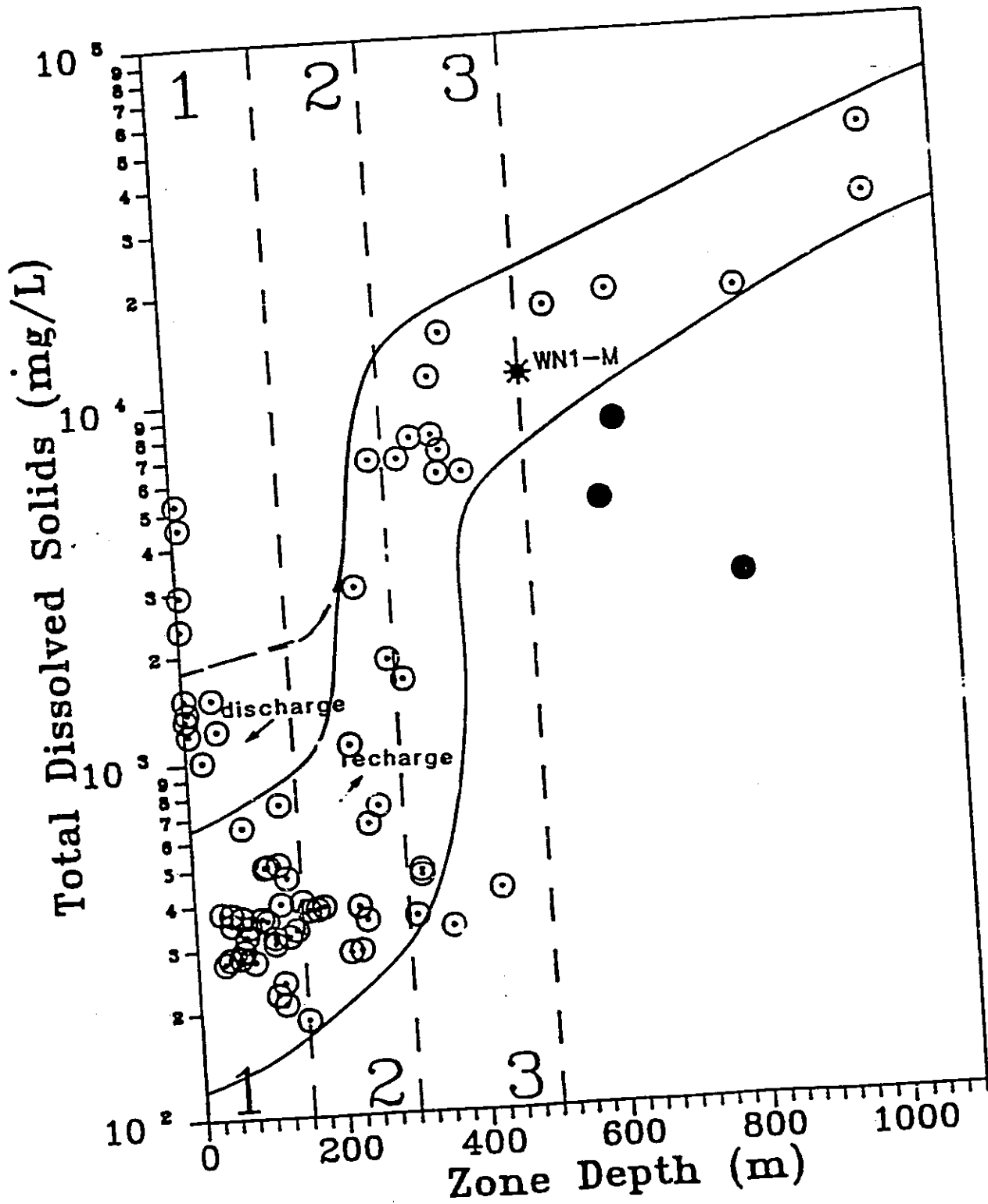

CANDIDATE AREA CHARACTERIZATION :

- *OPTIMIZING SITE CHARACTERIZATION COSTS*
- *REMOTE SENSING, AIRBORNE SURVEYS, AND RECONNAISSANCE MAPPING*
- *BOREHOLE SITING, DRILLING AND LOGGING, AND TESTING*
- *PIEZOMETER CONSTRUCTION AND MONITORING*
- *GROUNDWATER SAMPLING*
- *DATA COLLECTION, ANALYSIS AND ARCHIVING*
- *CONCEPTUAL HYDROGEOLOGIC MODEL CONSTRUCTION*



DATA COLLECTION, ANALYSIS AND ARCHIVING

DATA COLLECTION (QUALITY ASSURANCE FORMAT)

- *HYDRAULIC TESTING: pressure transmitters, flow computer and thermistors to analog/digital board to master control computer; linked computer for data analysis, printer/plotter; data loggers*
 - *for interference test boreholes;*
- *PIEZOMETRIC LEVEL MONITORING: pressure transmitters to data loggers or HDAS / UDAS.*

DATA ANALYSIS:

- *HYDRAULIC TESTING: steady state / transient, constant head / flow tests, pulse tests, slug / rising head tests, interference tests.*
- *FRESH WATER HYDRAULIC HEAD: calculations, plots.*
- *HYDROSTRATIGRAPHIC UNITS: geologic logs; geophysical logs; borehole hydraulic test data; hydraulic head plots.*

DATA ARCHIVING:

- *BACKUP; weekly computer files, reports and hardcopy (maps, files)*



TABLE A2TEST INJECTION INFORMATION SHEETAECL SINGLE HOLE HYDRAULIC TESTING PROGRAM

FIELD NOTES: Test Information DATE: May 25, 1992

AECL SITE: URL - Boggy Creek AECL HYDROGEOLOGIST: Rod Broadfoot

BOREHOLE: URL-15 TEST INTERVAL: 260 - 408 m.

TEST TYPE: Constant Flow DATA FILE NAME: U15002BP

TEST INSTRUCTION FORM REFERENCE NO: _____

TEST PLAN:

1) INJECTION TEST X DRAWDOWN TEST _____

PULSE: _____ psi _____ m. SLUG: _____ psi _____ m

CONSTANT HEAD: _____ psi _____ m

CONSTANT FLOW: 18463 ml/min 3.077 E-4 m³/sec

TEST DURATION: _____ 11100 sec _____ 185 min. _____ 3.0833hrs

2) RECOVERY DURATION

SLUG: _____ sec _____ min _____ hrs

PULSE: _____ sec _____ min _____ hrs

CONSTANT HEAD: _____ sec _____ min _____ hrs

CONSTANT FLOW: _____ 11100 sec _____ 185 min _____ 3.0833hrs

TEST NOTES

1) INJECTION TEST: X DRAWDOWN TEST: _____

MAX. FLOW CHANGE DURING CONSTANT HEAD TEST: _____ ml/min

MAX. HEAD CHANGE DURING CONSTANT FLOW TEST: 2.38 PSI 1.673 Meters

2) EQUIPMENT OPERATION:

PACKERS: 500 psi OVER-PRESSURE

QA VALVE: OK. OPEN TO START

DOWNHOLE D.A. SYSTEM: WESTBAY TRANSDUCER #003

UPHOLE D.A. SYSTEM: COMPAQ 286. ACir A/D BOARD. FLOW COMPUTER FC-81

WATER INJECTION: FLOW TURBINE FT-10

ZONE TEMPERATURE: START TEST: 1.409 V 10.5° C.

END TEST: 1.410 V 10.7° C.

3) GENERAL COMMENTS:

URL-14 UPPER ZONE - NO RESPONSE

URL-14 LOWER ZONE - 37 mm RESPONSE

EQUIPMENT FUNCTIONING NORMAL

TABLE A3INJECTION INFORMATION SHEETAECL SINGLE HOLE HYDRAULIC TESTING PROGRAM

FIELD NOTES: Test Information DATE: May 25, 1992

AECL SITE: URL Boggv Creek AECL HYDROGEOLOGIST: Rod Broadfoot
 BOREHOLE: URL-15 TEST INTERVAL: 260 - 408 m.
 TEST TYPE: Constant Flow DATA FILE NAME: U15002BP
 TANK CALIBRATION: 76.92 ml/mm

1) SYSTEM TEST

a) Leak Test

Pressure (psi)	Tank Level (mm)		Volume Used		Leakage Rate	
	Start	Finish	(mm)	(ml)	(ml/min)	---
30						---
90						---
150					No Leakage	---

b) Time vs. Flowrate & Pressure

(See Table and Graph) N/A2) SYSTEM OPERATION

INJECTION DURATION: 11100 sec 185 min 3.0833 hrs
 WATER QUALITY: Temp. 10°C Conductivity 120 mS/cm²
 TANK LEVEL: Start _____ mm Finish _____ mm Total _____ mm
 VOLUME INJECTED: _____ mm x 76.92 ml/min = _____ ml
 VOLUME CHECK: Q _____ ml/min x _____ min = _____ ml
 ROSEMOUNT D.P. TRANS: Not Used mm Volume _____ ml
 CALCULATED Q: Vol _____ ml/ _____ min = _____ ml/min

Time (sec)	Flowrate (ml/min)		System Pressure (psi)	
	Gross	Net	Tank	Injection
1000		18500		
12100		18346		
		Total Volume -		
		3011.56 L		

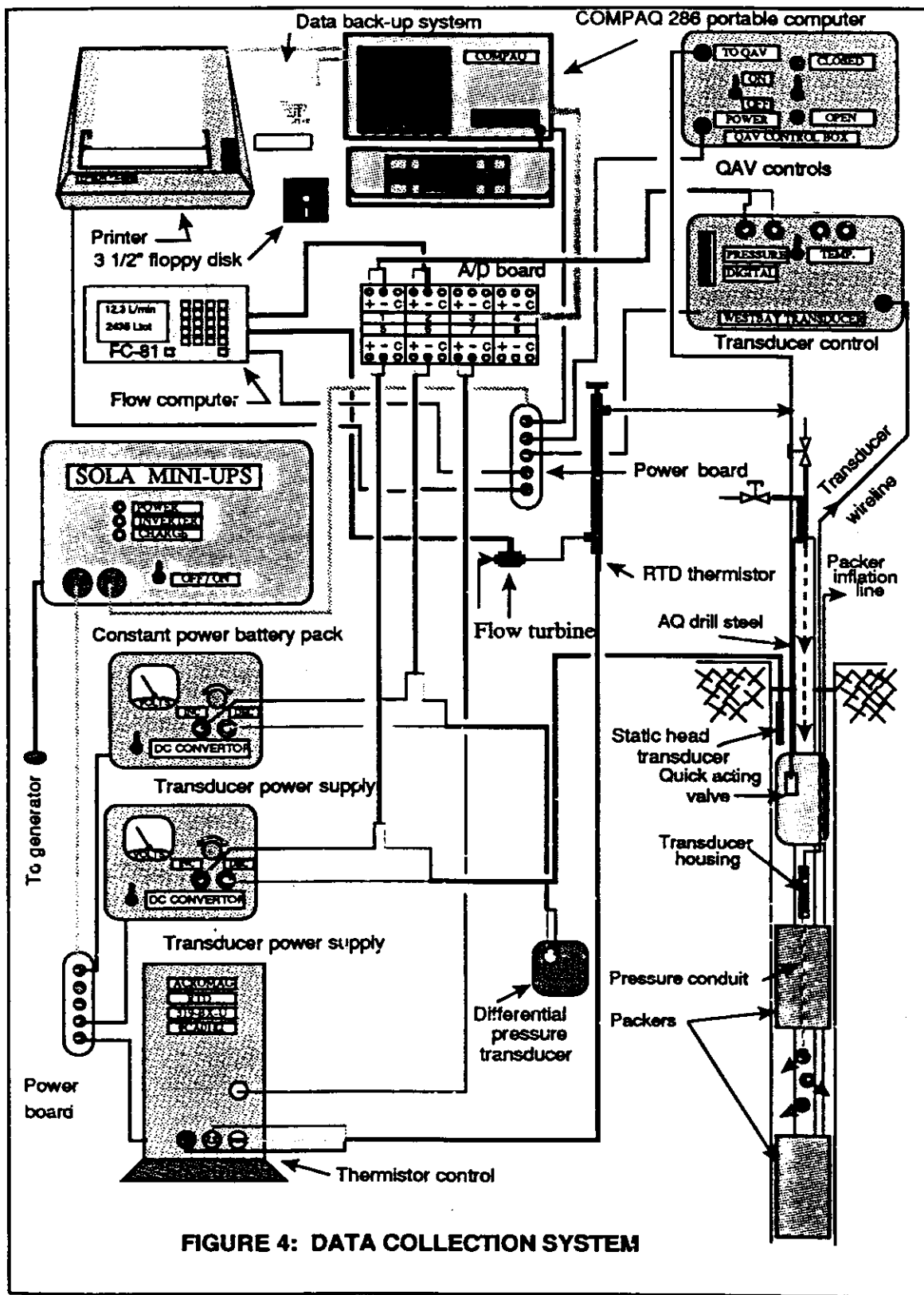

FIGURE 4: DATA COLLECTION SYSTEM

8. DATA COLLECTION FLOW CHART

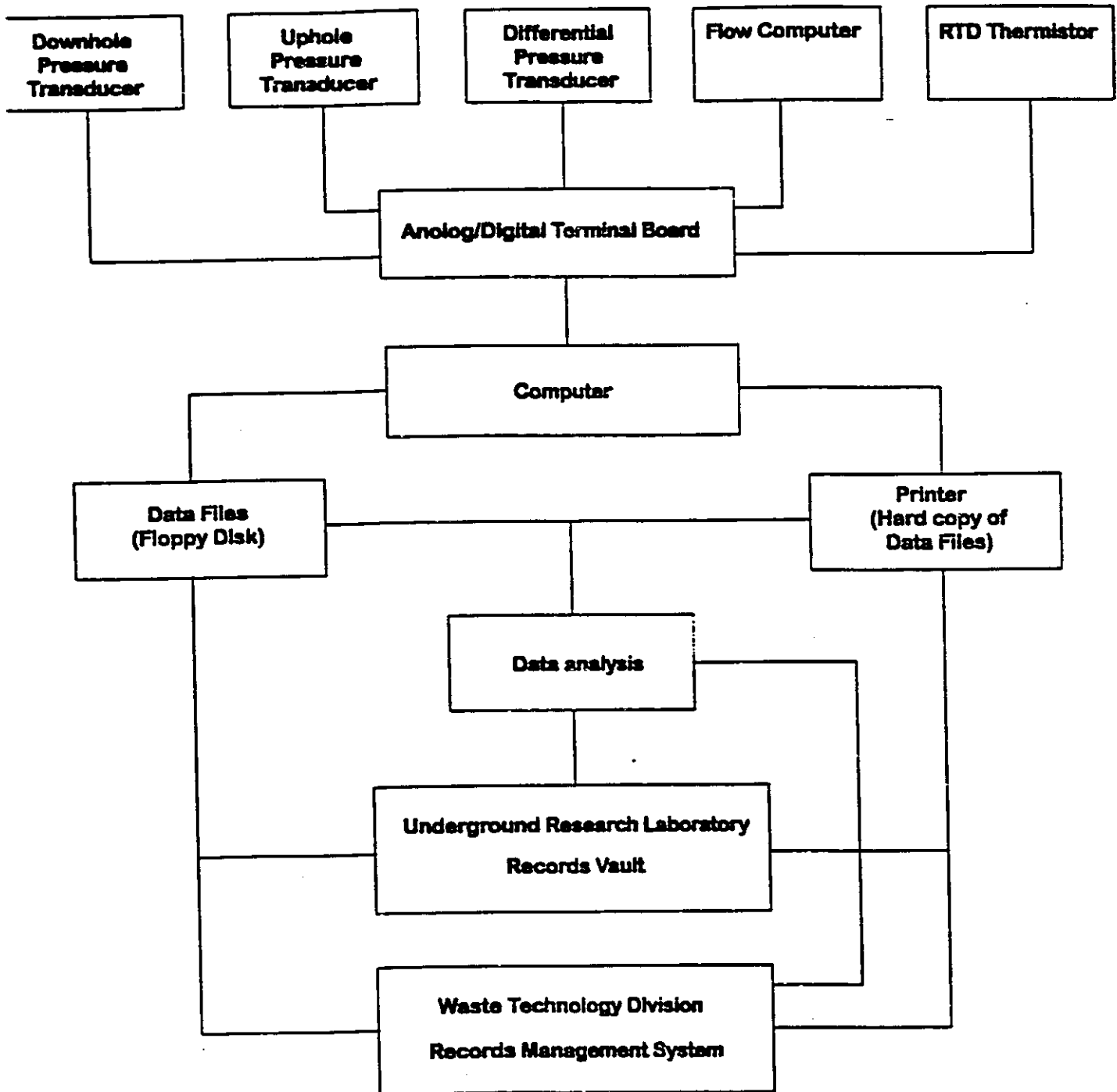
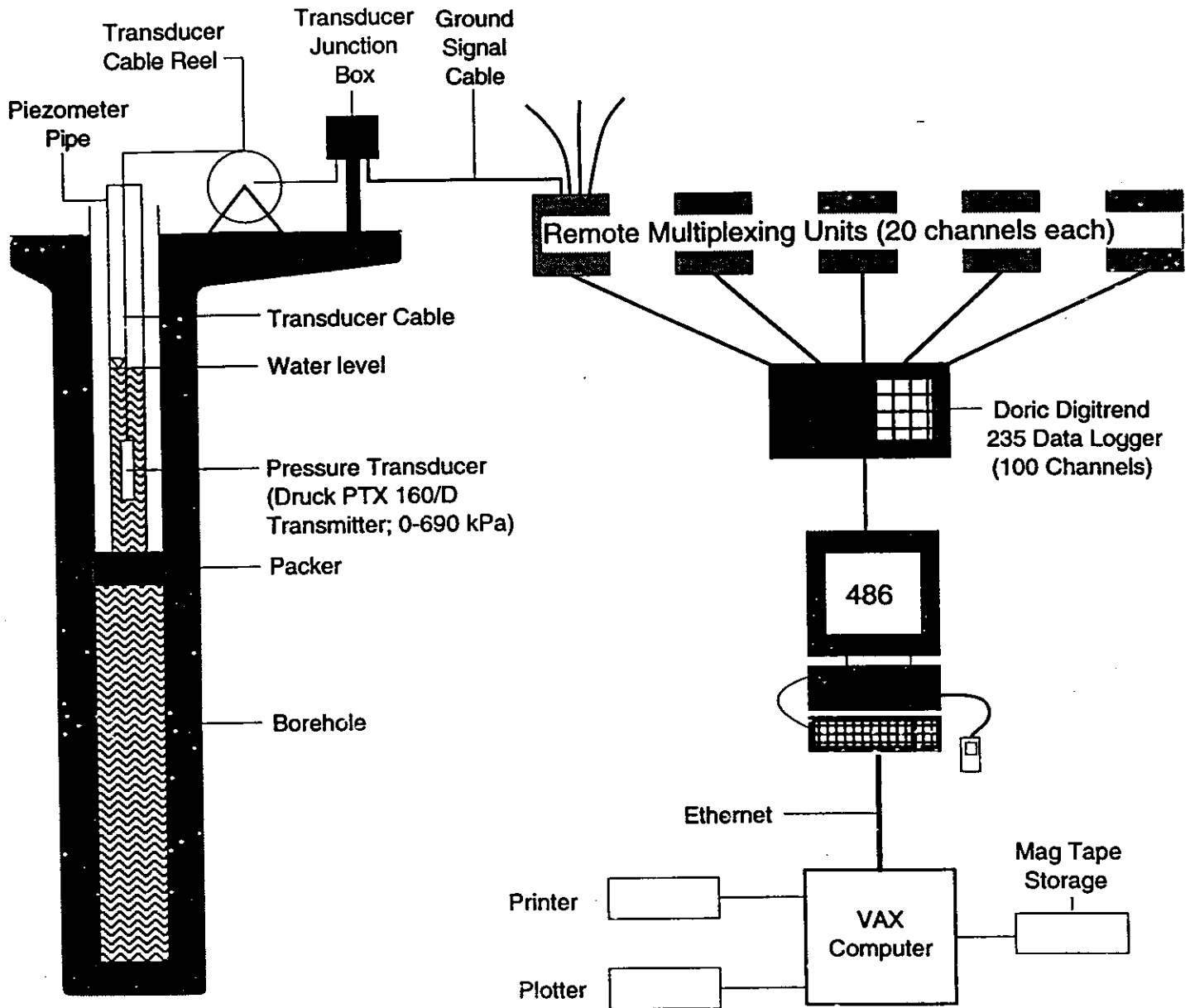

FIGURE A27: Flow Chart Showing the Data Collection Path

Hydrogeology Data Acquisition System (HDAS) Surface Boreholes



Number of Channels Presently Scanned

77

Scan Rates: Normal - 1 Scan per hour

Fast - 1 Scan per minute

CANDIDATE AREA CHARACTERIZATION :

- *OPTIMIZING SITE CHARACTERIZATION COSTS*
- *REMOTE SENSING, AIRBORNE SURVEYS, AND RECONNAISSANCE MAPPING*
- *BOREHOLE SITING, DRILLING AND LOGGING, AND TESTING*
- *PIEZOMETER CONSTRUCTION AND MONITORING*
- *GROUNDWATER SAMPLING*
- *DATA COLLECTION, ANALYSIS AND ARCHIVING*
- *CONCEPTUAL HYDROGEOLOGIC MODEL CONSTRUCTION*



CONCEPTUAL HYDROGEOLOGIC MODEL CONSTRUCTION:

- *CONCEPTUAL MODEL SCALE AND BOUNDARY CONDITIONS*
- *HYDROSTRATIGRAPHIC UNIT CHARACTERISTICS*
- *HYDRAULIC HEAD DISTRIBUTION*
- *MATHEMATICAL MODEL REQUIREMENTS*



CONCEPTUAL MODEL SCALE AND BOUNDARY CONDITIONS

CONCEPTUAL MODEL SCALE:

*REGIONAL: to include the boundaries of the selected Candidate Areas
($> 400 \text{ km}^2$);*

LOCAL: to include the boundaries of the selected Candidate Sites ($\sim 25 \text{ km}^2$)

CONCEPTUAL MODEL BOUNDARY CONDITIONS:

*REGIONAL: to coincide with regional catchment boundaries around
the selected Candidate Areas;*

*LOCAL: to coincide with the boundaries of the selected Candidate Sites (to
be selected from the mathematical hydrogeologic model)*



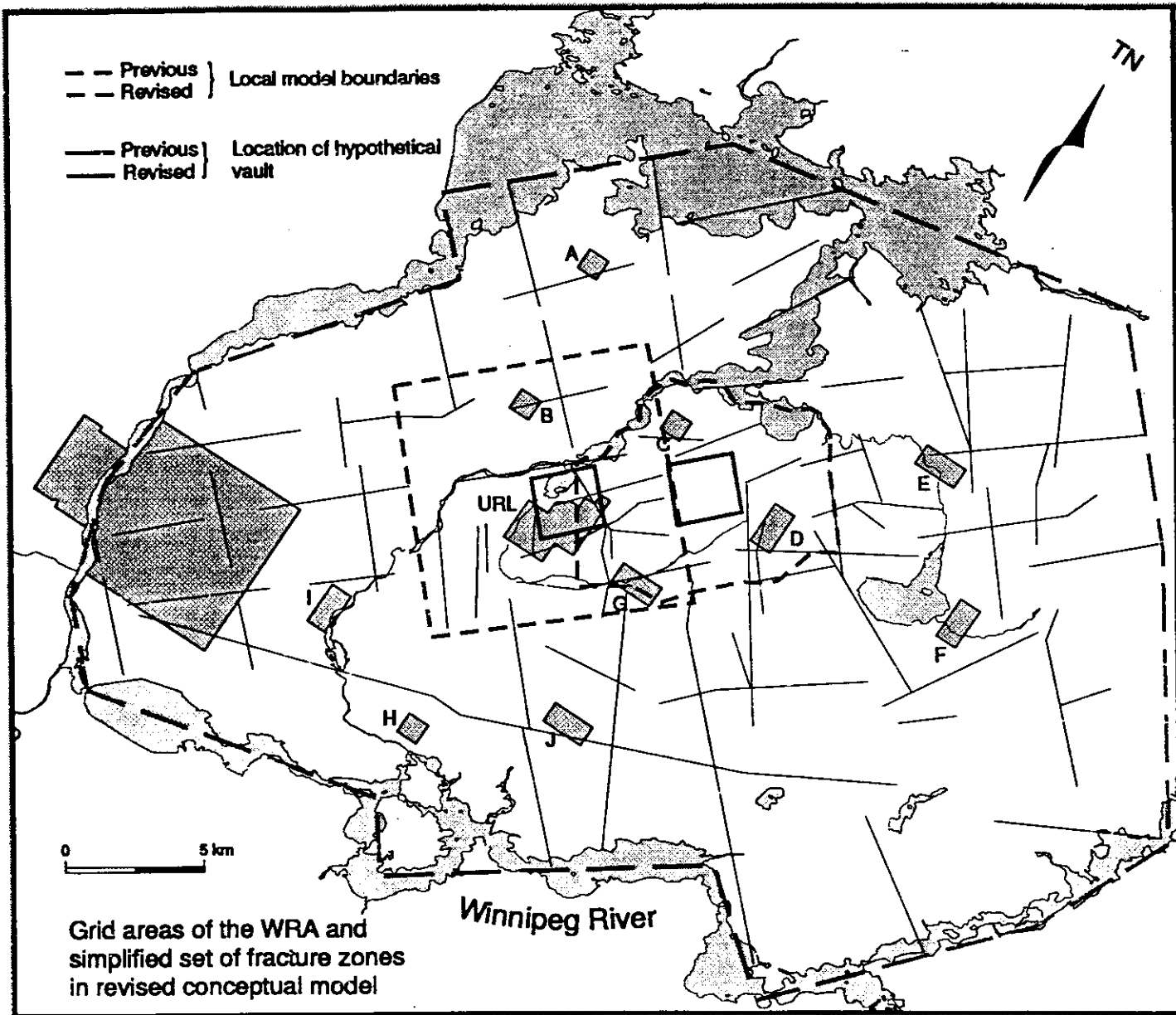

Grid areas of the WRA and simplified set of fracture zones in revised conceptual model

HYDROSTRATIGRAPHIC UNIT CHARACTERISTICS

HYDROSTRATIGRAPHIC UNITS: are geologic domains with similar hydraulic properties

HYDRAULIC PROPERTIES:

PERMEABILITY; m^2

EFFECTIVE POROSITY: drainable rock-mass pore volume / total rock-mass volume

COMPRESSIBILITY: $1 / Pa$, or m^2 / N

GEOMETRY: *REGIONAL SCALE* : hydrostratigraphic units extend for 1000s to 10 000s m (across Candidate Area);

LOCAL SCALE (FAR FIELD): hydrostratigraphic units extend for 10s to 100s m (across Candidate site);

LOCAL SCALE (NEAR FIELD): hydrostratigraphic units extend for 1 to 10s m



WD3 GEOPHYSICAL AND FRACTURE LOGS AND FRACTURED ROCK TYPE

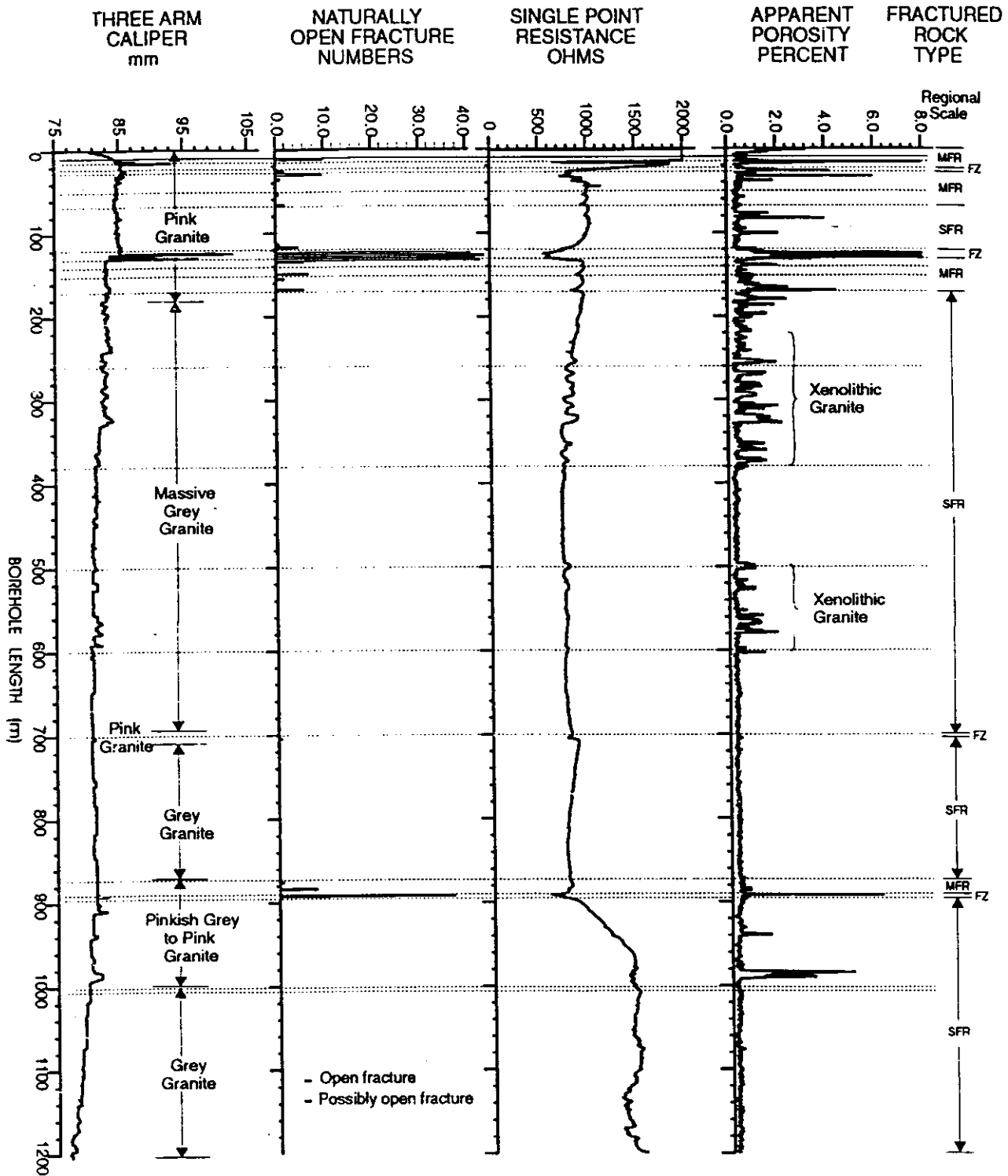

Figure 4: Selected Geophysical Signatures of Logged-Open Fractures and Fractured Rock Domains in Borehole WD3

WG4 GEOPHYSICAL AND FRACTURE LOGS AND FRACTURED ROCK TYPE

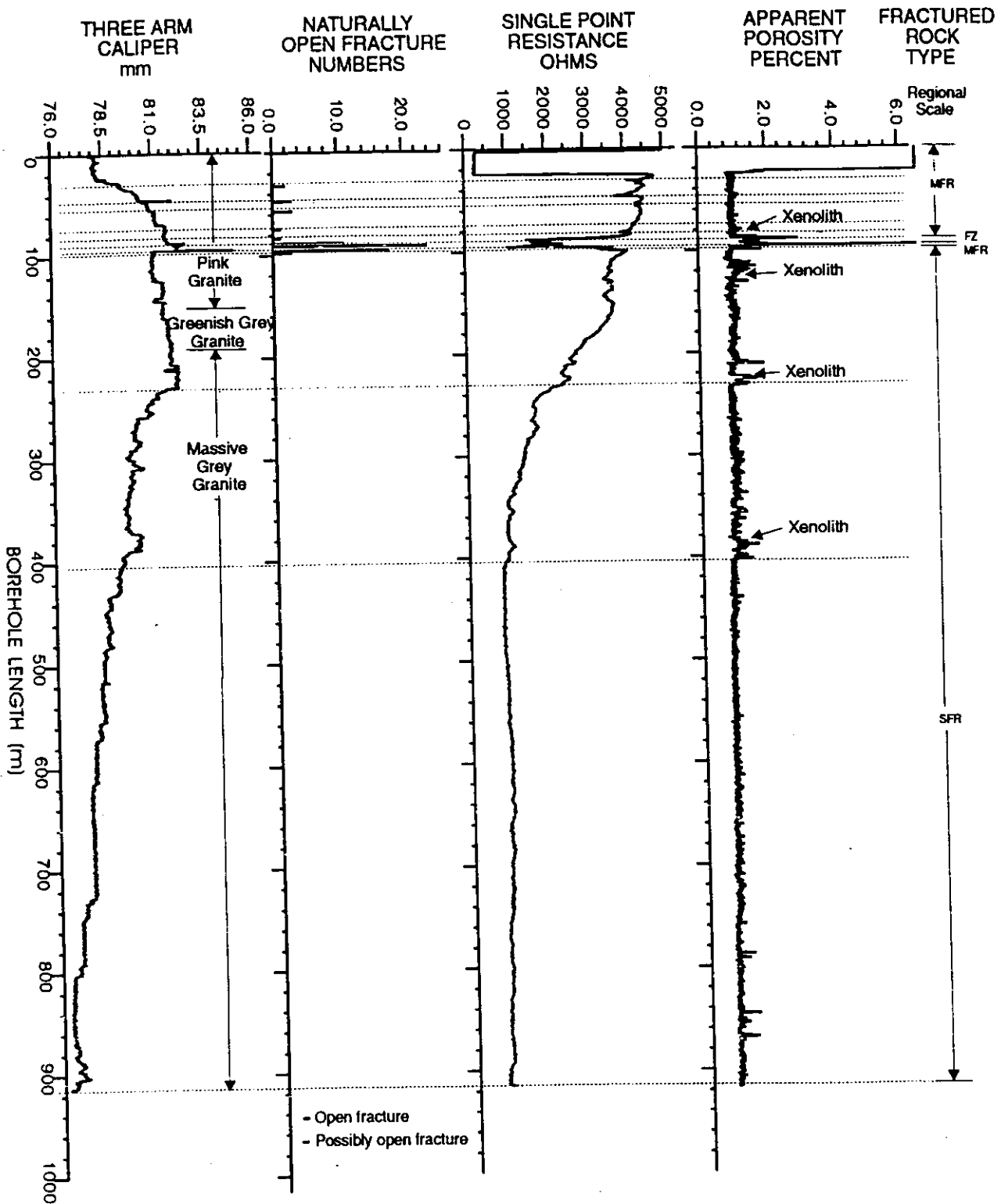
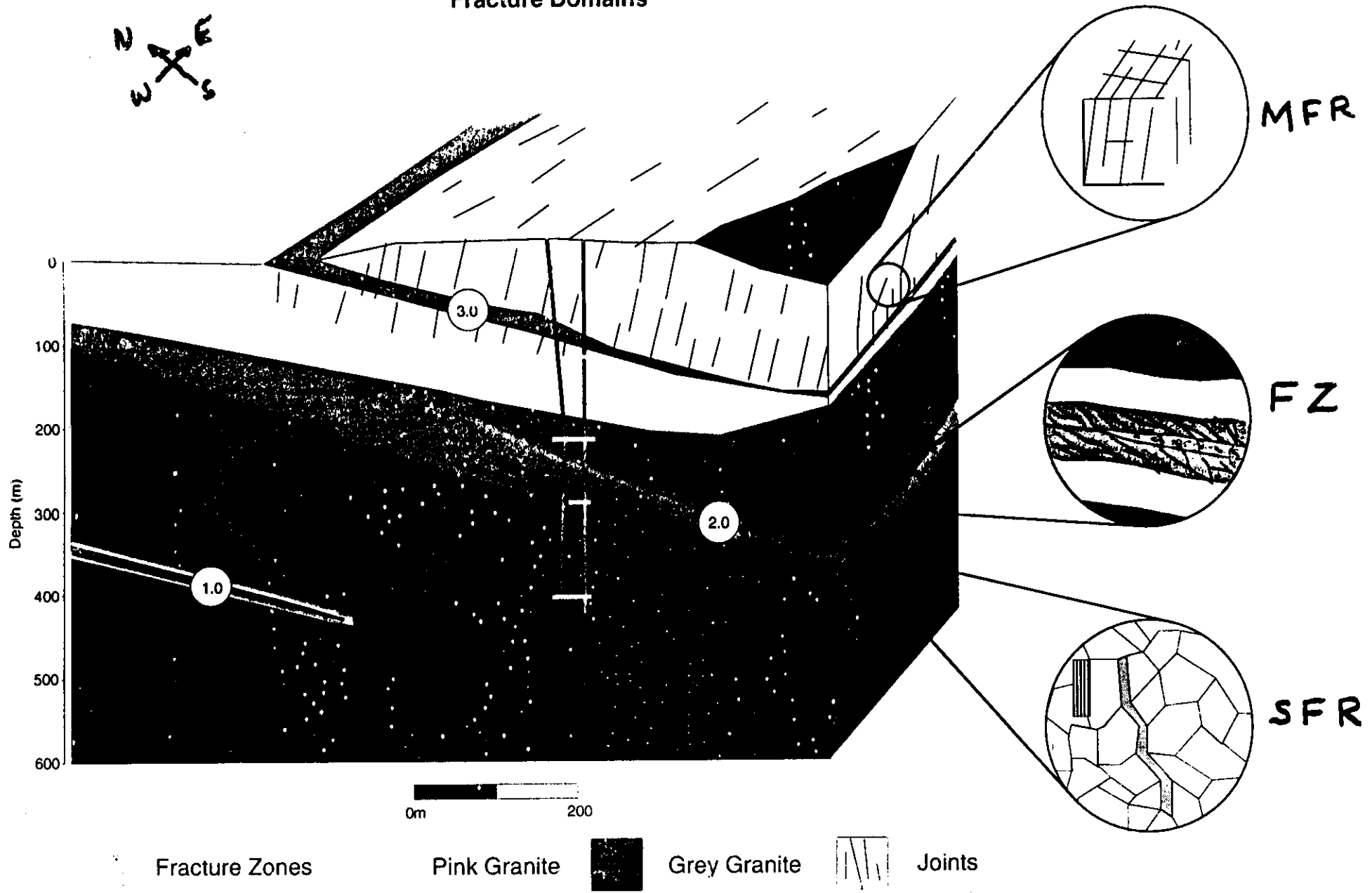

Figure 5: Selected Geophysical Signatures of Logged-Open Fractures and Fractured Rock Domains in Borehole WG4

Fracture Domains



HYDRAULIC HEAD DISTRIBUTION

*UPPER BOUNDARY: STEADY STATE (specified head: Dirichlet);
TRANSIENT (specified flux: Neumann)*

LATERAL BOUNDARY:

*SPECIFIED HEAD (Dirichlet condition);
SPECIFIED FLOW (Neumann condition);
MIXED (combination of both)*

LOWER BOUNDARY: NO FLOW (permeability barrier)



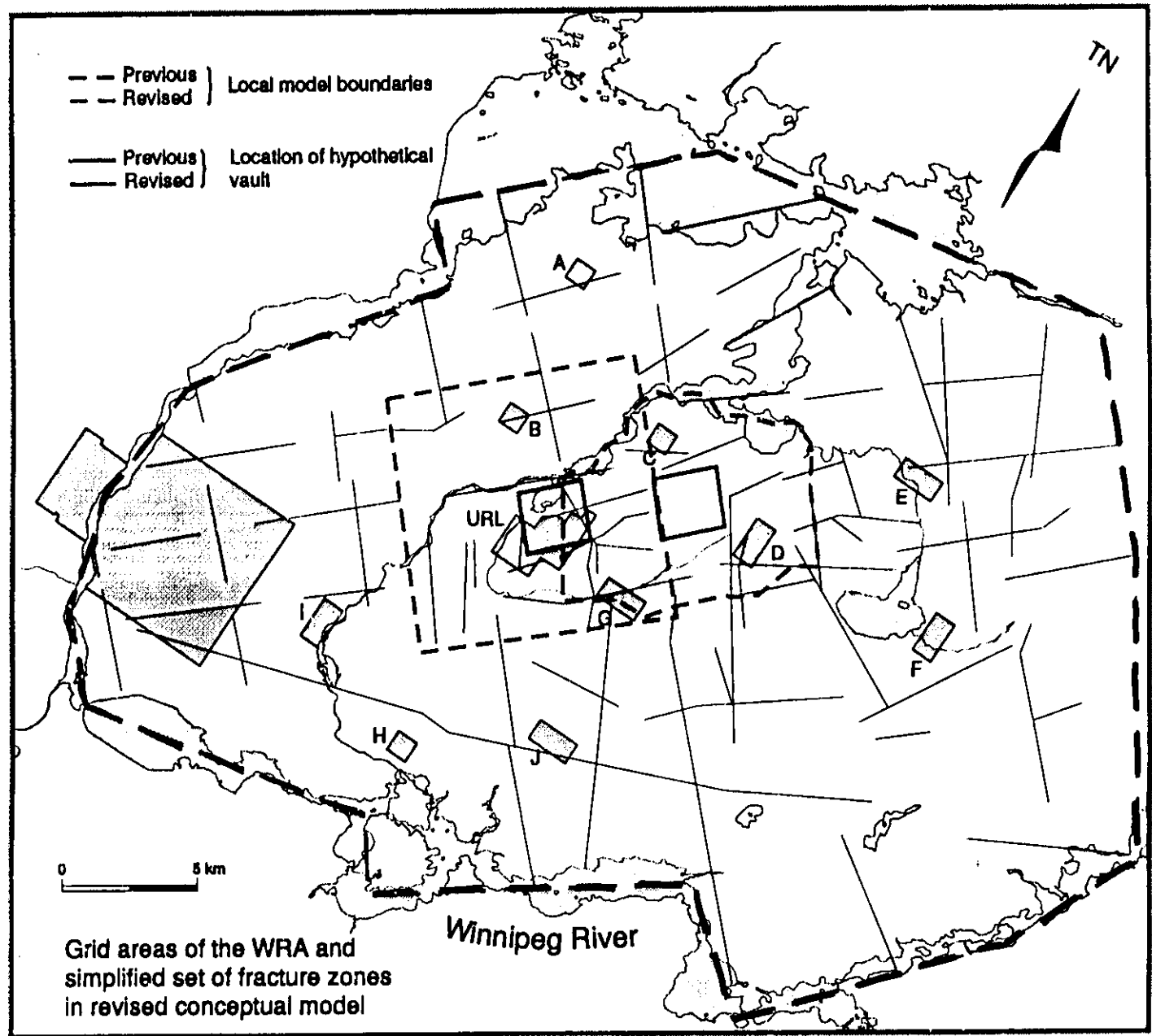





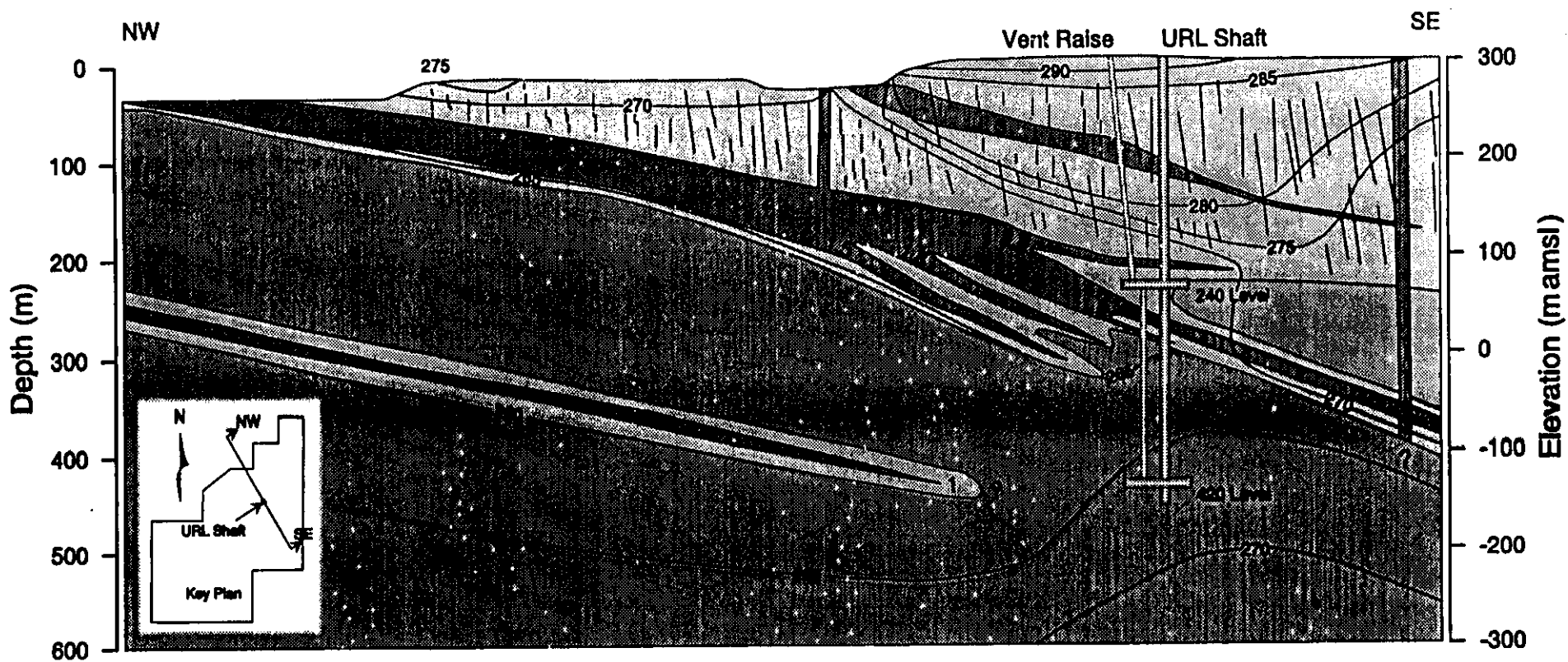

Grid areas of the WRA and simplified set of fracture zones in revised conceptual model



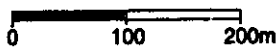

-  Fracture Zones
-  Grey Granite
-  Pink Granite



-  Hydraulic Head (H 1.00) Pre-Excavation
-  Vertical Fracturing
-  Fracture Zone Designation

MATHEMATICAL MODEL REQUIREMENTS

MODEL GEOMETRY: *STEADY STATE; TRANSIENT*

MODEL GEOMETRY:

*Boundaries coincide with conceptual model;
model layering coincides with hydrostratigraphic units
given in conceptual hydrogeologic model.*

MODEL COMPONENTS: *solid elements representative of the rock mass;
planar elements representative of the fracture zones (FZs);
rod-shaped elements representative of fracture zone
intersections or channels within FZs where required.*

CODE: *AECL uses the 3 - D finite element code MOTIF which simulates
the coupled processes of:*

*groundwater flow;
heat transport;
and solute transport*



GEOSPHERE MODELLING APPROACH

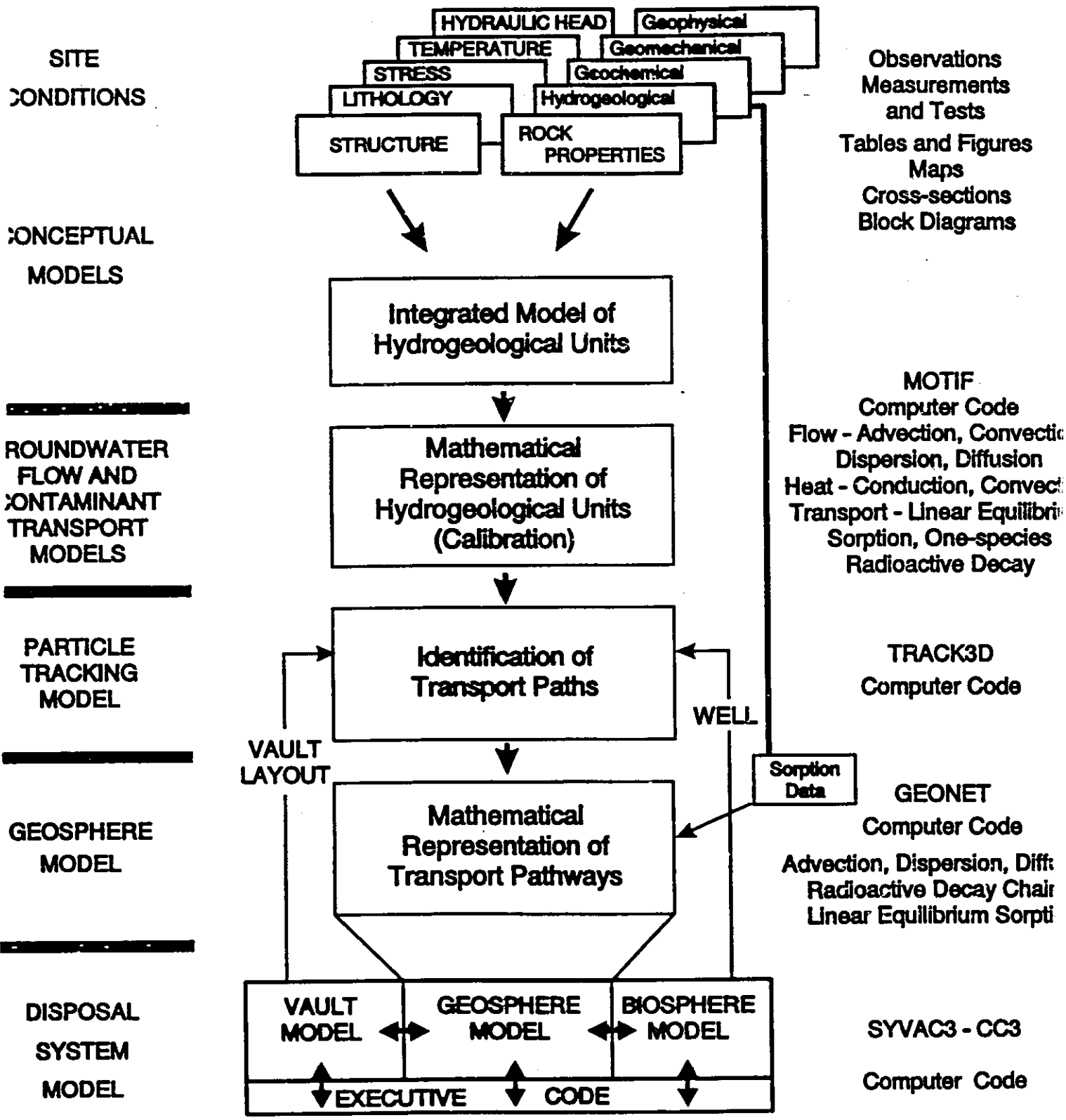

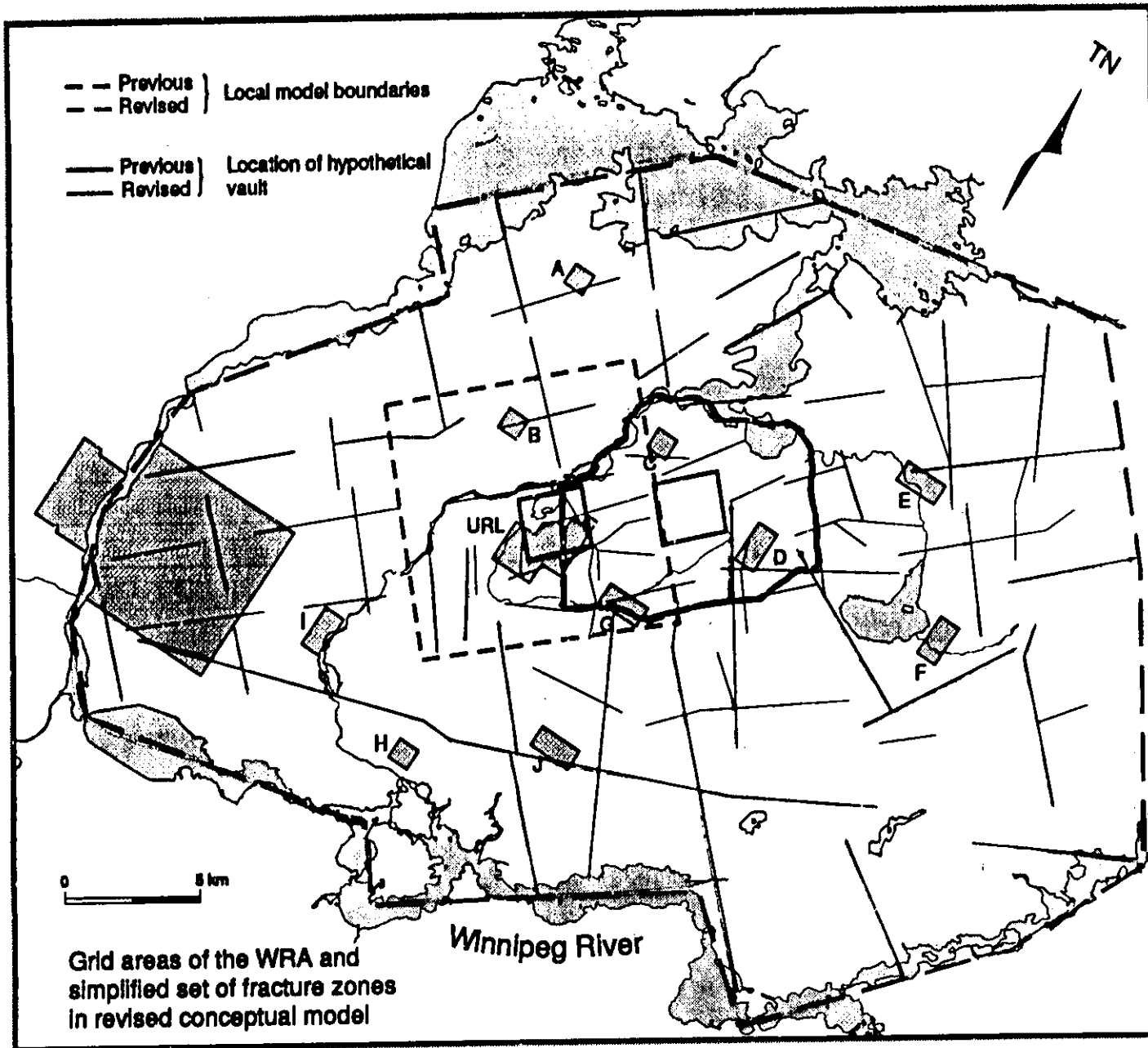

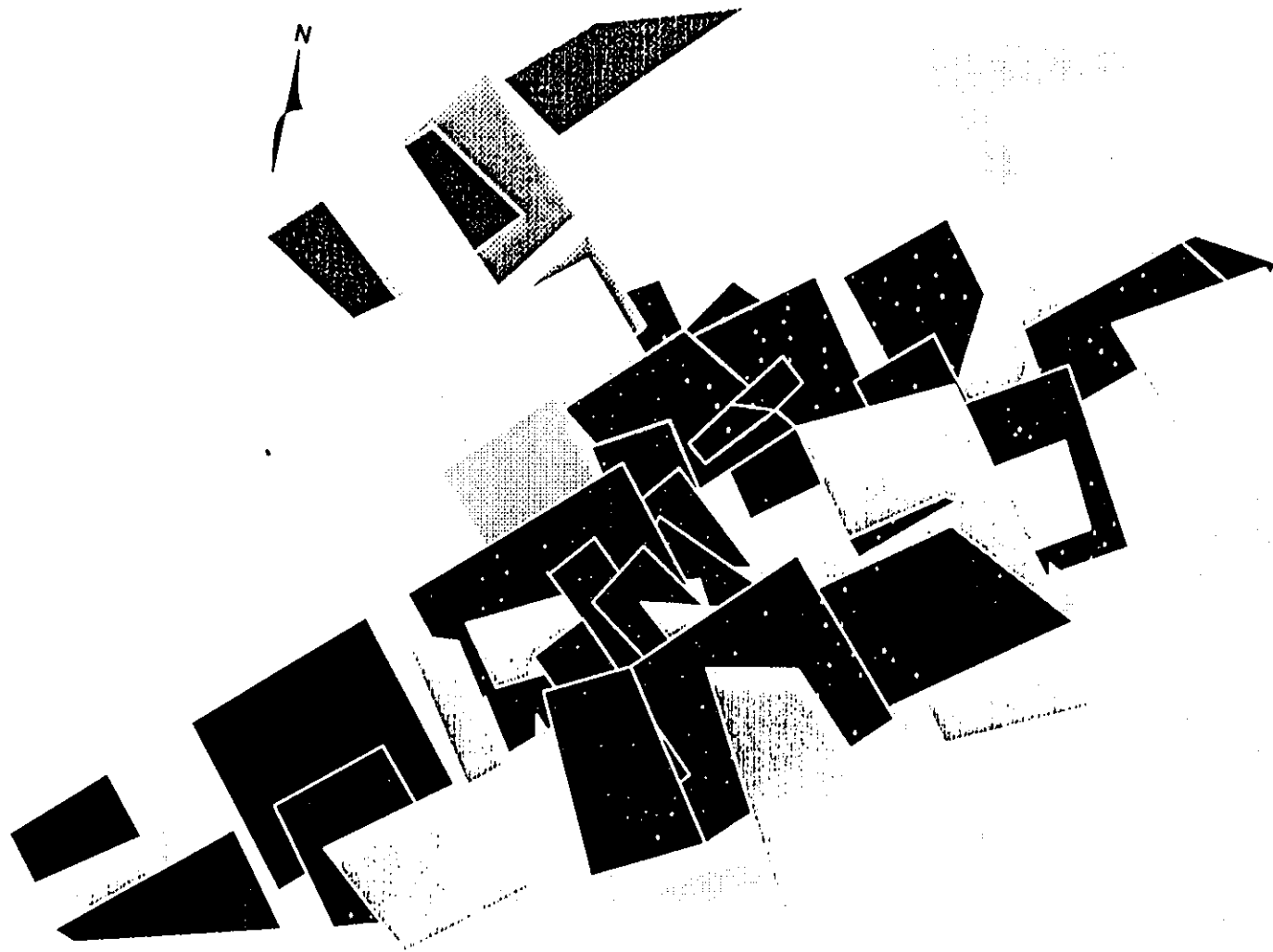

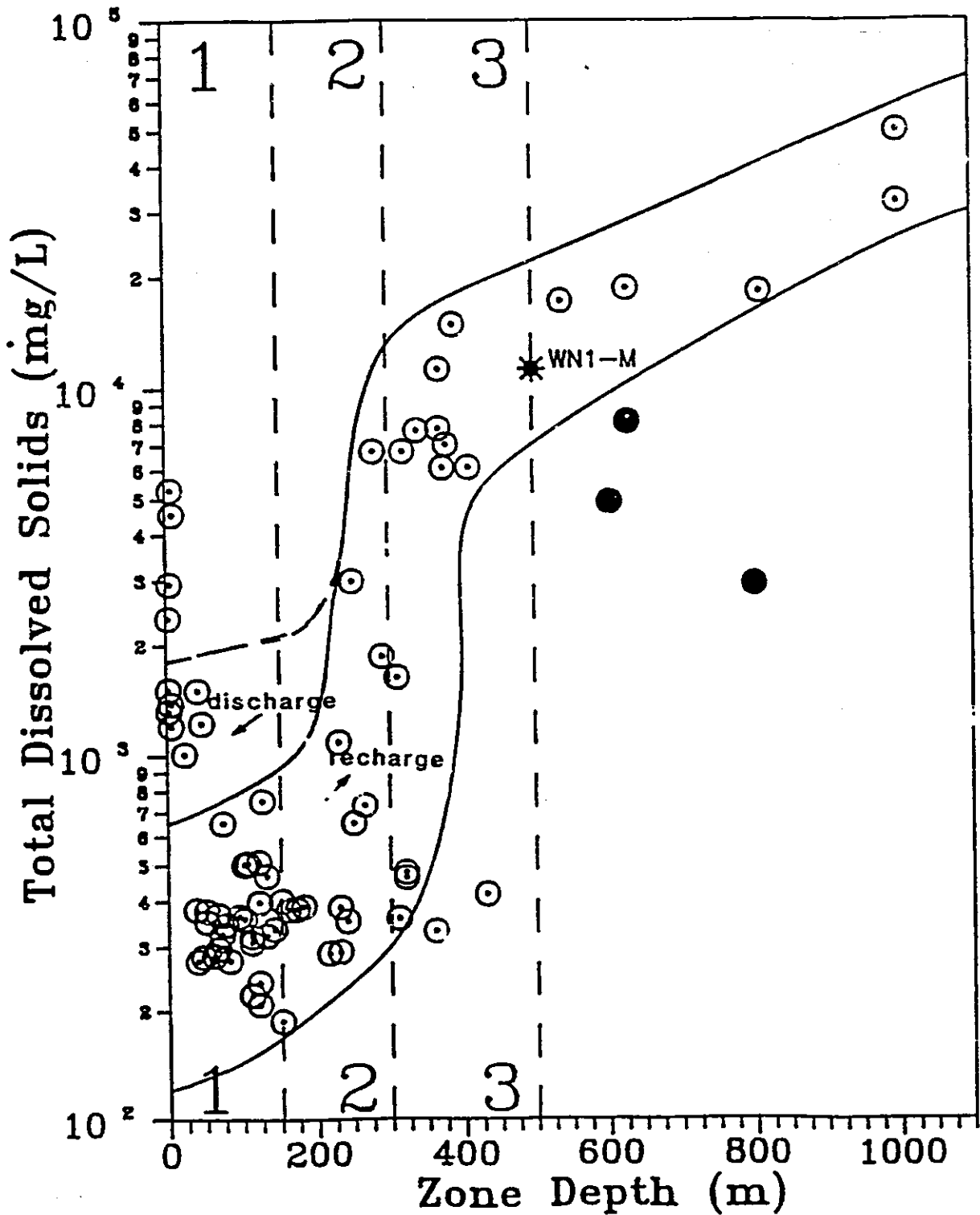

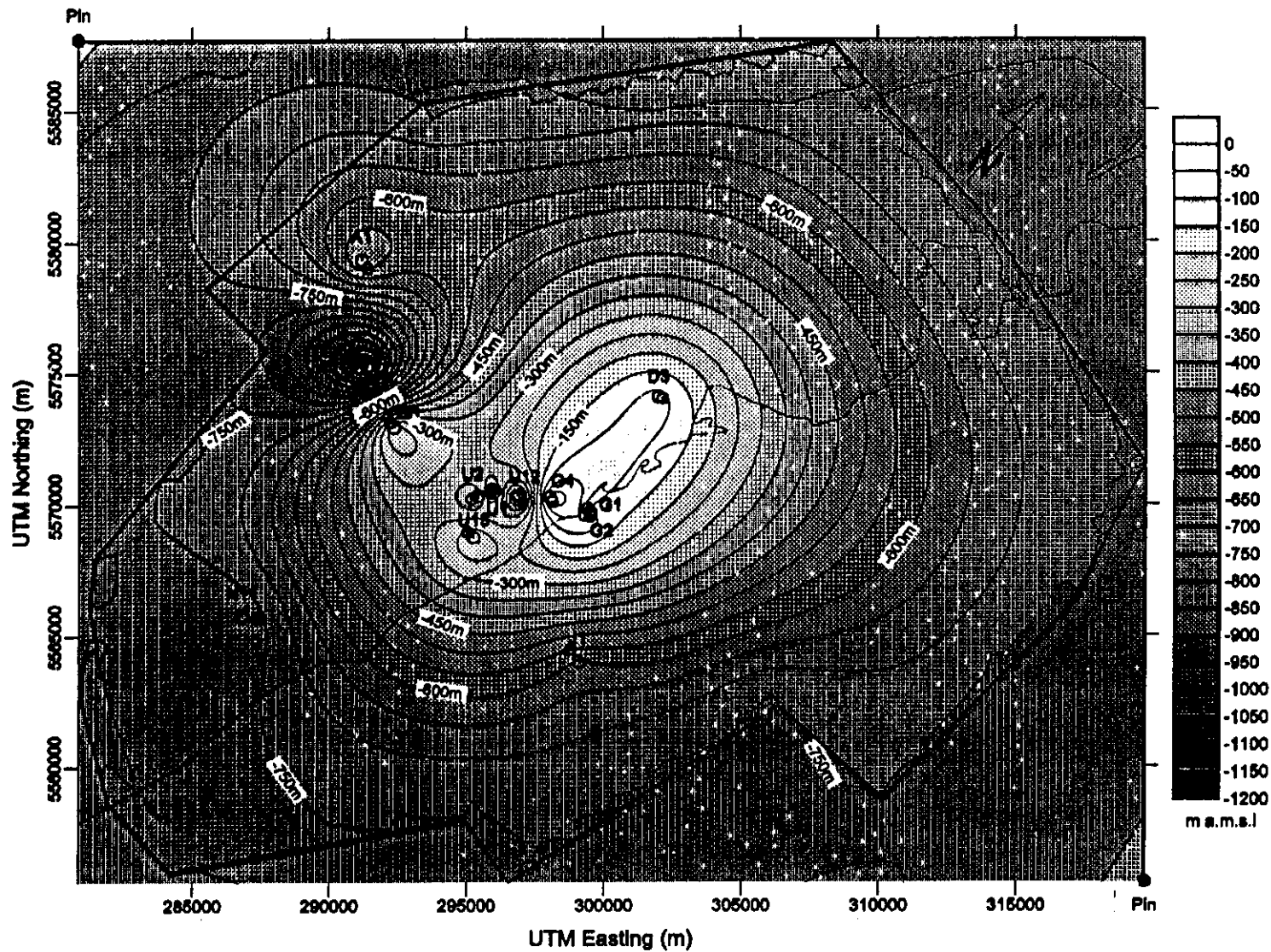

Notes: Black circles are borehole collars, and blue circles are the borehole intersections with sparsely fractured rock domain projected to ground surface

Figure 5: Structure contour map at the upper surface of the domain of massive sparsely fractured grey granite rock in the Whiteshell research Area (after Figure 12 Ophori et al, 1995)

REVISED WRA CONCEPTUAL MODEL FRACTURE ZONE AND ROCK MASS POROSITY & PERMEABILITY DISTRIBUTIONS

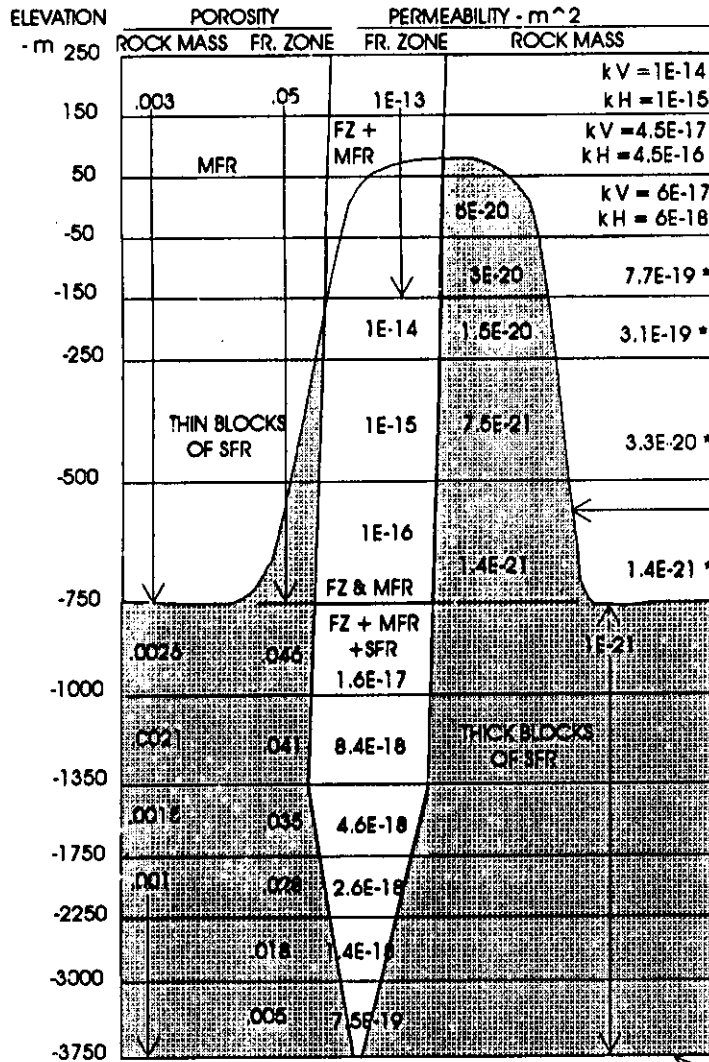

NOTES: 1) k = permeability, n = porosity
* vertical k of gneisses = horizontal k x 10

REVISED WRA CONCEPTUAL MODEL FRACTURE ZONE AND ROCK MASS SALINITY DISTRIBUTIONS

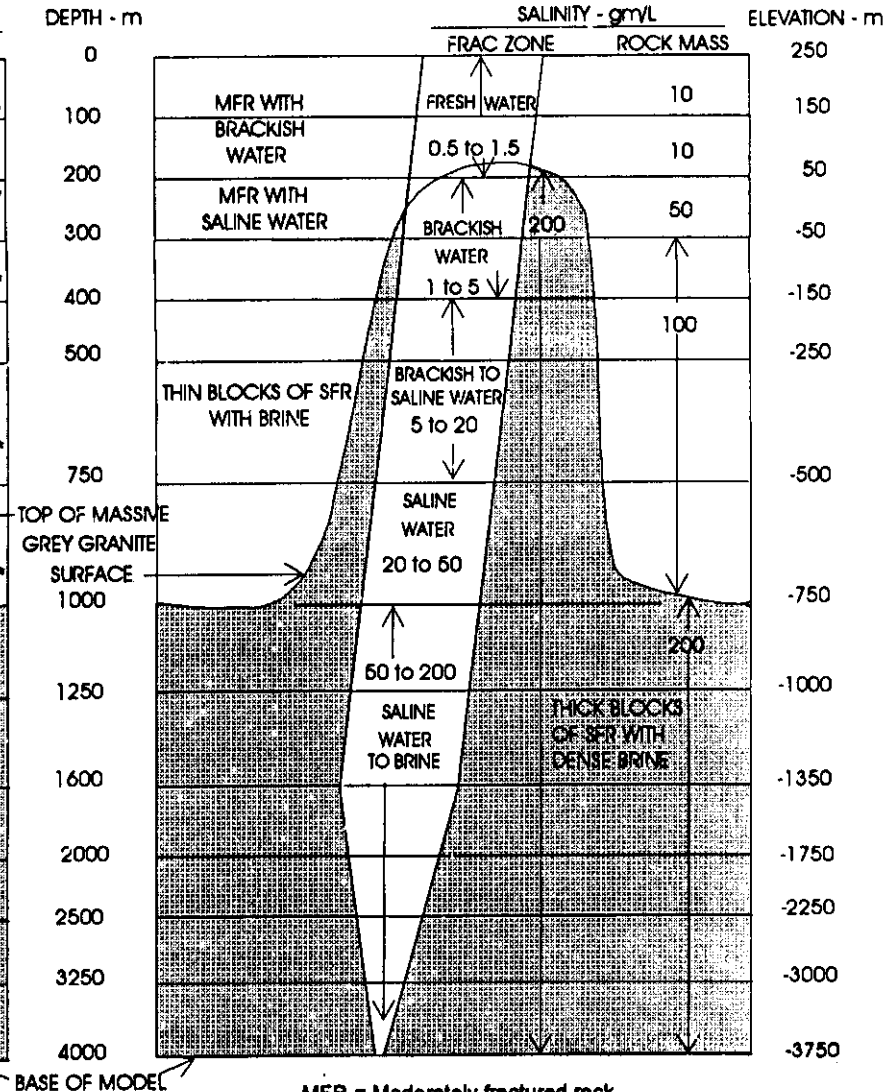

MFR = Moderately fractured rock
SFR = Sparsely fractured rock
FZ = Fracture zone

Figure 12: Permeability, Porosity and Salinity Distributions in the Revised Conceptual Hydrogeologic Model

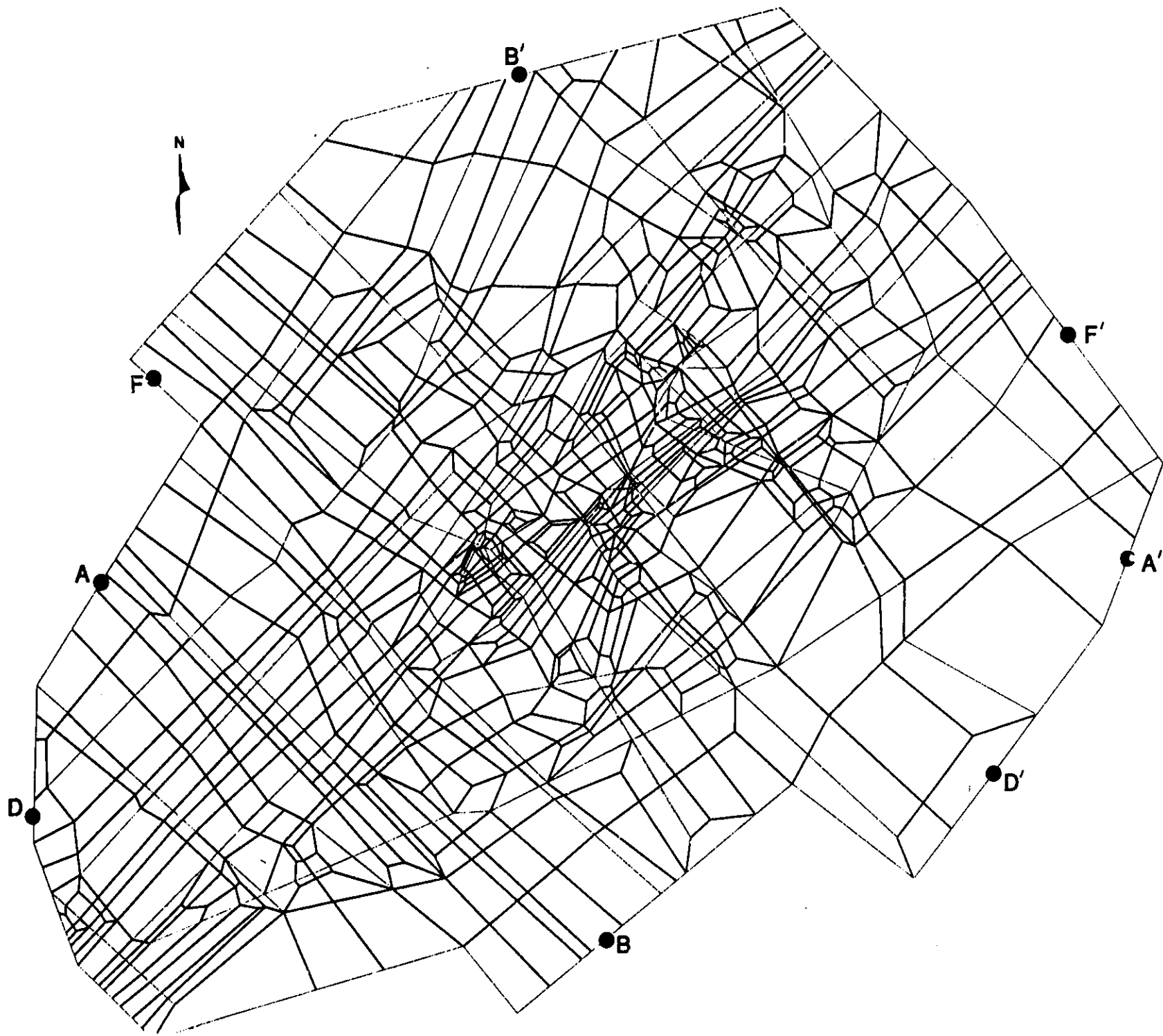

HYDROGEOLOGICAL ASPECTS:

- *HOST AREA SCREENING*
- *POTENTIAL CANDIDATE AREA EVALUATION*
- *CANDIDATE AREA CHARACTERIZATION*
- *FAVOURABLE CANDIDATE SITE CHARACTERISTICS*
- *CANDIDATE SITE CHARACTERIZATION*
- *RESEARCH AND DEVELOPMENT*



FAVOURABLE CANDIDATE SITE CHARACTERISTICS

- *LARGE REGIONS OF LOW PERMEABILITY ROCK BELOW 500 M*
- *LONG NATURAL GROUNDWATER FLOW PATHWAYS FROM BELOW 500 M DEPTH AND GROUND SURFACE*
- *VERY REDUCING GROUNDWATER CONDITIONS*
- *LOW HORIZONTAL INSITU STRESS AND H:V STRESS RATIO*
- *ABSENCE OF OVERLYING DEEP HIGH-YIELD WATER WELLS*
- *BELOW FRESH WATER / SALT WATER INTERFACE*



HYDROGEOLOGICAL ASPECTS:

- *HOST AREA SCREENING*
- *POTENTIAL CANDIDATE AREA EVALUATION*
- *CANDIDATE AREA CHARACTERIZATION*
- *FAVOURABLE CANDIDATE SITE CHARACTERISTICS*
- *CANDIDATE SITE CHARACTERIZATION*
- *RESEARCH AND DEVELOPMENT*

