

PI 30.23-2

Electrical Equipment - Course PI 30.2

GENERATOR AUXILIARY SYSTEMS

OBJECTIVES

On completion of this module the student will be able to:

1. State the purpose of the generator stator cooling system.
2. List and briefly explain five operational requirements of the generator stator cooling system.
3. Given a simplified diagram of a typical stator cooling system:
 - a) Label each flagged component;
 - b) Identify the flow direction of the demineralized cooling water using arrows.
 - c) Briefly explain the function of each component in a stator cooling system.
4. State the purpose of the generator hydrogen seal.
5. State three operational requirements of the generator hydrogen seal.
6. Given a cross-sectional diagram of a typical generator hydrogen seal:
 - a) Briefly explain its operation;
 - b) State the direction of flow of the seal oil within the seal.
7. State the purpose of the generator hydrogen seal oil system.
8. List and briefly explain six operational requirements of the generator hydrogen seal oil system.
9. Given a simplified diagram of a typical generator hydrogen seal oil system:
 - a) Label the flagged components correctly;
 - b) Briefly explain the function of each component.
10. State the purpose of the generator hydrogen cooling system.
11. List and briefly explain seven operational requirements of a generator hydrogen cooling system.

PI 30.23-2

12. Given a simplified diagram of a large AC generator:
 - a) Label the components related to, or cooled by the hydrogen cooling system;
 - b) Briefly explain the function of each of the components you identified in (a).
 - c) Indicate with arrows, the flow paths of the hydrogen gas.
13. List and briefly explain six precautions with respect to the generator auxiliary systems discussed in objectives 1 to 13 inclusive.
14.
 - a) List and briefly explain five advantages of choosing hydrogen rather than air as a cooling medium for large generators;
 - b) List and briefly explain two disadvantages of choosing hydrogen rather than air as a cooling medium for large generators.

1.0 INTRODUCTION

This module will introduce the trainee to:

- (a) The generator stator cooling system.
- (b) The generator hydrogen seal.
- (c) The generator hydrogen seal oil system.
- (d) The generator hydrogen cooling system.
- (e) Precautions relating to generator cooling systems.
- (f) The advantages and disadvantages of hydrogen, compared to air, as a coolant.

2.0 THE GENERATOR STATOR COOLING SYSTEM

2.1 Purpose of The Generator Stator Cooling System

The purpose of the generator stator cooling system is to maintain the copper stator bars and the end core magnetic screen plates within their proper operating temperature range under all operating conditions, by passing cooled, demineralized water through them.

2.2 Operational Requirements of the Generator Stator Cooling System

To ensure safe operation of the generator, five operational requirements must be met. These are:

- (i) To provide demineralized cooling water to the generator stator windings and the end core magnetic screen plates, at a controlled pressure below that of the hydrogen pressure, thereby ensuring that any leaks which may occur will result in hydrogen gas entering the stator coolant rather than water entering the generator.
- (ii) To detect and alarm if the conductivity of the demineralized water goes up to an unsafe level. The demineralized water must not allow any fault to ground.
- (iii) To provide filtration to remove any particulates which could plug the very small bores of the stator tubes.
- (iv) To provide venting to atmosphere for any hydrogen gas that becomes entrained in the stator coolant.
- (v) To provide for addition of demineralized coolant into a head tank to make up for any loss due to leaks or evaporation from the stator cooling system.

2.3 A Typical Stator Cooling System

Figure 2 is a simplified diagram of a typical stator cooling system, showing typical system components and the direction of the coolant flow. The following are brief explanations of the functions of the major components of the system:

(i) ac Pumps - PM 1, PM 2

Two 100% duty pumps, operating on Class IV ac power, are provided. Either of these pumps can provide 100% of the required flow. Therefore, one pump is in service and the other is on standby.

(ii) Emergency Pump - PM 3

The emergency pump is a 50% duty pump, meaning it is capable of supplying only 50% of the required full power flow. It is powered from Class I and starts automatically if both ac pumps fail. Some stations may not have an emergency pump.

(iii) Check Valves - NV24 and Others

Various check valves are provided to prevent reverse rotation of the pumps and to ensure correct flow direction of the stator coolant.

(iv) Stator Water Coolers - HX1, HX2

In order to minimize demineralized water cost and to prevent ingress of impurities, the demineralized water is recirculated through the stator conductors and the cooling system in a closed loop. Two 100% duty heat exchangers, cooled by low pressure service water, are provided in a parallel configuration. These heat exchangers are vented at their high points.

(v) Strainer and Filter - STR1, FR1

A strainer and filter are provided to remove any particulates from the coolant. Both may be instrumented for differential pressure drop across them and bypassed for maintenance.

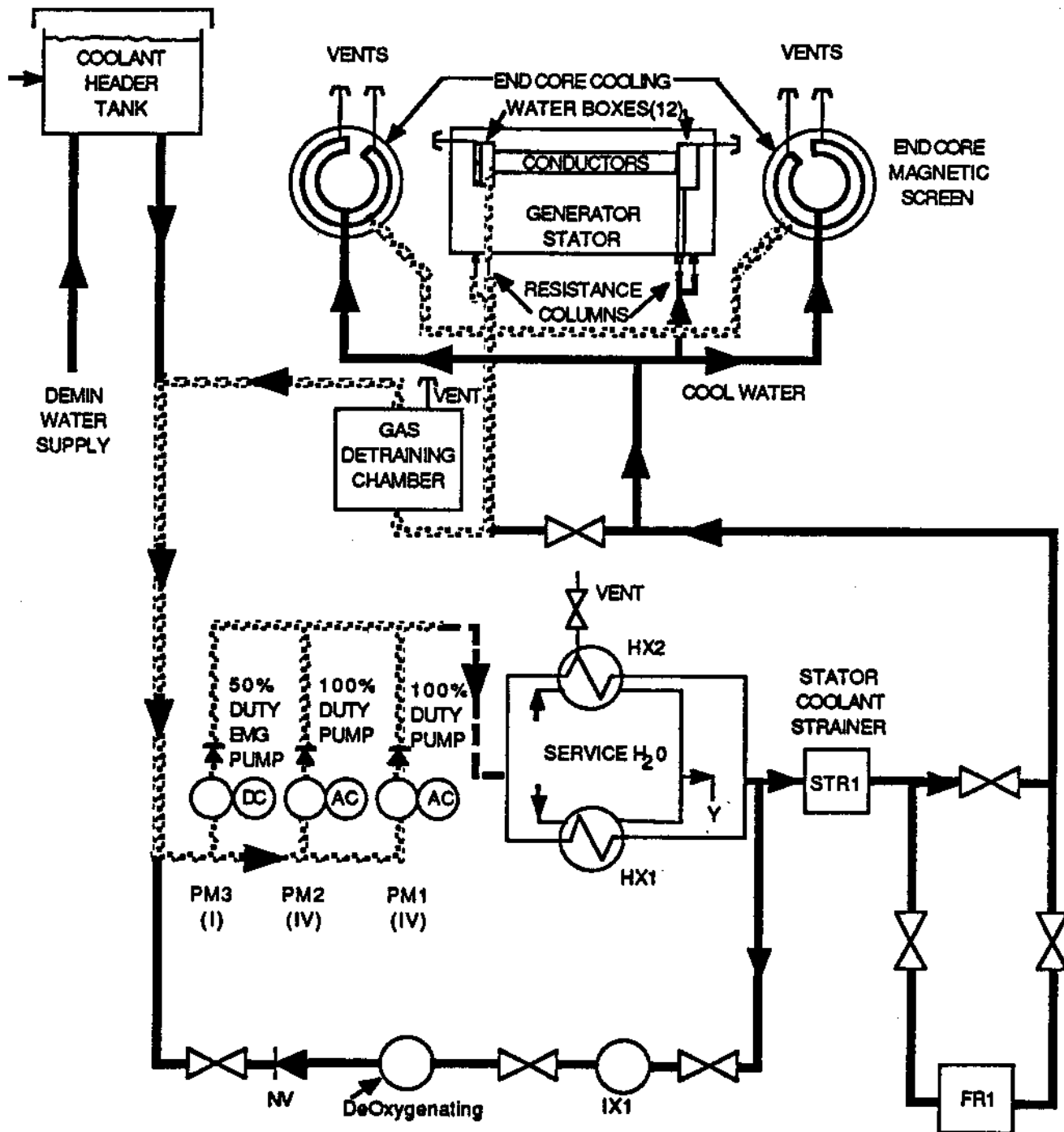

Figure 2: Simplified Diagram of a Typical Stator Cooling System

(vi) Deoxygenating Unit and IX Column - IX1

In order to provide the required insulating properties, the stator water conductivity must be held below preset limits. A typical operating conductivity is in the 0.5 $\mu\text{s}/\text{cm}$ range. Since conductivity will tend to rise during operation, an IX column and deoxygenating unit are provided to scrub the demineralized water circulating in the stator cooling system.

(vii) Vents

Vents are provided as shown, at various high points in the stator cooling system, to permit bleeding off of any gases (O_2 , N_2 , H_2) that might accumulate and cause an "air-lock" to form.

(viii) Coolant Header Tank

The coolant header tank holds a supply of demineralized water at a relatively constant head pressure for the stator coolant system. It is important to keep the stator cooling system filled with demineralized water in order to minimize the corrosion and other forms of contamination that will arise if the stator cooling system is repeatedly opened to the atmosphere.

(ix) Resistance Columns

The resistance columns carry the stator cooling water into or out of the generator while electrically isolating the stator cooling system from the stator conductors. Stator conductor voltages are as high as 24 kV.

(x) Gas Detraining Chamber

The heated outflow from the stator conductors and the end core magnetic screen plates at each end of the generator goes to the gas detraining chamber. Any hydrogen that may have leaked into the demineralized cooling water ($\text{PH}_2 > \text{PH}_2\text{O}$) is separated and vented to atmosphere.

3.0 THE GENERATOR HYDROGEN SEAL

3.1 Purpose of the Generator Hydrogen Seal

Hydrogen seals are provided at each end of the generator to ensure that there is a minimum of hydrogen leakage between the rotating generator shaft and the stationary end cover of the stator. This requires maintaining a continuous seal for operating periods of a year or more, at hydrogen working pressures of 300 - 400 kPa(g), at generator rotor speeds ranging from stationary to 1 800 RPM.

3.2 Operational Requirements of a Generator Hydrogen Seal

Three operational requirements of a generator hydrogen seal are:

- (i) It must provide a seal between the generator rotor and the stationary end cover of the generator.
- (ii) It must accommodate significant axial movement of the rotor shaft with respect to the generator end cover.
- (iii) It must minimize the ingress of oil and/or air to the generator cavity.

3.3 A Typical Generator Hydrogen Seal

Figure 3 is a simplified sectional diagram of a typical generator hydrogen seal. The cool, clean seal oil is supplied to the stationary oil feed chamber at a pressure somewhat greater than the hydrogen pressure in the generator. A preset spring loading, aided slightly by the oil pressure provides an axial force which continuously holds the seal ring toward the shaft ring face. On the front of the seal ring is the soft metal continuous seal face. The oil pressure causes the seal oil to flow through the oil ports to the continuous seal face, where the majority of the oil flows outwards between the seal face and the seal ring and the remainder flows inwards toward the rotor shaft. This flow pattern results in a continuously oil wetted and cooled seal between the rotor shaft and the generator end cover.

Most of the oil flow is required for lubrication and cooling of the seal face. After flowing outwards to the low pressure side of the seal, it is discharged to the bearing drains in the bearing pedestal. Since the oil flow to the hydrogen side is small, the quantity of entrained air released into the hydrogen is very small. It is, therefore, not necessary to vacuum treat the seal oil to remove entrained air. Hydrogen purity is normally maintained without extensive make-up. The small amount of oil which flows to the hydrogen side is drained to the hydrogen detrainning tank.

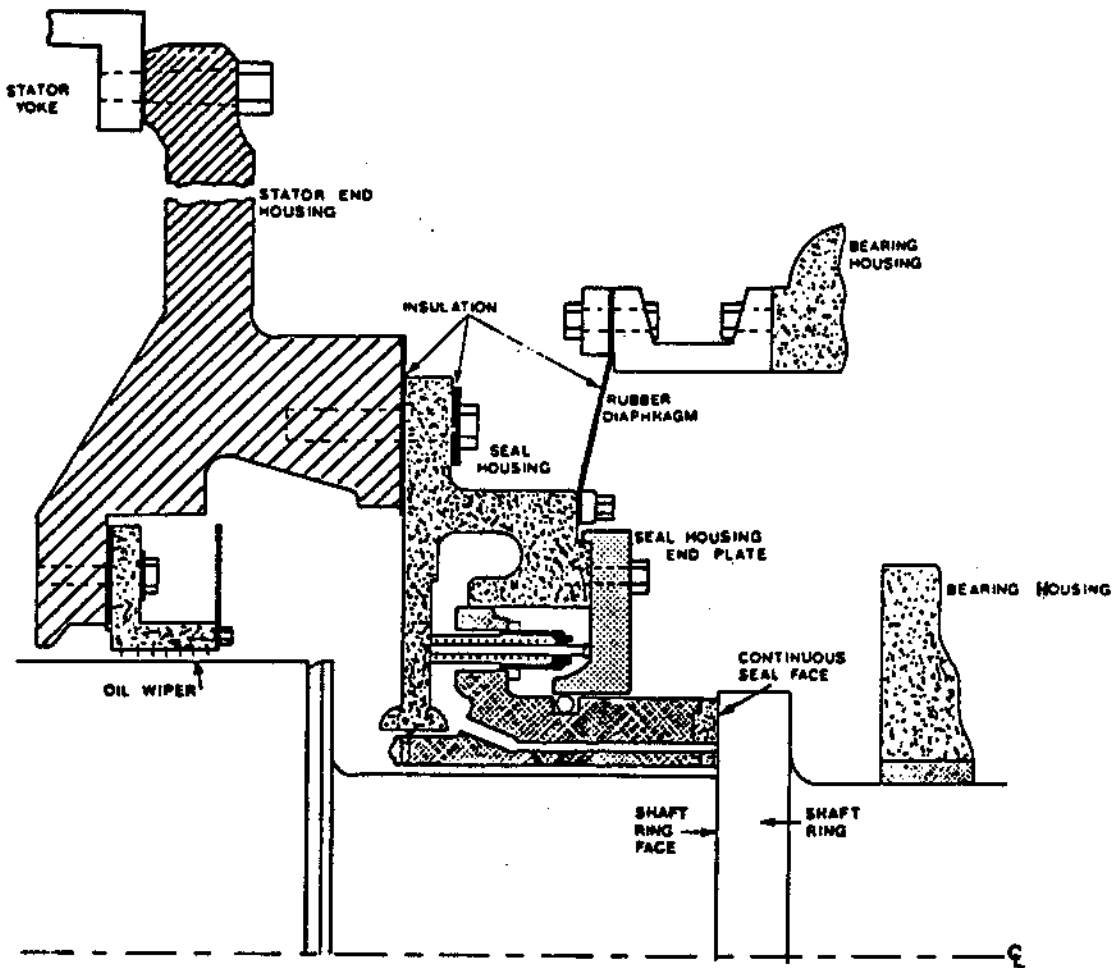

Figure 3: A Section of a Typical Generator Seal

3.4 Radial Hydrogen Seals

The radial oil seal shown in Figure 4 is a newer form of hydrogen seal having no soft metal seal faces. Oil is pumped toward the shaft from two sets of holes in a stationary ring surrounding the generator shaft, forming two rings of oil between the moving shaft and the stationary ring. A central vacuum ring extracts the oil from the seal area. These rings of oil accommodate both axial and radial shaft movement while continuously sealing the hydrogen within the generator.

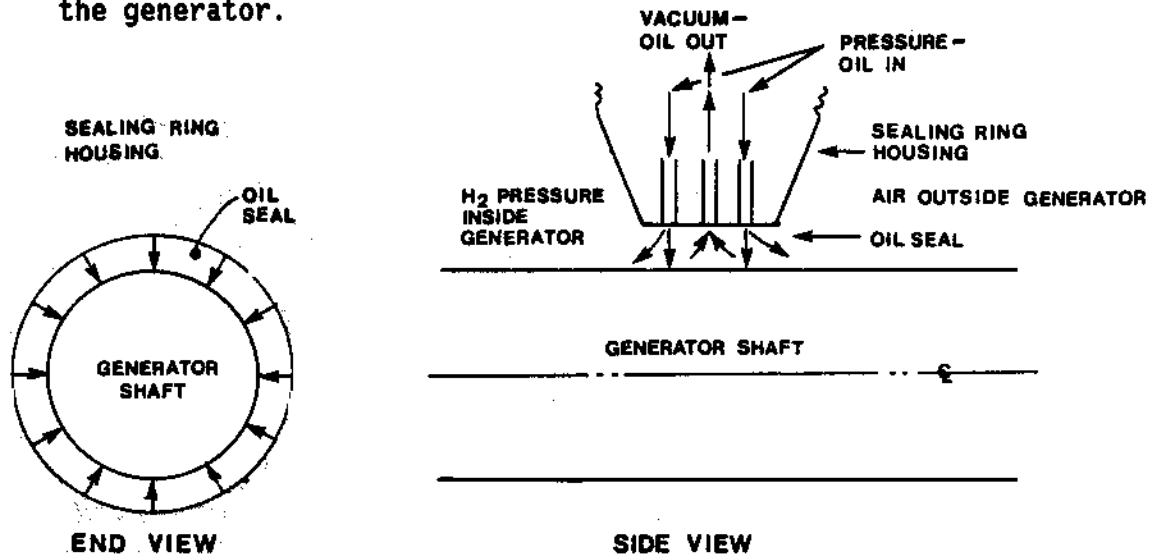

Figure 4: A Typical, Simplified, Radial Hydrogen Oil Seal

4.0 GENERATOR HYDROGEN SEAL OIL SYSTEM

4.1 Purpose of the Generator Hydrogen Seal Oil System

The purpose of the generator hydrogen seal oil system is to clean, lubricate and cool the hydrogen seal face while providing the required sealing pressure.

4.2 Operational Requirements of the Generator Hydrogen Seal Oil System

It was indicated in Section 3.3 above that the seal oil flows through the seal to the seal face in order to cool and lubricate the seal face and provide the dynamic, hydrogen seal. Six operational requirements of the seal oil system are:

- (i) To provide sufficient oil flow to keep the seal face lubricated and cooled under all operating conditions.
- (ii) To maintain the oil at a predetermined differential pressure, greater than the hydrogen pressure in the generator, and thereby provide the actual hydrogen seal.

- (iii) To maintain the seal oil at the correct operating temperature under all operating conditions.
- (iv) To provide filtration to remove any particulates which could score the soft metal seal face.
- (v) To remove entrained hydrogen from the oil and vent the hydrogen safely to atmosphere.
- (vi) To provide an emergency oil supply in the event of failure of the main seal oil pumps.

4.3 A Typical Generator Hydrogen Seal Oil System

Figure 5, is a simplified diagram of a typical generator hydrogen seal oil system, showing the system components and the direction of the oil flow. The following is a brief description of the function of the major components:

4.3.1 Oil From Main Turbine Oil System

The seal oil is normally supplied from the main turbine lubricating oil system via a turbine shaft driven pump and pressure relief valve (PRV).

4.3.2 AC Seal Oil Pump

If the turbine shaft driven pump is unable to provide suitable seal oil pressure, a Class IV ac pump is used. The combination of shaft driven and/or ac pumps will vary from station to station.

4.3.3 DC Seal Oil Pump

If the main oil pump and ac oil pump are unable to provide suitable seal oil pressure, a Class I dc pump starts automatically. The filters and coolers are bypassed by the oil which flows from the dc seal oil pump to the seals. Some stations will have alternate backup/emergency oil supplies.

Note that the provision of redundant oil pumps and different pump motor power supplies helps to ensure that the hydrogen seal will be maintained and kept properly cooled and lubricated whenever the generator is in any operating state other than shutdown and air filled.

4.3.4 Pressure Controls and Alarms

Various pressure controls and alarms are provided to maintain the seal oil pressure at a fixed differential above the hydrogen pressure, to provide alarms for low oil pressure and to start pumps when required.

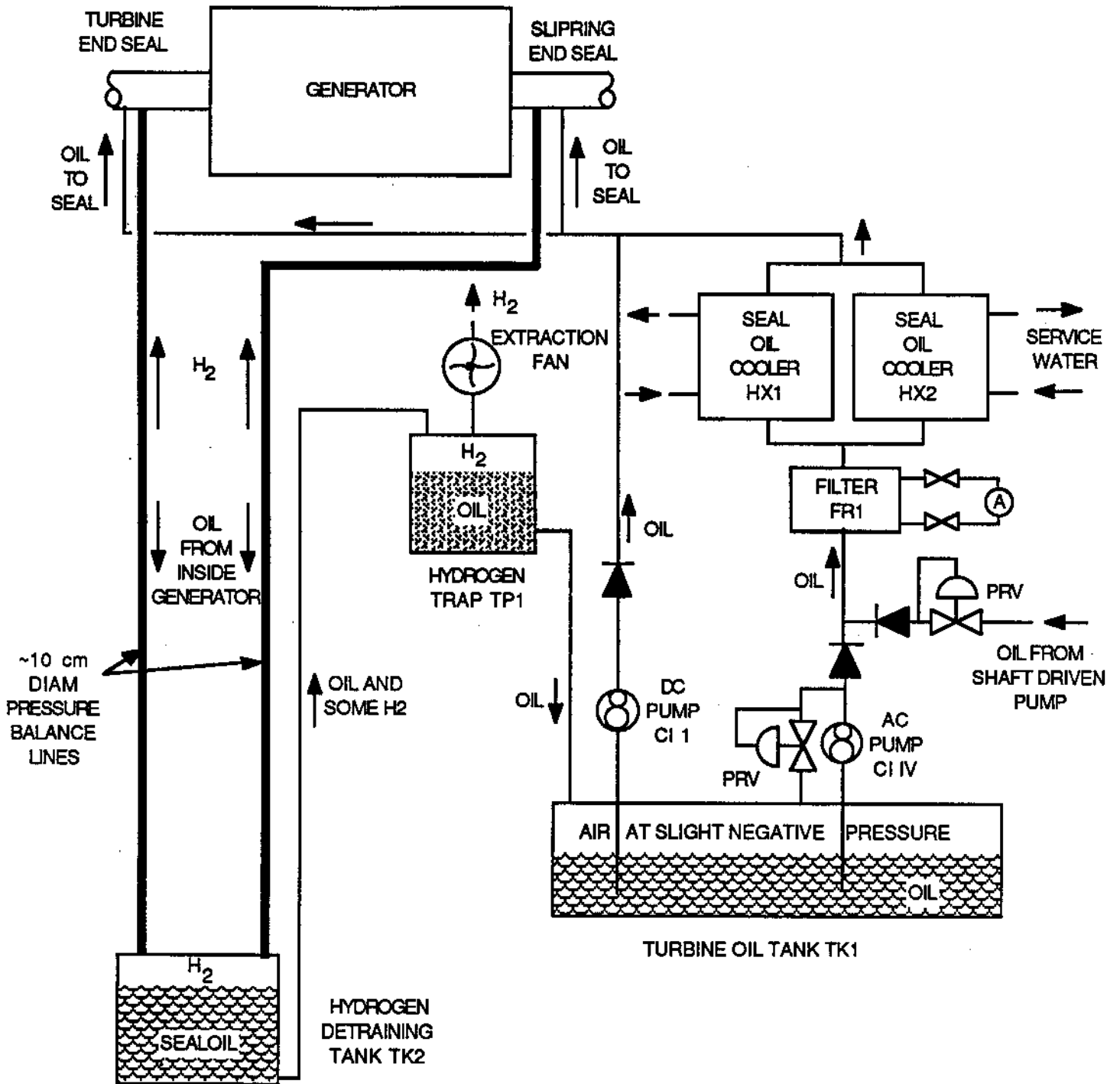

Figure 5: Simplified Circuit of the Seal Oil System

4.3.5 Seal Oil Filters and Coolers

The seal oil filters are provided to remove any particulates from the oil before it is supplied to the generator hydrogen seals. The filters are instrumented for high ΔP across the input/output lines. The coolers cool the oil before it flows through the seals, thereby maintaining the soft-metal seal faces within their operating temperature range. The seal oil temperature is controlled via the seal oil coolers which are supplied by manually operated service water valves. Thermocouples embedded in the seal face are used to monitor for high seal face temperatures.

4.3.6 Detraining Tank

The major portion of the seal oil flow drains to the bearing sumps and then to the turbine and seal oil tank.

The small amount of seal oil that flows inwards to the hydrogen side then drains down to the hydrogen detraining tank via a sight glass and ≈ 10 cm diameter pressure balance line. In the detraining tank, the entrained hydrogen separates from the oil. The oil is forced up to the hydrogen trap by the generator hydrogen pressure.

4.3.7 Hydrogen Trap and Extraction Fan

Any hydrogen remaining in the oil is removed in the hydrogen trap and is safely vented to atmosphere by an extraction fan. The seal oil flows by gravity down to the turbine and seal oil tank.

4.3.8 Turbine and Seal Oil Tank

This large tank provides a sump for all of the oil used in the turbine lubricating and seal oil systems.

5.0 GENERATOR HYDROGEN COOLING SYSTEM

5.1 Purpose of the Generator Hydrogen Cooling System

The purpose of the generator hydrogen cooling system is to maintain the generator rotor and the stator iron within their proper operating temperature ranges under all operating conditions.

5.2 Operational Requirements of the Generator Hydrogen Cooling System

As was indicated in PI30.23-1 heat is removed from the generator rotor and the stator iron by continuously passing hydrogen gas through them. Seven operational requirements of the generator hydrogen cooling system are:

- (a) To continuously recirculate the hydrogen gas within the generator.
- (b) To cool the hydrogen to the required temperature.
- (c) To dry the hydrogen to the required dewpoint.
- (d) To maintain the correct hydrogen gas pressure in the generator by providing make-up hydrogen to compensate for leaks.
- (e) To provide an alarm for liquid oil or water within the generator cavity.
- (f) To monitor the hydrogen gas purity.
- (g) To provide CO₂, Air and H₂, for purging and charging the generator.

5.3 A Typical Generator Hydrogen Cooling System

Figure 6 is a simplified diagram of a typical, large generator showing the directions of the hydrogen flow within the generator. The following are brief explanations of the functions of the major components of the generator hydrogen cooling system.

5.3.1 Centrifugal Fans, Hydrogen Flow Paths

The centrifugal fans located at each end of the rotor draw hydrogen from the "air gap" between the rotor and stator and blow it through the coolers located within the generator yoke. From the coolers the hydrogen is directed to both the stator iron and to the rotor. The cool hydrogen passes through ducts in the stator iron and enters the air gap from the centre portion of the stator iron. The cooled hydrogen is also directed to the rotor ends by sheet metal shrouding and enters the end bells, percolates through and along the rotor windings and emerges into the air gap along the centre portion of the rotor.

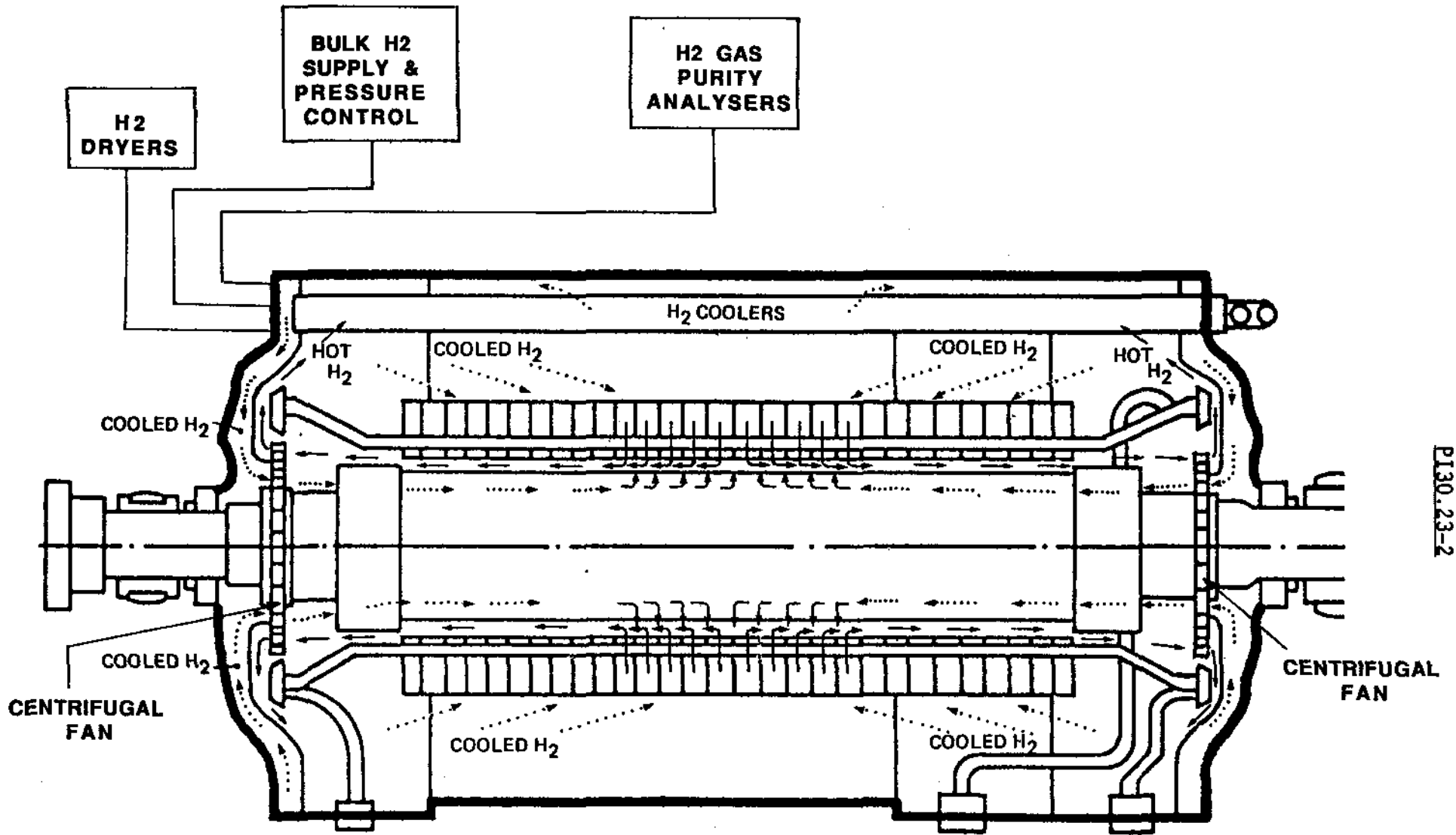

Figure 6: A Typical Generator Hydrogen Cooling System

5.3.2 Hydrogen Coolers

The hydrogen coolers are long, finned, U-tube units mounted axially in compartments located in the generator yoke. (Also, see Figures 5 and 6 of PI30.23-1). Service water is circulated through the cooler tubes. The hot hydrogen passes over the finned tubes, loses its heat to the service water and then flows on to cool the stator iron and rotor conductors. The hydrogen temperature is controlled by automatically regulating the flow of service water to the coolers, using RTDs within the stator to measure the hydrogen temperature.

5.3.3 Gas Supplies - H₂, CO₂ and Air

Hydrogen from a bulk storage system is fed to the generator via a pressure regulating valve. The H₂ pressure within the generator is held relatively constant by the hydrogen make-up system.

CO₂ from portable bottles is used to purge hydrogen or air from the generator when required. The CO₂ is then displaced by clean, dry air if the generator is to be opened for maintenance.

5.3.4 Hydrogen Dryer

Typically, the hydrogen dryer will be a twin tower type using beds of activated alumina. Cycle times are adjusted to suit the drying load. Refrigeration type driers are used in some stations.

5.3.5 Hydrogen Gas Analyzer

The gas analyzer unit analyzes the H₂ purity when the generator is at operating speed. A low purity alarm is provided. A portable gas analyzer is used when charging and discharging the generator.

The primary significance of hydrogen purity is the requirement to avoid an explosive H₂/Air mixture, ie, H₂ content must be above 96% or below 5%.

6.0 PRECAUTIONS

There are six major precautions related to the generator cooling systems discussed in this lesson. This section is a review and consolidation of the previous material.

(a) Stator Cooling Water Conductivity

Since the large generators used in NGS operate at 18 000 volts ac or above, it is absolutely essential that the stator cooling water conductivity be kept low enough to provide adequate electrical insulation. This is both a personnel and an equipment concern.

(b) Hydrogen/Air Concentrations

The hydrogen/air concentration must be kept outside the explosion range to avoid serious damage to equipment and possible fire injury to personnel.

(c) Hydrogen to Seal Oil Differential Pressure

The seal oil pressure must be greater than the hydrogen pressure to prevent leakage of hydrogen from the generator. Again the concern is for personnel and hardware.

(d) Hydrogen to Stator Water Differential Pressure

To prevent leakage of liquid water from the stator system into the hydrogen, the hydrogen pressure must be greater than the stator cooling water pressure. Liquid water inside the generator represents a physical impact hazard to the spinning rotor and is also potentially an electrical short circuit hazard if it picks up impurities.

(e) Hydrogen Dryness

To prevent condensation and possible ground faults within the generator, the hydrogen gas which is circulating in the generator must be kept dry enough to always be above the dewpoint. To assist in the prevention of condensation, the stator cooling water temperature must always be above the hydrogen temperature.

(f) Drains

Any leakage of liquid, oil or water into the generator can cause severe physical damage. The drains from the bottom of the generator must be operational.

7.0 HYDROGEN GAS AS A COOLANT

Five advantages relating to the choice of hydrogen rather than air as a cooling medium in large NGS generators are discussed very briefly below:

(a) Density

Hydrogen gas has a lower density than air, so windage losses are less and less fan power is required for circulation. This low density permits higher working pressures thereby increasing heat removal capability.

(b) Specific Heat Capacity

Hydrogen has approximately seven times the specific heat capacity of air.

(c) Mass Flow

The cooling capability and, hence, the output of the machine is significantly increased, without a corresponding increase in windage losses, by pressurizing the hydrogen.

(d) Insulation Life

When a machine is hermetically sealed and kept free of oxygen, the interior is less subject to contaminants. This prolongs insulation life.

(e) Fire

A fire hazard inside the generator is eliminated because the pure hydrogen atmosphere inside the generator will not support combustion.

Disadvantages relating to the use of hydrogen as a cooling medium are:

(a) Explosion Hazard

Hydrogen in air is explosive, between 5% and 96% concentration. The hydrogen/air ratio must not be permitted to reach the explosion range either inside or outside the generator.

Systems must be provided to achieve this criteria.

(b) Hydrogen Seals/Supply

The provision and maintenance of rotating seals increases both design complexity and maintenance requirements.

A bulk hydrogen supply is required to fill and pressurize the machine with clean, dry hydrogen.

ASSIGNMENT

- (1) With respect to the generator stator cooling system shown in the attached diagram:
 - (a) State its purpose.
 - (b) List and briefly explain five operational requirements of the stator cooling system.
 - (c) Identify the numbered components.
 - (d) Briefly explain the function of each component identified in (c).
 - (e) Using arrows, identify the flow direction of the stator cooling water.

- (2) With respect to the generator hydrogen seal shown in the attached diagram:
 - (a) State its purpose.
 - (b) State three operational requirements of the seal.
 - (c) Briefly explain its operation.
 - (d) State the flow directions of the seal oil.

- (3) With respect to the generator hydrogen seal oil system shown in the attached diagram:
 - (a) State its purpose.
 - (b) List and briefly explain six operational requirements of the system.
 - (c) Identify the numbered components.
 - (d) Briefly explain the function of each component identified in (c).

- (4) With respect to the generator hydrogen cooling system shown in the attached diagram:
 - (a) State its purpose.
 - (b) List and briefly explain seven operational requirements of the system.
 - (c) Identify the numbered components.
 - (d) Briefly explain the function of each component identified in (c).
 - (e) Using arrows, identify the flow paths of the hydrogen gas.
- (5) List and briefly explain six precautions related to the generator cooling systems used with the large turbo-generators in NGS.
- (6) List and briefly describe five advantages and two disadvantages related to the use of hydrogen as a coolant in large generators in NGS.

QUESTION #1

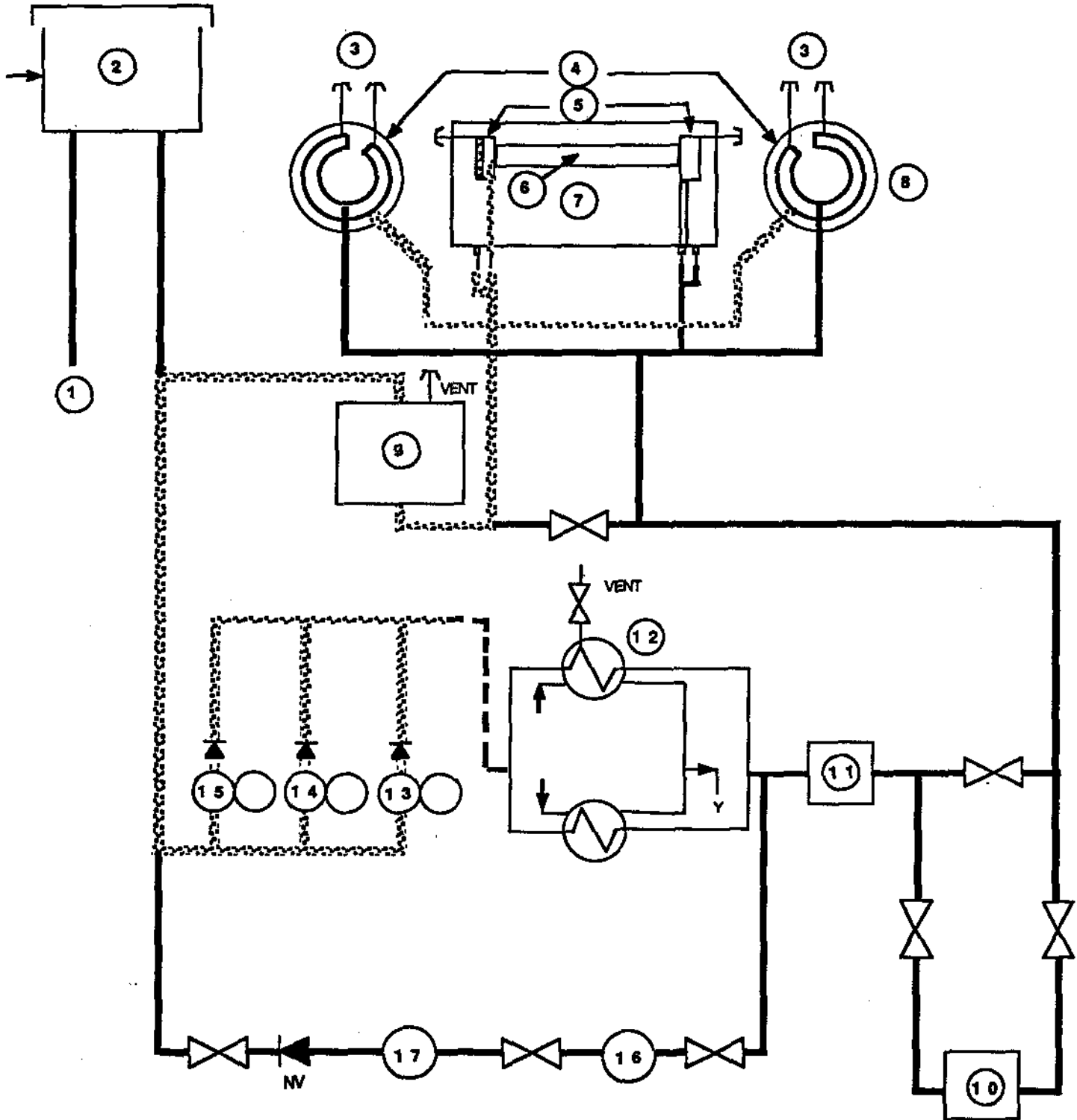

Simplified Diagram of a Typical Stator Cooling System

QUESTION #2

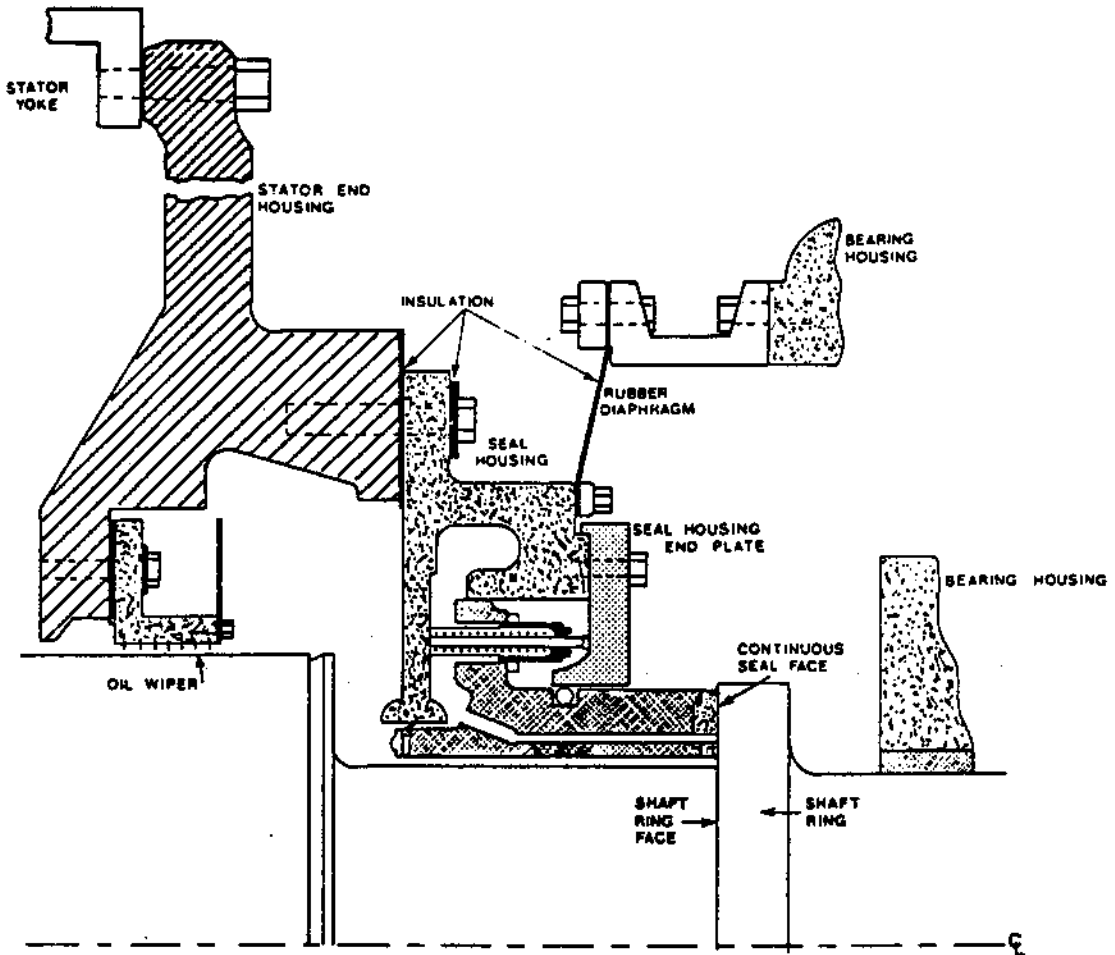

Section of a Generator Hydrogen Seal

Section of a Generator Hydrogen Seal

QUESTION #3

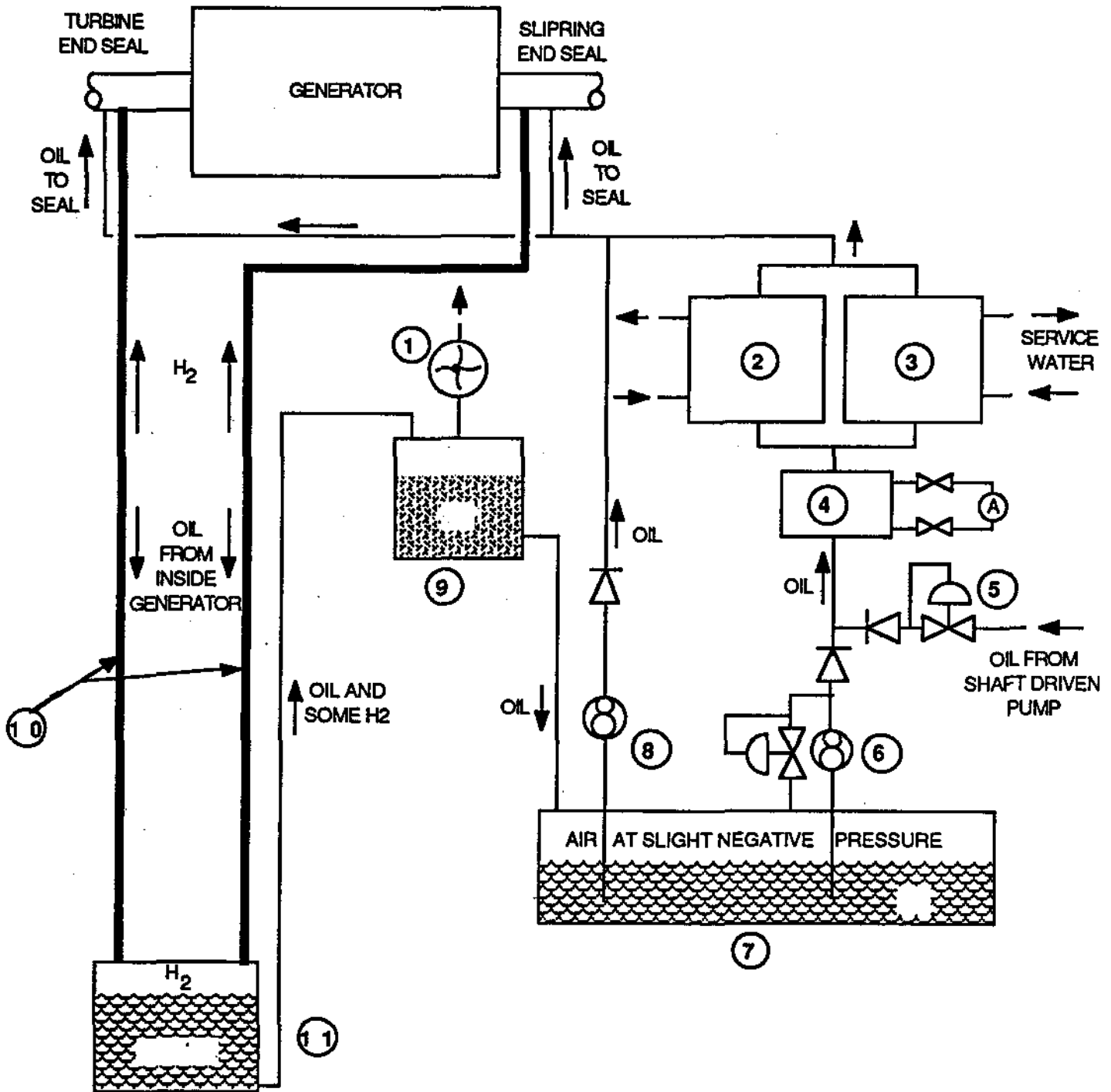

Simplified Circuit of a Typical Seal Oil System

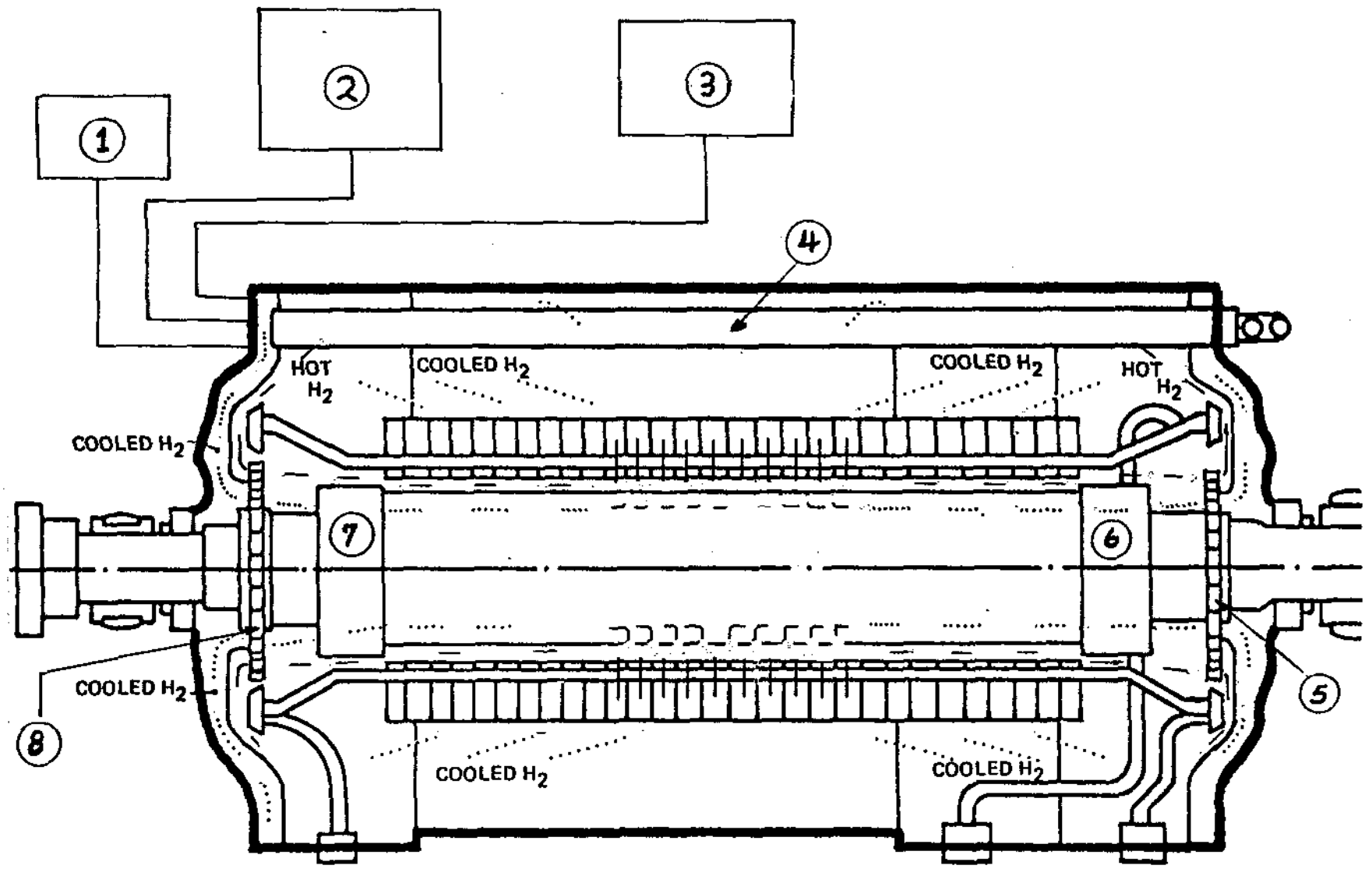

A Typical Generator Hydrogen Cooling System