

**Nuclear Training Course PI27  
TIMS Ref. PI2007**

# **Nuclear Theory**

This course was originally developed for  
the use of Ontario Hydro employees.  
Reproduced on the CANTEACH web  
site with permission

**NUCLEAR TRAINING DEPARTMENT**

**COURSE PI 27**

**NUCLEAR THEORY**

**FOR ONTARIO HYDRO USE ONLY**

**NUCLEAR TRAINING COURSE**

**COURSE PI 27**

**NUCLEAR THEORY**

**INDEX**

PI 27.00-0	Objectives
427.00-2	Radioactivity
227.00-1	Nuclear Structure
227.00-2	Neutron Reactions
227.00-3	Neutron Cross Sections, Neutron Density and Neutron Flux
227.00-4	Thermal Reactors
227.00-5	Neutron Multiplication Constant and Reactivity
227.00-6	Neutron Flux Distribution
227.00-7	Effect of Fuel Burnup
227.00-8	Changes In Reactor Power With Time
227.00-9	Source Neutron Effects
227.00-10	Power and Power Measurement
227.00-11	Fission Product Poisoning
227.00-12	Reactivity Effects Due To Temperature Changes
227.00-13	Reactivity Control
227.00-14	The Approach To Critical

**PI 27.00-0**

**Nuclear Theory - Course PI 27**

**OBJECTIVES**

---

At the conclusion of this course the trainee will be able to:

**427.00-2 Radioactivity**

1. For  $\alpha$ ,  $\beta$ ,  $\gamma$  decays
  - (a) Write typical equations for each.
  - (b) List the physical properties.
  - (c) Discuss interactions with materials.
2. Know how to shield against alphas and betas.
3. Know how to shield against  $\gamma$  rays and be able to calculate  $\gamma$  ray shielding of 1/2 value layers.

**227.00-1 Nuclear Structure**

1. Explain the concept of binding energy.
2. Discuss the stability of nuclei in terms of their neutron-proton ratio.
3. From a plot of n against p say what emission a given nuclide is likely to undergo.
4. Be able to follow a decay chain from a radioactive nuclide until a stable nuclide is reached.
5. Define the unit of activity, the Becquerel.
6. State the basic law governing radioactive decay.
7. State the relationship between decay constant ( $\lambda$ ) and half life ( $t_{1/2}$ ).

**227.00-2 Neutron Reactions**

1. Differentiate between elastic and inelastic collisions.
2. Explain the importance of elastic collisions to the operation of CANDU reactors.

PI 27.00-0

3. State the name of the four types of inelastic collisions giving an example of each ( $Z^A A$ ) type example is acceptable).
4. Differentiate between spontaneous and induced fission.
5. Explain a self sustaining chain reaction.
6. Write the equations for the formation of  ${}_{94}\text{Pu}^{239}$  in our reactors.
7. Define:
  - (a) Prompt Neutrons
  - (b) Delayed Neutrons
  - (c) Delayed Neutron Precursors
  - (d)  $\beta$  - Delayed Neutron fraction
  - (e)  $\nu$  - Neutrons Emitted per Fission
  - (f) Photoneutron
  - (g) Fast neutrons
  - (h) Thermal neutrons
8. Give the distribution of energy released by the fission of U-235.

227.00-3 Neutron Cross Sections, Neutron Density and Neutron Flux

1. Define:
  - (a) Microscopic Neutron Cross Section and the units.
  - (b) Macroscopic Neutron Cross Section and the units.
  - (c) Neutron Density and the units.
  - (d) Neutron Flux and the units.
2. Relate  $\sigma_a$ ,  $\sigma_f$  and  $\sigma_{n,\gamma}$ .
3. Discuss how the microscopic cross sections of U-238 and U-235 vary with neutron energy.
4. Write reaction rates.
5. Be able to extract data from the chart of the nuclides.

227.00-4 Thermal Reactors

1. Discuss the properties of a moderator including the number of collisions required to thermalize a neutron, scattering cross section, and absorption cross section.
2. Define the moderating ratio.
3. Explain the practical significance of the fact that D<sub>2</sub>O, compared to H<sub>2</sub>O has a lower scattering cross section and requires more collisions to thermalize a neutron.
4. Discuss the effect of downgrading the moderator or heat transport fluid.
5. Define lattice pitch.
6. Explain what "over moderated" means and why Hydro's reactor are over moderated.
7. Explain why increasing or decreasing the lattice pitch from its optimum value causes reactivity to change.

227.00-5 Neutron Multiplication Constant and Reactivity

1. Define k both in words and in terms of the six factors.
2. State when the word definition is not valid.
3. Define and explain each of the six factors in k.
4. Sketch a neutron life cycle using the six factors.
6. Define:
  - (a) Critical
  - (b) Subcritical
  - (c) Supercritical
7. State and explain the significance of the four-factor formula for  $k_{\infty}$ .
8. Define and calculate values of reactivity and of reactivity worths.
9. Calculate values of the six factors given a neutron life cycle.

## PI 27.00-0

### 227.00-6 Neutron Flux Distribution

1. Discuss the functions of a reflector.
2. Discuss the effects of a reflector.
3. Explain why flux flattening is desirable.
4. Discuss the four methods of flux flattening used.
5. Sketch the flux shapes showing the effect of each of the flux flattening methods.
6. Discuss the effect of reactor size and shape on neutron leakage.

### 227.00-7 Effect of Fuel Burnup

1. State and explain the units used for fuel burnup.
2. Explain why the combined reactivity worth due to U-235 and Pu-239 initially increases then decreases with burnup.
3. Explain how and why each of the four factors of  $k_{\infty}$  changes with fuel burnup.
4. Explain how and why the delayed neutron fraction ( $\beta$ ) changes with fuel burnup.

### 227.00-8 Changes in Reactor Power with Time

1. Physically explain the effect of delayed neutrons on changes in reactor power.
2. Given the formula,  $P(t) = \frac{\beta}{\beta - \Delta k} P_0 e^{\frac{\lambda \Delta k t}{\beta - \Delta k}}$ , solve calculational type problems.
3. Explain the concept of the prompt jump.
4. Define prompt criticality and explain why it is undesirable. Explain its dependence upon fuel composition and fuel burnup.

### 227.00-9 Source Neutron Effects

1. State the sources of neutrons and their approximate magnitudes.

## PI 27.00-0

2. State and use the formula  $S_{\infty} = \frac{S_0}{1-k}$ .
3. Define and explain the significance of the subcritical multiplication factor.
4. Calculate k in a subcritical reactor given appropriate data.
5. State that, for a sub-critical reactor, the closer k is to one, the longer it takes for power to stabilize after a reactivity change.

### 227.00-10 Power and Power Measurement

1. Explain how thermal power is measured.
2. Explain why neutron power must be calibrated to thermal power.
3. Explain the reasons why neutron power is used for control and protection of the reactor.
4. State the relationship between reactor period and rate log N. (For engineers: Prove the relationship).
5. Make an accurate sketch of the rundown of neutron power after a trip justifying times and power levels used.
6. Discuss the rundown of thermal power after shutdown.

### 227.00-11 Fission Product Poisoning

1. Explain how xenon and iodine are produced in the reactor and how they are lost from the reactor.
2. Write the differential equations for the concentration of xenon and iodine and define each term.
3. State the magnitude of the production and loss terms for xenon at equilibrium in our larger reactors.
4. Define Xenon Load and Iodine Load.
5. Explain what Xenon Simulation is.
6. Sketch and explain the behaviour of xenon after a trip from full power.
7. State and explain the two conditions necessary for a Xenon Oscillation.



PI 27.00-0

8. Explain what a Xenon Oscillation is and how one may be started.
9. Explain why samarium growth after shutdown is not a problem.

227.00-12 Reactivity Effects Due to Temperature Changes

1. Explain why a negative fuel temperature coefficient of reactivity is desirable.
2. Give two undesirable effects of having a negative fuel coefficient.
3. Explain why the fuel temperature coefficient is more important than either the coolant or moderator temperature coefficient.
4. Explain why the fuel temperature coefficient is negative and why its value changes from fresh to equilibrium fuel.
5. Define the power coefficient and give a typical value.
6. Define the void coefficient.

227.00-13 Reactivity Control

1. List the various in-core reactivity worth changes, typical magnitudes of the changes, and the time period over which the changes occur.
2. Discuss general methods of reactivity control in terms of their effect on the six factors of  $k$ .
3. Given a specific method of reactivity control (eg, Moderator Level Control) discuss its advantages and disadvantages.
4. List and discuss the advantages and disadvantages of each of the presently used shutdown systems.

227.00-14 The Approach to Critical

1. Explain why the initial approach to criticality is potentially hazardous.
2. Explain how inverse count rate is used to predict the critical value of the controlling reactivity mechanism.

RADIOACTIVITY - SPONTANEOUS NUCLEAR PROCESSES

---

OBJECTIVES

At the conclusion of this lesson the trainee will be able to:

1. For  $\alpha$ ,  $\beta$  and  $\gamma$  decays
  - a) Write a typical equation for the production of each type of radiation.
  - b) List the physical properties of each type of radiation.
  - c) Discuss how each type of radiation interacts with matter.
2. State how to shield against alphas and betas.
3. State how to shield against  $\gamma$  rays and calculate  $\gamma$  ray shielding in terms of  $\frac{1}{2}$  value layers.

427.00-2



Beta Emissions

Beta particles are emitted by neutron-rich nuclides, i.e. a nuclide with too many neutrons. This is a typical example:

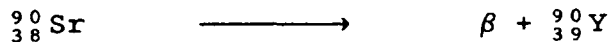

You may put the mass number and charge number onto the  $\beta$  symbol if desired, giving:

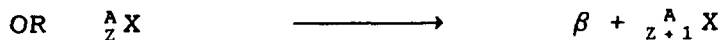
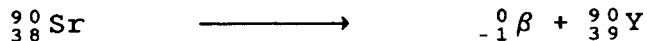

As noted from the above expressions the daughter nuclide from beta decay appears one position higher in the table of the elements. A neutron in the nucleus has changed into a proton so the atomic number goes up one.

The beta particle is a fast moving electron. It has the same mass as any other electron, 0.00054u, and it has the same charge, -1. The speeds of beta particles range from about 90 to 99% of the speed of light. They are very fast!

Gamma Emissions

After an alpha or beta emission the residual nucleus will usually be in an excited state. Excited states must not be confused with the concept of unstable nuclides. Both stable and unstable nuclides can be in an excited state. The mode of de-excitation could be by emission of a suitable particle ( $\alpha$ ,  $\beta$ , neutron, proton) but in most cases the de-excitation takes place by the emission of one or more gamma photons. The name photon is used to emphasize that gamma radiation has particle-like properties. A typical example is written:



The cobalt-60 emits a beta leaving the daughter nickel-60 nucleus in an excited state (indicated by the asterisk). Almost immediately the excited nickel-60 emits  $\gamma$ -rays until it is de-excited. The duration of the excited state is very short, usually less than  $10^{-9}$ s so we usually write the beta and gamma decays as though they are a single event.

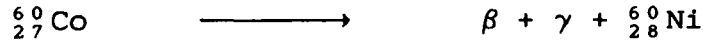

The generalized gamma decay can be written:



As you can see there is no change in Z or A because the gamma ray has no charge and no mass so it cannot affect the charge and mass of the nuclide.

Gamma rays are electro-magnetic radiations like light rays, radio waves and x-rays. A gamma photon has more energy than most x-ray photons which in turn have more energy than ultra violet photons and so on, down to the longest wave length radio waves. Figure 2.1 shows the electromagnetic spectrum. Note that long waves imply low frequencies, low photon energies, and wave like properties. High energy  $\gamma$ -rays are more particle-like in their interactions. The gamma ray speed is the same as that of light in a vacuum.

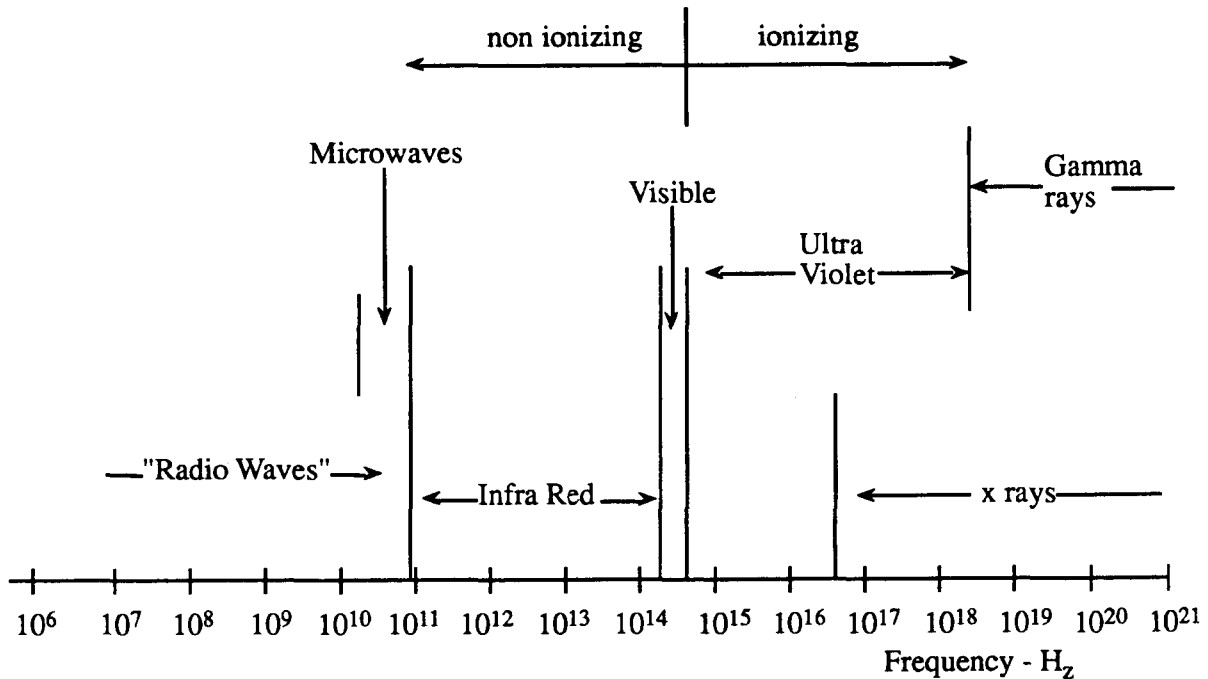

Figure 2.1: Electro Magnetic Spectrum

INTERACTION OF PARTICLES OR RAYS WITH MATTER

Alpha and beta particles are classed as ionizing particles. This is because they carry electric charge which causes the atoms they approach to separate into ions. Each separation creates an ion-pair.

Ionization by Alpha Particles

Alpha particles with their charge of +2 and their mass of 4u create intense ionization. In dry air the alpha causes about 50 000 ion-pairs per centimeter of its path, giving up about 33 eV per pair produced. A 4 MeV alpha travels about 2.5 cm before all its energy is used up. It slows down and stops and becomes a normal helium atom by adopting two electrons from neighbouring atoms.

In liquids or solids the ion-pairs per centimeter is much greater and the distance travelled by the alpha is much less. In general the range (straight line distance) of alpha particles in solid materials is less than 0.1 mm (about the thickness of a sheet of paper).

Ionization by Beta Particles

Beta particles have a charge of -1, a mass of 0.0005u and are travelling very fast (90-99%*c*). They cause less intense ionization than alpha particles, typically 100 - 300 ion-pairs per centimeter of path in dry air. Because of their small mass the beta particles are deflected easily and do not travel in a straight line. In air their total length of path would be typically 20 m. Beta particles are more penetrating than alphas and will penetrate a sheet of paper. Generally a mm or so of a dense material will be sufficient to stop them.

Gamma Ray Interaction with Atoms

Gamma rays behave differently from alpha and beta particles. First, they have no charge and no mass. Secondly, they do not lose their energies in small, scattered amounts, but give it away in larger chunks when they undergo a reaction. Three of the possible reactions between gamma rays and atoms are described below.

1. The photoelectric effect.

This gamma ray interaction can take place for gamma rays of low energy. An incident gamma ray reacts with an electron in an atomic orbit. The gamma photon gives all of its energy to an orbiting electron. The gamma ray ceases to exist and the electron is ejected from the atom and behaves like a beta particle. In many materials, the photoelectric effect is not important for photon energies above 0.1 MeV.

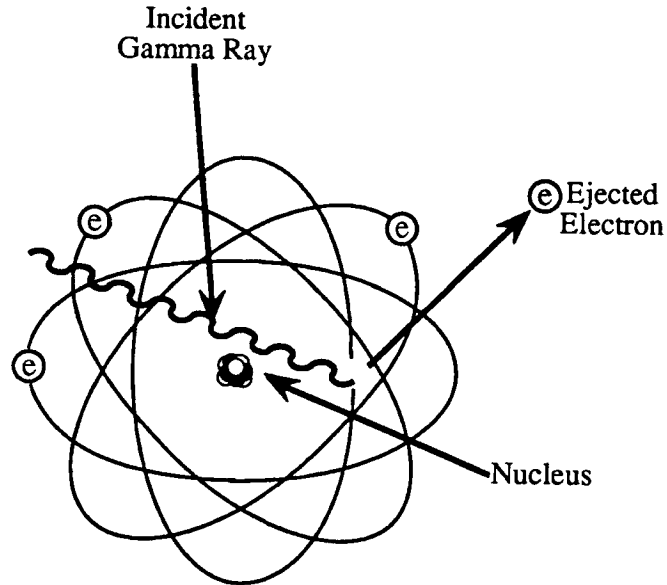

Figure 2.2: Photo Electric Effect

## 2. The Compton Effect

This gamma ray interaction occurs mainly for gamma photons with energies from about 0.1 to 10 MeV. The incident gamma ray is "scattered" by hitting an electron. The electron in turn is given some of the gamma ray energy and ejected from the atom. This electron is usually more energetic than the photoelectron and will cause ionization exactly like a beta particle.

The scattered gamma ray is really a different gamma ray as the original photon is absorbed and a new one emitted at a lower energy.

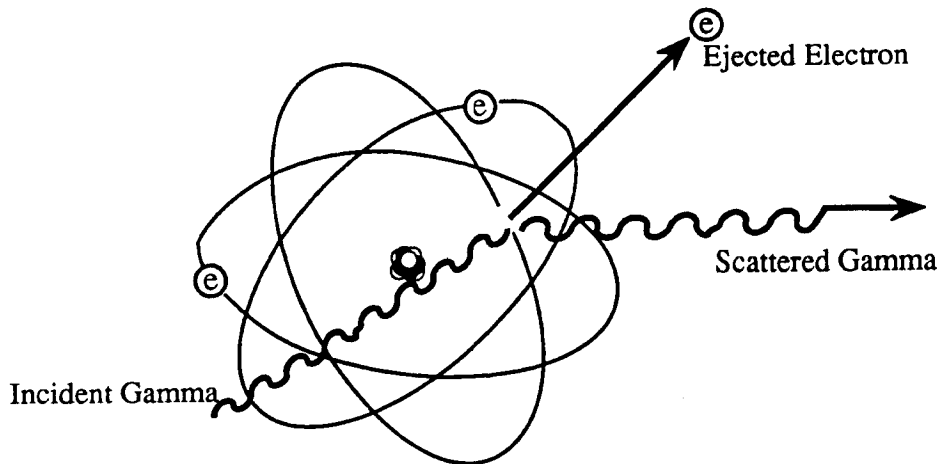

Figure 2.3: Compton Effect



### 3. Pair Production

This gamma ray interaction always occurs near an atomic nucleus which recoils. The gamma ray gives its energy to the creation of an electron-positron pair. (A positron is a positively charged electron!) The minimum gamma photon energy that can do this is 1.02 MeV (the energy equivalent of 2 electron masses). The process most often happens at higher energies.

The positive and negative electrons created both cause ionization but their fates differ. The positron will meet with another atomic electron and they will "mutually annihilate". Both cease to exist but 2 gamma rays of 0.511 MeV each are created. These gammas will go on and cause one of the other possible gamma ray interactions. The electron will eventually settle down with some accommodating atom and become a normal atomic electron.

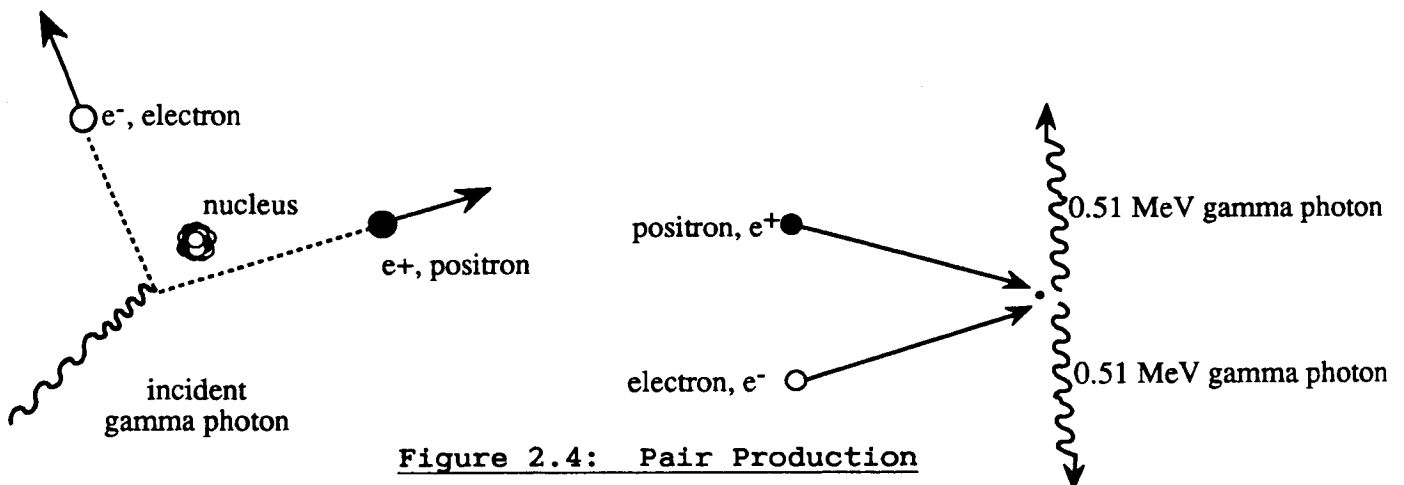

Figure 2.4: Pair Production

#### Direct and Indirect Ionization

Alphas and betas cause direct ionization. Each ion-pair created takes a small amount of energy and therefore slows the alpha or beta a little bit. Eventually the particle will be stopped. Alphas of a given energy would all travel the same straight line distance (range) in a given material. Similarly betas of a given energy would all have about the same range in a given material. By contrast the gamma rays cannot be assigned a range as they may interact immediately or travel a very long distance between interactions. The gamma ray energy is transferred in large chunks and is deposited in the material by indirect (i.e. secondary) ionizations near each of the interactions.

SHIELDING

It is easy to shield against alphas or betas, we simply need material of thickness equal to or greater than their range.

Shielding against gamma rays is not so easy. No matter how thick the shielding some of the gamma rays can still penetrate. For any particular energy of gammas we can always find the amount of material that will reduce the intensity to half. We call this the half value layer (HVL). Two half value layers would reduce the intensity to  $\frac{1}{4}$  of the original.

As an example, for gamma rays from fission products about 15 cm of water is a half value layer. In the irradiated fuel bays, water is maintained at least 4.5 m (30 HVL's) depth above the fuel. That means that the  $\gamma$  ray intensity reaching the surface of the bay will be reduced by a factor of  $2^{30}$ , that is, it has been halved 30 times. In round numbers that is a reduction of  $10^{-9}$  or one billionth of the original intensity. (You should check these numbers on your calculator.)

Gamma rays are shielded most effectively using materials made from heavy nuclei. Lead is often used where there is very little room for shielding. Where lighter materials (e.g. concrete or water) are used, greater thicknesses are needed.

Type of Radiation	Approximate Mass (AMU)	Charge	Energy Range (MeV)	Remarks
$\alpha$	4	+2	4 to 8	Very short range, highly ionizing
$\beta$	0.0005	-1	0.5 to 3.5	Short Range
$\gamma$	0	0	Up to 10 (most below 3)	Long Range

Table 2.1

427.00-2

ASSIGNMENT

1. Using  ${}^A_ZX$  notation, write equations for Alpha, Beta and Gamma decay.
2. Briefly explain how Alpha, Beta, and Gamma deposit their energy in matter.
3. List the masses and charges for  $\alpha$  and  $\beta$  particles.
4. What is ionization?
5. Why is it said that  $\gamma$  rays do not cause direct ionization?
6. Describe methods used to shield against  $\alpha$  or  $\beta$  particles.
7. What type of material makes good gamma ray shielding?
8. For a material of half value thickness of 6 cm, shielding 1 MeV gamma rays, calculate the thickness needed to reduce the intensity by 1 000.

A. Broughton

## Nuclear Theory - Course 227

## NUCLEAR STRUCTURE

The Nucleus, Nuclear Particles

The atomic nucleus consists of  $Z$  protons and  $N$  neutrons, where  $Z$  and  $N$  are the *atomic number* and *neutron number* respectively. The total number of *nucleons* in the nucleus, that is, neutrons and protons, is equal to  $Z + N = A$ , where  $A$  is the *atomic mass number*.

A nuclear species with a given  $Z$  and a given  $A$  is called a *nuclide*. To distinguish a particular nuclide it is written in the form  ${}_Z^A X$  where  $X$  is the chemical symbol for the element. Nuclides with the same  $Z$  but different  $A$  are called *isotopes*. Every element has a number of isotopes - most have both stable and unstable - some have only unstable which range from 3 (hydrogen) to 26 (tin), with an average of about 10 isotopes per element.

The mass of the proton is  $1.67252 \times 10^{-27}$  kg. It carries a positive charge of  $1.60210 \times 10^{-19}$  coulombs (C), equal in magnitude to the negative charge of the electron, and it is a stable particle.

The mass of the neutron is marginally greater than that of the proton, namely  $1.67482 \times 10^{-27}$  kg, and it is electrically neutral. The neutron is not stable unless it is bound in a nucleus. A free neutron decays to a proton with the emission of a  $\beta^-$  particle and an antineutrino, a process which has a half-life of 12 minutes. You will see later in this course that the average lifetime of neutrons in a reactor before they are absorbed or leak from the system is no greater than a millisecond. The instability of the neutron is therefore of no consequence in reactor theory.

Nuclear Masses

The mass of atoms are conveniently expressed in *unified mass units*, or u. The actual mass of a nucleus is measured on the *unified mass scale*, such that the mass of the  $C^{12}$  atom is precisely 12 u, and hence  $1 \text{ u} = 1.660438 \times 10^{-27}$  kg.

The atomic mass of a nuclide should be distinguished from the chemical atomic weight which is the average weight of a large number of atoms of a given element. It is not quite the same as the mass of an individual atom unless the element contains a single isotope. Furthermore, you should note that the atomic weight unit on the *chemical scale* is defined as one-sixteenth of the average weight of an oxygen atom in a natural

mixture of stable oxygen isotopes (0.204%  $O^{18}$ , 0.037%  $O^{17}$  and the rest  $O^{16}$ ). In many calculations this slight distinction (about 3 ppm) is insignificant and the atomic mass, denoted by  $A$ , is used rather loosely.

### Equivalence of Mass and Energy

Einstein showed that mass and energy are equivalent. The relationship between mass and energy changes may be written:

$$\Delta E = \Delta mc^2$$

where  $\Delta E$  is the energy change expressed in joules,  $\Delta m$  is the accompanying change in mass given in kilograms and  $c$  is the velocity of light, equal to  $3 \times 10^8$  meters per second.

A convenient and very common unit of energy in nuclear physics is the *electron volt* (abbreviated *eV*). It is the energy gained by an electron in being accelerated through a potential difference of 1 volt.

$$1 \text{ eV} = 1.6021 \times 10^{-19} \text{ joule}$$

$$1 \text{ keV} = 10^3 \text{ eV}$$

$$1 \text{ MeV} = 10^6 \text{ eV}$$

Using Einstein's formula it can readily be shown that converting 1 amu of mass yields  $\sim 931$  MeV of energy.

### Binding Energy

The mass of the proton is 1.00728 u, and the mass of the neutron is 1.00867 u. The actual mass of a nuclide is not equal to the total mass of its individual nucleons, the difference being called the *mass defect*. This mass defect is a consequence of the equivalence of mass and energy and arises from the *binding energy* of the nuclide. This is the energy required to split the nuclide into its individual component nucleons. Experimental results (Figure 1) show that except for a few light nuclides, the binding energy per nucleon in the nucleus, increases rapidly as the size of the nucleus increases up to about  $A = 60$ , but for greater values it decreases again gradually. This means that nuclei of intermediate mass are more strongly bound than the light and the heavy nuclei. Thus energy may be released by combining two light nuclei (*fusion*);

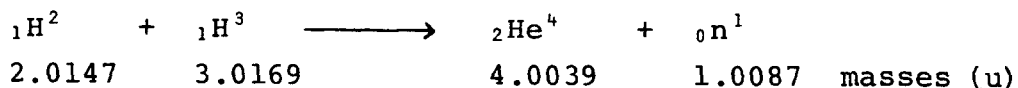

Here 0.019 u is converted to 17.7 MeV.

Or by splitting a heavy nucleus into two nuclei of intermediate mass (fission);

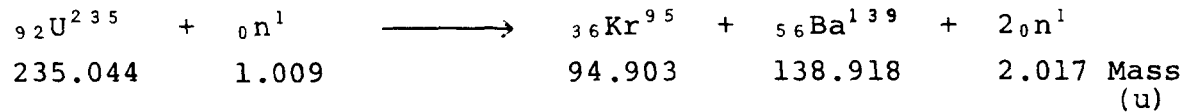

Here 0.215 u is converted to 200.2 MeV.

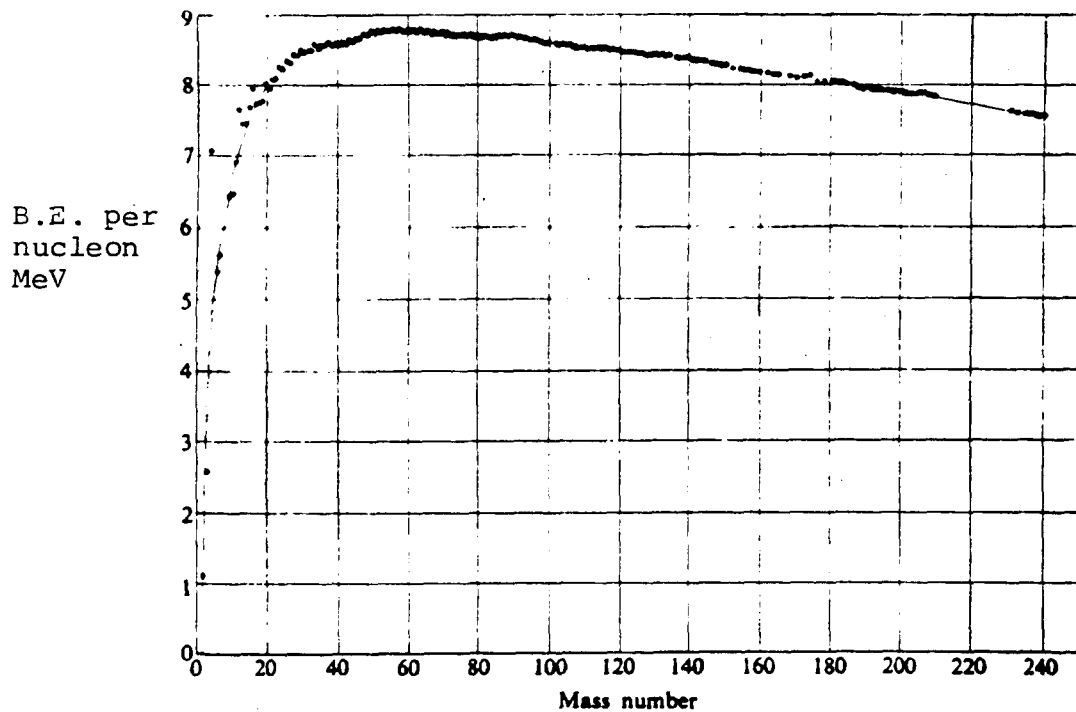

Figure 1

Binding Energy vs Mass Number

### Nuclear Forces

Between two electric charges of the same sign there is a repulsive force which is called a *Coulomb force*. Since nuclei may contain a large number of positive protons each repelling the other due to Coulomb forces it is clear that there must be other forces present which are attractive. These are short range *nuclear forces*. They act between all adjacent nucleons, whether n-p, n-n, or p-p, and drop off rapidly on separation of the nucleons.

The lighter stable nuclei contain roughly equal numbers of neutrons and protons (eg,  ${}^6\text{C}^{12}$ ,  ${}^8\text{O}^{16}$ ,  ${}^9\text{F}^{19}$ ,  ${}^{11}\text{Na}^{23}$ ). As the number of protons in the nucleus increases, the long range Coulomb forces build up more rapidly than the nuclear forces which only have short range. Therefore, in order for heavier nuclei to remain intact more neutrons are required to supply binding forces between all particles to overcome the disruptive Coulomb forces. As a result, the n/p ratio required for stability gradually increases from one in light nuclei to about one and a half in heavier nuclei. This increase in the n/p ratio for stable nuclei is shown in Figure 2.

It should be noted that this is a very simple model and it cannot explain all the facts of nuclear stability or decay.

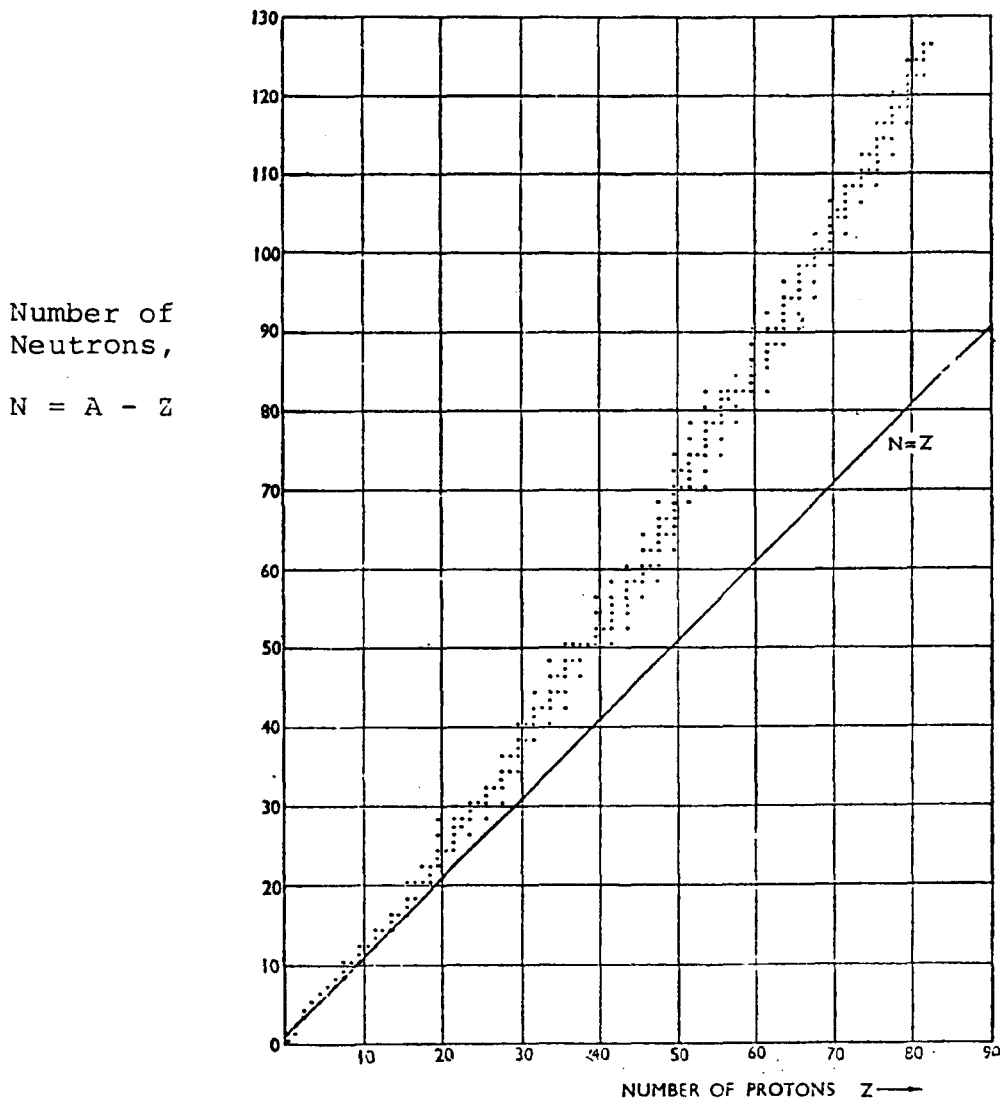

Figure 2

Neutron/Proton Ratio



For reasons of no particular significance to us, there is a limit to the number of excess neutrons a nucleus can live with, and as a result the heavy nuclei are all unstable and there are no naturally occurring elements having a value of  $A$  greater than 238.

### Nuclear Energy Levels

A nucleus is said to be in its *ground state* when the nucleons are arranged in such a way that the potential energy is a minimum. If it is not in its ground state it is said to be in an *excited state* and the excess of energy is called *excitation energy*. The potential energy does not take on a continuous range of values, but has discrete values which are termed *energy levels*. For heavy nuclei these energy levels have a minimum separation of about 0.1 MeV, for light nuclei this separation is much greater.

### Radioactivity

All the naturally occurring nuclides heavier than lead ( $Z = 82$ ) and a few lighter nuclides are unstable and are *naturally radioactive*. They decay by emitting either an *alpha particle* (helium nucleus) or a *beta particle* (fast electron). In most cases the resulting nucleus, or *daughter*, is produced in an excited state. It then decays to its ground state by the emission of one or more *gamma photons*. Usually, but not always, this occurs instantaneously, ie, within  $10^{-14}$  seconds of the formation of the daughter.

Radioactivity is governed by only one fundamental law, namely that the probability of a radionuclide decaying per unit time is constant and independent of external conditions. This constant is called the *decay constant* and is denoted by  $\lambda$ .

Thus the rate of change of single kind or radionuclide is:

$$\frac{dN}{dt} = -\lambda N$$

where:  $N$  = Number Density in ATOMS/cm<sup>3</sup>  
 $\lambda$  = decay constant in 1/s

The solution to this simple differential equation is:

$$N(t) = N_0 e^{-\lambda t}$$

The time for the number of atoms to be diminished to one half of its original value is called the *half-life* ( $t_{1/2}$ ).

$$N(t) = \frac{1}{2}N_0 = N_0 e^{-\lambda(t_{1/2})}$$

Thus: 
$$\frac{1}{2} = e^{-\lambda t_{1/2}}$$

$$\ln \frac{1}{2} = -\lambda t_{1/2}$$

$$t_{1/2} = \frac{0.693}{\lambda}$$

The *activity* of a sample is simply the number of disintegrations per unit time or  $N$ . The historic unit for activity is the *Curie* (Ci), which is  $3.7 \times 10^{10}$  disintegrations per second (dps). The SI unit for activity is the *Becquerel* (Bq).

$$1 \text{ Bq} = 1 \text{ dps}$$

#### ASSIGNMENT

1. Calculate the mass defect and the binding energy for  ${}_{6}\text{C}^{13}$ .
2. In your own words, explain binding energy.
3. Xenon-135 has a half-life of 9.16 hours. What is its decay constant?
4. Sketch a graph of activity versus time, in half lives, for a radionuclide assuming that the activity is  $A_0$  at time zero.

J.U. Burnham  
J.E. Crist  
A. Broughton

## Nuclear Theory - Course 227

## NEUTRON REACTIONS

---

Nuclear reactions can occur as a result of collisions between various particles or gamma photons and nuclei. Charged nuclear particles, such as protons, deuterons (deuterium or  $H^2$ ) and alpha particles, need to have a large amount of energy (tens of MeV) before they are able to overcome the Coulomb repulsive forces and enter a nucleus.

Neutrons and gamma photons, however, are not charged and are therefore able to interact with nuclei very effectively, even when they have very little energy. In fact, generally speaking, there is a greater chance of a reaction occurring with low rather than high energy neutrons, because the former are in contact with the nucleus for a greater length of time.

The operation of a reactor basically depends on how neutrons react with nuclei in the reactor. It is therefore necessary to look at these reactions, called *neutron reactions*, in some detail. Although there are well over a dozen known neutron reactions, we need only consider the five that are of importance to us.

All neutron reactions can be categorized as either *elastic* or *inelastic collisions*, depending on whether kinetic energy is conserved in the collision or not.

Elastic Collisions

Elastic collisions are those in which the total kinetic energy before the collision is equal to that after the collision.

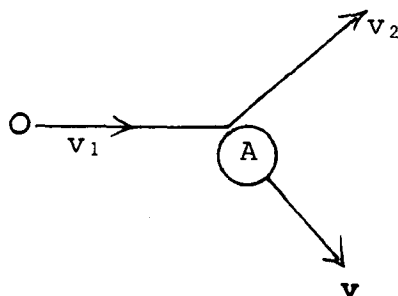

Figure 1

Elastic Collision

For example, in Figure 1 a neutron with speed  $v_1$  strikes a nucleus of mass  $A$  and bounces off at lower speed  $v_2$ . The nucleus of mass  $A$  recoils with speed  $v$ , and if kinetic energy is to be conserved, the kinetic energy received by  $A$  has to be equal to that lost by the neutron. After the collision the neutron will therefore be moving at a slower speed (ie,  $v_2 < v_1$ ).

The fraction of its initial energy that the neutron loses in such a collision depends on two things:

- (a) The angle at which the neutron hits,
- (b) The mass  $A$  of the target nucleus.

The maximum energy loss occurs when the neutron hits the nucleus head-on, and the least energy is lost in a glancing collision. The pool sharks amongst you will be well aware of this - the difference here is that the angle at which the neutron will hit the nucleus will be quite random. Consequently the angle at which it bounces off is also quite random. That is why we say that the neutron is *scattered* in the process. The term *elastic* implies the conservation of kinetic energy and therefore these collisions are described by the term *elastic scattering*.

The lighter the target nucleus is, the greater is the fraction of the energy that a neutron will lose in these collisions. Since this is the reaction with which fast neutrons are slowed down in the moderator, we want light moderator nuclei (ie, Atomic Mass Number less than 16 or so) if we are going to slow the neutrons down in as few collisions as possible. Otherwise the neutrons will travel large distances before they are slowed down thus making a physically large reactor. To emphasize this point, Table I shows the number of elastic collisions neutrons have to make in various materials to slow down from 2 MeV (the average energy with which they are produced at fission) to *thermal energy* (0.025 eV)\*.

Note that for the heavy  $U^{238}$  nucleus, a very large number of elastic collisions would have to occur before the neutron would be slowed down to thermal energy.

---

\*At thermal energy, the neutrons have the same energy as the atoms or molecules with which they are colliding. At room temperature, this is about 0.025 eV.

TABLE I

Number of Elastic Collisions to Thermalize  
Fission Neutrons in Various Materials

$H^1$	18
$H^2$ (deuterium)	25
$H_2O$ (light water)	20
$D_2O$ (heavy water)	36
$C^{12}$ (graphite)	115
$U^{238}$	2172

### Inelastic Collisions

Instead of bouncing off, the neutron may enter a nucleus to briefly form what we call a *compound nucleus*. In such a reaction, kinetic energy is not conserved and it is therefore known as an *inelastic collision*. Basically what happens is that some of the neutron's kinetic energy is taken by the compound nucleus. As a result it becomes unstable in the sense that it cannot exist for very long in this state (ie, for no longer than about  $10^{-14}$  seconds), and the reaction that then occurs will be one of a number of alternatives described below.

1. The compound nucleus may get rid of its excess energy by emitting a neutron and a gamma photon. An example of this is shown in Figure 2. A neutron is shown entering a U-238 nucleus to form a U-239 nucleus. This immediately emits a neutron (any one) and a gamma photon to become U-238 again. The end result is still a slowing down of the neutron because the energy it has lost has been given to the gamma photon.

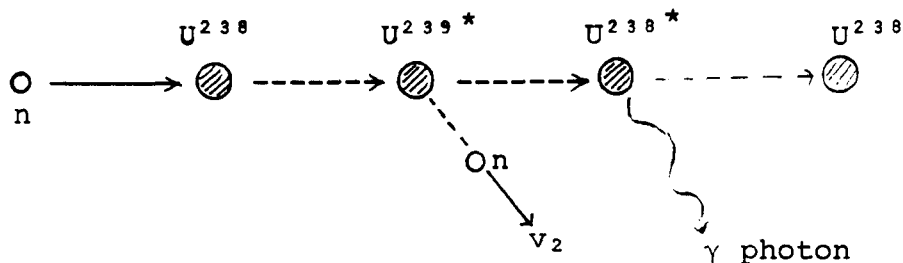

Figure 2

Inelastic Scattering

This reaction is known as *inelastic scattering*; "scattering" because the direction of the emitted neutron is again quite arbitrary. One of the peculiarities of this reaction is that it cannot occur unless the neutron has an initial energy of at least 0.1 MeV (this figure only applies to heavy nuclei like uranium; for lighter nuclei, around 3 MeV or more would be needed before the reaction becomes possible. These figures are based on the possible energy levels discussed in lesson 227.00-1.) From a reactor point of view, we can ignore inelastic scattering everywhere except in the fuel itself, because only there will the neutron energies be large enough for it to happen.

2. An alternative to inelastic scatter is that the compound nucleus may emit either a proton or an alpha particle, and in this way form an entirely new element. Look at Figure 3, which shows such a *transmutation* of oxygen-16.

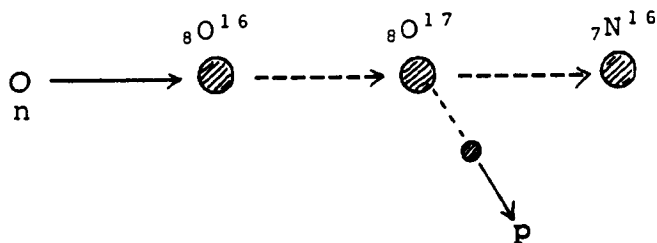

Figure 3  
Transmutation (n,p)

This reaction may be written as



or you may prefer the short-hand version  $\text{O}^{16}(\text{n,p})\text{N}^{16}$ . The N-16 is radioactive and emits high energy gamma radiation. It presents a radiation hazard in any region containing oxygen-16, that has recently been exposed to high energy neutrons. For example, oxygen-16 is present in water (either  $\text{H}_2\text{O}$  or  $\text{D}_2\text{O}$ ), and if this water has recently flowed

through the reactor, some of the oxygen-16 will have been changed to nitrogen-16, and this will now emit high energy gamma radiation.

Although transmutation reactions - (n,p) or (n, $\alpha$ ) - are relatively rare, there are two more which are of interest to us:

$B^{10}(n,\alpha)Li^7$ : Reactor instrumentation (ion chambers) for monitoring the neutron population in a reactor operates with this reaction. This reaction releases 2.5 MeV of energy, which shows up as kinetic energy of the helium and lithium nuclei. They lose this energy by producing a large amount of ionization in the counter, and this can easily be detected, even in the high gamma radiation background of a reactor environment. Boron is also used for reactivity control.

$He^3(n,p)H^3$ : Very sensitive reactor instrumentation makes use of this reaction, because it occurs much more readily than the one above. He-3 counters were first used in Ontario Hydro for the first start-up of the Pickering and Bruce reactors.

3. The most common neutron reaction of all is also an inelastic type of reaction. It is called *radiative capture*, because the compound nucleus has *captured* a neutron and it then *radiates* a gamma photon. Radiative capture can occur for practically all types of nucleus, and at all neutron energies. Generally speaking, it is more probable for slow neutrons than for fast neutrons.

An example of such a reaction is shown in Figure 4, which explains how tritium (hydrogen-3) is produced in heavy water reactors.

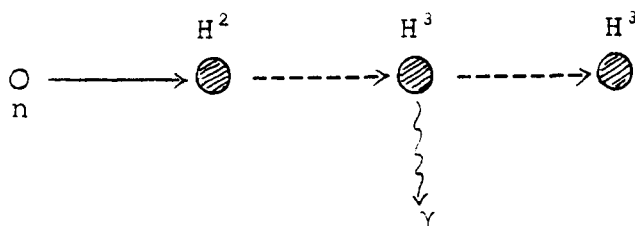

Figure 4  
Radiative Capture (n, $\gamma$ )

Radiative capture is important for two reasons:

- (a) Non-fission neutron capture in core materials is, in a sense, undesirable. However, if the non-fission capture is with U-238 (giving U-239) there is a bonus in the subsequent transmutation of the U-239 to Pu-239. Pu-239 is a fissile nuclide and thus extends the fissile component of the fuel.
  - (b) The product nucleus formed more times than not is radioactive and might present a radiation hazard. For example, corrosion products circulated by the heat transport system will be activated as they pass through the reactor core. When they later plate out in this system, the whole system becomes a radioactive hazard, and will remain so even if the reactor is shut down (ie, if the neutron source is removed). The three most troublesome activation products in our reactors are cobalt-60, manganese-56, and copper-64, and they are produced in this way.
4. The final reaction we are going to consider is called *fission*. The word is borrowed from the biologists, who use it to describe the breaking up of a cell into two new ones.

### The Fission Reaction

Production of nuclear power relies on the fact that some nuclei will fission, and that energy is released during this fission process because a loss of mass occurs ( $\Delta E = \Delta mc^2$ ). There are two types of fission; *spontaneous* and *induced*.

#### (a) Spontaneous Fission

In this reaction, a nucleus fissions entirely spontaneously, without any external cause. It is quite a rare reaction, generally only possible for nuclei with atomic masses of around 232 amu or more. (As the atomic mass number increases, spontaneous fission becomes more and more probable. One could argue that there is an infinite number of heavy elements which do not exist, because they are not stable against spontaneous fission decay). The table on Page 7 shows the spontaneous fission and alpha decay rates of the U-235 and U-238 isotopes.



TABLE IISpontaneous Fission And Alpha Decay Rates of Uranium

	$t_{\frac{1}{2}}(\alpha)$ (years)	$t_{\frac{1}{2}}(\text{s.f.})$ (years)	$\alpha$ decay rate (atoms/s/kg)	s.f. decay rate (atoms/s/kg)
U-235	$7.1 \times 10^8$	$1.2 \times 10^{17}$	$79 \times 10^6$	0.3
U-238	$4.5 \times 10^9$	$5.5 \times 10^{15}$	$12 \times 10^6$	6.9

From this table you will be able to appreciate that spontaneous fission has no significance in the production of power. (About  $10^{-12}\%$  of full power.) Nevertheless, it is important in that it represents a small source of neutrons in a reactor.

(b) Induced Fission

Certain heavy nuclei can be *induced* to fission as a result of neutron capture. In most cases the energy of the captured neutron must be very high before fission can occur, and therefore we can restrict our discussion to those nuclei which can be fissioned by neutron energies likely to be found in a reactor. In practice, we are then dealing with neutrons ranging from 10 MeV down to *thermal energies*.

Practical Fission Fuels

The only nuclei of practical importance to us are the U-235 and U-238 isotopes of uranium, and the Pu-239 and Pu-241 isotopes of plutonium. For all of these, except U-238, fission with thermal neutrons (*thermal fissions*) is much more probable than fission with fast neutrons (*fast fissions*). This is an important (and desirable) nuclear property, and such nuclides are said to be *fissile*. U-238, which will not fission with thermal neutrons, but which will fission with fast neutrons of energy greater than about 1.2 MeV, is merely said to be *fissionable*. It makes a small direct contribution to the power produced in a reactor, (about 3%).

Note: Fissile describes a nucleus that can be fissioned by thermal neutrons but such a nucleus can also be fissioned by neutrons of any energy.

Natural uranium only contains U-235 (0.72%) and U-238. Over a period of reactor operation, Pu-239 and also some Pu-241 will be built up in the fuel as a result of neutron capture:

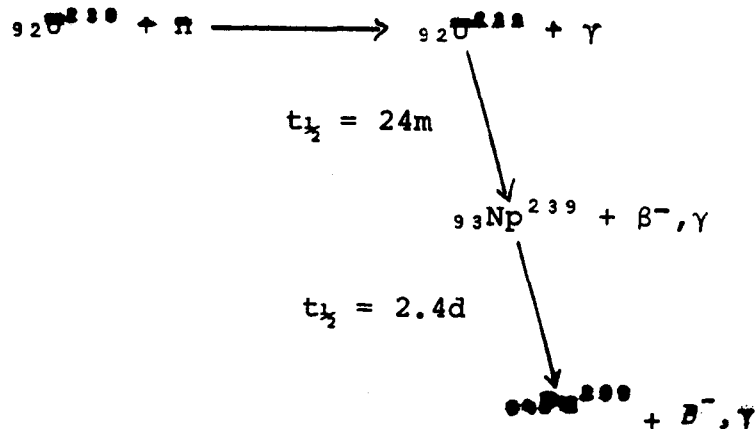

Pu-239 is fissile like U-235. If it does not undergo fission, it may capture a neutron to form Pu-240. Although this is fissionable it is much more likely to capture another neutron to form fissile Pu-241. A significant fraction of the total power produced by fuel during its life in our reactors is due to fission of the fissile plutonium isotopes. We will deal with this in more detail later on in the course.

### Fission Fragments

The fission fragments formed when spontaneous or induced fission occurs are two new nuclei. These may be any two of about 300 nuclides which are known to be formed as a result of fission.

Figure 5 (on Page 9) shows the relative frequency for nuclides of specific mass numbers produced as fission fragments. Such a curve is known as a *fission yield curve* (since two fragments are produced per fission, the area under the curve adds up to 200%). You can see that both fission fragments are likely to consist of a substantial piece of the original nucleus. They are likely to have mass numbers between 70 and 160, with those around 95 and 140 being the most probably. Note that symmetrical fission (equal fragments) is quite rare.

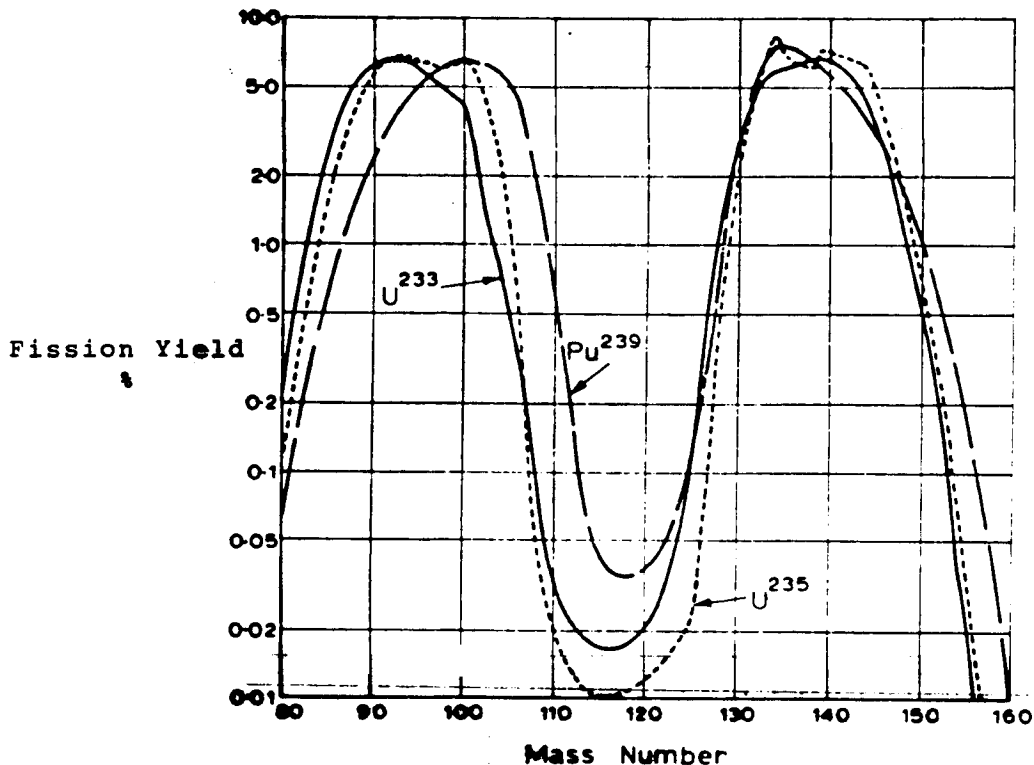

Figure 5

Fission Yield of U-233, U-235 and Pu-239

The fission fragments are almost invariably radioactive. The reason for this is that the neutron/proton ratio of the fragments is about the same as that of the fissioned nucleus, and this is too high for stability at medium mass numbers. The fragments will therefore try to reduce their n/p ratio by successive  $\beta^-$ ,  $\gamma$  decays until stability is reached. A typical decay chain is shown in Figure 6 (on Page 10). All the members of such chains are known as *fission products*.

The half-lives of fission products range from fractions of a second to thousands of years. (It is this activity that causes so much concern in atomic bomb fall-out.) There are four important consequences of fission product production in the fuel:

- (a) The fission products must be held in the fuel by encasing it in a sheath, so that they do not enter the heat transport system and hence leave the reactor core. As long as the fission products remain in the fuel and the fuel remains adequately shielded there is no biological risk.

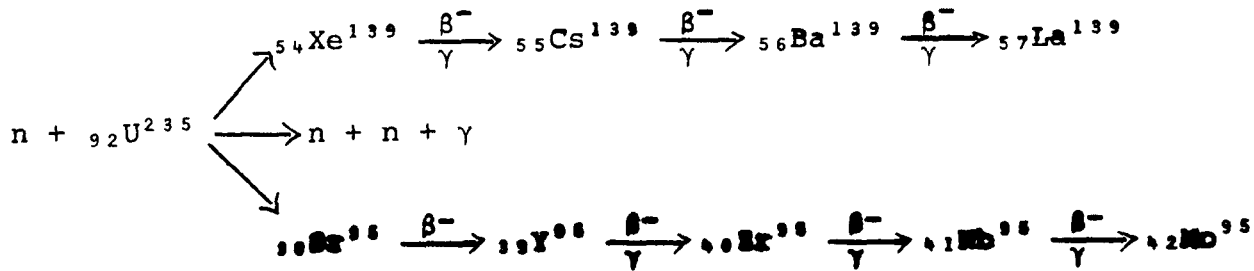

Figure 6  
Fission Product Decay Chain

- (a) Continued: Since many of them have long half-lives, their presence in the heat transport system would be a radiation hazard which would prevent access to equipment even when the reactor is shut down.
- (b) Heavy shielding is required around the reactor to avoid exposure to the gamma radiation emitted by the fission products.
- (c) Fuel must be changed remotely, and special precautions must be taken in handling and storing spent fuel.
- (d) Some of the fission products have a high affinity for neutrons and thereby *poison* the reactor. The two most important poisons are Xe-135 and Sm-149. They are produced in a relatively high percentage of fissions, and they capture a significant number of neutrons.

#### Prompt and Delayed Neutron Emission

The fission fragments are produced in an excited state and will immediately emit perhaps two or three neutrons and some gamma photons. These are called *prompt neutrons* and *prompt gammas*.

Figure 7 (on Page 11) shows the energy distribution of prompt neutrons. The average energy is about 2 MeV, although the most probable energy is only 0.72 MeV.

A very small number of neutrons (less than 1%) appear long after fission occurs, and these are known as *delayed neutrons*. They arise from the radioactive decay of certain

fission product daughters. For example:

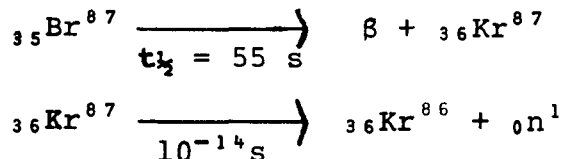

The neutron emission is instantaneous (with respect to Kr-87), but obviously occurs some time after the original fission because the Br-87 must decay first. In fact, it appears to be emitted with the 55 second half-life of Br-87.

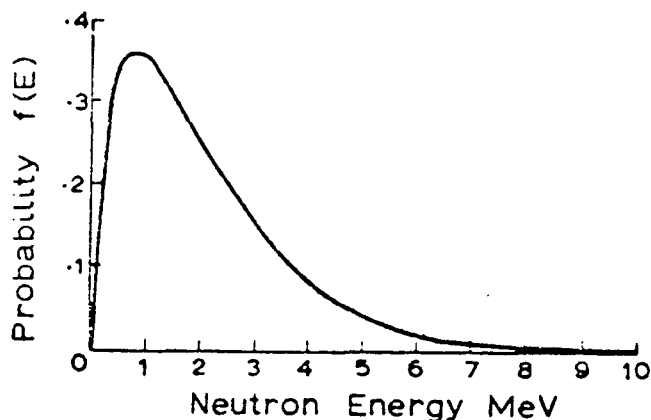

Figure 7  
Prompt Neutron Energy Spectrum

Nuclei such as  $\text{Br}^{87}$  whose production in fission may eventually lead to the emission of a delayed neutron are known as *delayed-neutron precursors*. At the present time, it is believed that there may be as many as twenty precursors, although only about half a dozen have been positively identified. These precursors and their respective half-lives are given in Table II (on Page 12). They are usually divided into six groups according to their half-lives.

TABLE IIIDelayed-Neutron Precursors

(Uncertain Quantities are Indicated by Brackets)

Precursor	Half-life and Group (Seconds)	
Br <sup>87</sup>	54.5	Group 1
I <sup>137</sup>	24.4	Group 2
Br <sup>88</sup>	16.3	
I <sup>138</sup>	6.3	
Br <sup>(89)</sup>	4.4	Group 3
Rb <sup>(93 94)</sup>	6	
I <sup>139</sup>	2.0	
(Cs, Sb or Te)	(1.6-2.4)	Group 4
Br <sup>(90 92)</sup>	1.6	
Kr <sup>(93)</sup>	~1.5	
(I <sup>140</sup> + Kr?)	0.5	Group 5
(Br, Rb, As + ?)	0.2	Group 6

For thermal fission of U-235, the total contribution of all the delayed neutrons (called the delayed neutron fraction;  $\beta$ ) is only 0.65% of the total neutrons produced. With Pu-239, the delayed neutron fraction is even less at 0.21%. Despite the fact that these fractions are quite small, they have a very important effect on the time dependent behaviour of thermal reactors. We shall discuss this aspect of delayed neutrons in a later lesson.

Table IV (on Page 13) gives the probability of a particular number of neutrons being emitted in the thermal fission of a U-235 nucleus. This includes both prompt and delayed neutrons.

TABLE IVNeutron Emission in Thermal Fission of U-235

Number of Neutrons Emitted	Number of Cases per 1000 Fissions
0	27
1	158
2	339
3	302
4	130
5	34

The average number of neutrons emitted per fission is a very important quantity in reactor physics. It is usually denoted by the Greek letter  $\nu$  ("new"). For thermal fissions of U-235,  $\nu = 2.43$ . (Fast fissions, ie, fissions caused by fast neutrons, usually produce marginally more neutrons.) It is also interesting to compare the number of neutrons released per thermal fission of Pu-239 and Pu-241 since both of these plutonium isotopes build up in our fuel after a while.

TABLE VValues of  $\nu$  for Thermal Fissions

Fissile Nucleus	$\nu$
U -235	2.43
Pu-239	2.89
Pu-241	2.93

Energy Release From Fission

About 200 MeV of energy is liberated when a nucleus fissions. The exact value slightly depends on the fissile nucleus and on the fission fragments produced. The energy can be calculated as follows:

Consider the example given in Figure 6 on page 10:

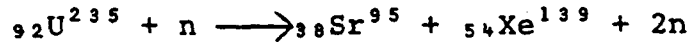

Total mass before fission = 235.044 + 1.009 = 236.053 amu

Total mass after fission = 94.903 + 138.918 + 2.018 = 235.839 amu

Loss in mass = 0.214 amu

This corresponds to almost 200 MeV. A summary of how this energy is distributed is given in Table VI.

TABLE VI

Approximate Distribution of Fission Energy Release in U-235

Kinetic energy of lighter fission fragment	100 MeV
Kinetic energy of heavier fission fragment	69 MeV
Energy of prompt neutrons	5 MeV
Energy of prompt $\gamma$ rays	6 MeV
$\beta$ particle energy gradually released from fission products	7 MeV
$\gamma$ ray energy gradually released from fission products	6 MeV
Neutrinos (energy escapes from reactor)	<u>11 MeV</u>
	<u>Total 204 MeV</u>

This is not a complete account of all the energy released in the reactor. Some of the neutrons even after losing all their kinetic energy may produce (n, $\gamma$ ) reactions with materials in the reactor, and up to about 8 MeV may be released in such reactions. The total amount of energy produced in a reactor per fission may therefore depend to a slight extent on the form of the reactor, but it is always within a few MeV of 200 MeV.



Not all of this 200 MeV of energy from fission is useful or desirable. The principal useful heat is due to the kinetic energy of the fission fragments. This shows up as heating of the fuel from which the heat is transferred to the heat transport fluid. Most of the neutron and about one third of the gamma energy ( $\approx 5-6\%$  of the total) shows up as heating of the moderator. This is essentially waste heat which must be rejected. The energy due to decay of the fission products makes up about 7% of the total fission energy. This has a major effect on reactor design since this energy shows up as heat for a long time after essentially all fissioning has ceased. Because of this decay heat we must have a shutdown cooling system for normal shutdown conditions and an emergency core cooling system in the event that normal cooling is lost. As demonstrated at 3 Mile Island, even when shut down a reactor is still producing about 1% of its full thermal power.

### Reactor Power and Fuel Consumption

The 200 MeV released in one fission is not of much practical value because it is minute. In fact, 1 watt of power requires  $3.1 \times 10^{10}$  fission every second.

One Megawatt steady power requires  $3.1 \times 10^{16}$  fissions every second continuously.  $3.1 \times 10^{16}$  atoms of U-235 have a mass of:

$$\frac{3.1 \times 10^{16} \times 235}{6.023 \times 10^{26}} = 1.21 \times 10^{-8} \text{ kg}$$

Therefore, to produce 1 Megawatt-day of energy from fission requires the complete fissioning of:

$$1.21 \times 10^{-8} \times 24 \times 3600 = 1.0 \times 10^{-3} \text{ kg} = \underline{1.0 \text{ g U-235}}$$

The first requirement for producing useful power from the fission process is that enough U-235 nuclei must be available for fissioning. This requirement is met by installing sufficient U-235 in the reactor in the form of fuel rods. If natural uranium is used, of which 0.72% is U-235, then about 140 g of uranium would be used to produce 1 Megawatt-day of energy. This assumes that all the U-235 could be fissioned. In practice this is not so, because some U-235 ( $\approx 14\%$ ) is consumed in (n, $\gamma$ ) reactions. As a result, 165 g of natural uranium would be used.

For example, a Pickering reactor at full power generates 1744 MW from fission (540 MW gross electrical power). It would therefore use about 290 kg of natural uranium a day on this basis. Because Pu-239 (and Pu-241) is produced in the fuel after a while, this contributes substantially to energy production, and the amount of fuel used is consequently smaller.

### Production of Photoneutrons

Prompt and delayed neutrons are produced as a result of fission. If no further fissions occur, no more prompt or delayed neutrons will be produced. This is not the case with *photoneutrons*.

Photoneutrons are peculiar to reactors with heavy water moderator or heat transport fluids. They are produced when photons with energies greater than 2.2 MeV are captured by deuterium nuclei:



After the reactor has been operating for a while, it will have built up in the fuel an inventory of fission products whose gamma decay photons have an energy greater than 2.2 MeV. Even when the reactor is shut down, this photoneutron source will persist because the gamma rays from decaying fission products can still produce photoneutrons in any heavy water present in the core. Even if the moderator has been dumped, heavy water will always be in the core as heat transport fluid. Therefore in our heavy water cooled reactors we always have a relatively large neutron source (compared to the spontaneous fission source) with which to start the reactor up again after a shutdown.

### ASSIGNMENT

1. Explain why we use materials with a low atomic mass for moderators.
2. Table II shows the spontaneous fission rate for U-238 as 6.9 fissions/s/kg. Is this fission rate of any significance? Explain your answer.
3. How long will it take delayed neutrons to come into equilibrium after a power change?

J.U. Burnham  
J.E. Crist

## Nuclear Theory - Course 227

## NEUTRON CROSS SECTIONS, NEUTRON DENSITY AND NEUTRON FLUX

Neutron Cross Sections

Let us have a look at the various reactions a neutron can undergo with a U-235 nucleus:

As mentioned in lesson 227.00-2:

1. If the neutron energy is greater than 0.1 MeV, inelastic scattering may occur. If the neutron energy is less than this, there is no chance of this reaction happening.
2. The neutron may just bounce off (elastic scattering), and this can happen at all neutron energies.
3. The neutron may be captured (radiative capture).
4. The neutron may cause fission.

Radiative capture and fission are much more likely for slow neutrons than for fast neutrons, and fission is always more probable than radiative capture.

Thus we are always comparing the chances in favour of the various reactions taking place. It is the probability of a certain reaction occurring that is important. Some reactions are more probable with some nuclei than with others or more probable with some neutron energies than with others. Because these reactions are concerned with a neutron striking a target, namely a nucleus, the probability that a certain reaction will occur is measured in terms of an area, called the *Neutron Cross-Section*.

To understand this cross-section better, imagine the neutrons as being bullets shot at the target in Figure 1, instead of at a nucleus. When the neutron misses the target altogether, no reaction takes place. The areas of the various rings on the target represent the chance of various reactions occurring. Thus the area, d, of the complete disc, being the easiest to hit, represents the probability of the easiest reaction occurring. The area to the outside of the single-hatched ring, c, represents the probability of the next easiest reaction occurring. Area b represents the probability of the third easiest reaction occurring and area a, of the bull's eye, the probability of the most difficult reaction occurring, since the bull's eye is the most difficult to hit. The areas of these rings can be such that the probability of an area being hit by a bullet is equal

to the probability of a reaction occurring between the neutron and the nucleus. The area of the ring is, then, the cross-section for that particular reaction. Because these cross-sections apply specifically to individual nuclei, they are known as *microscopic* cross-sections.

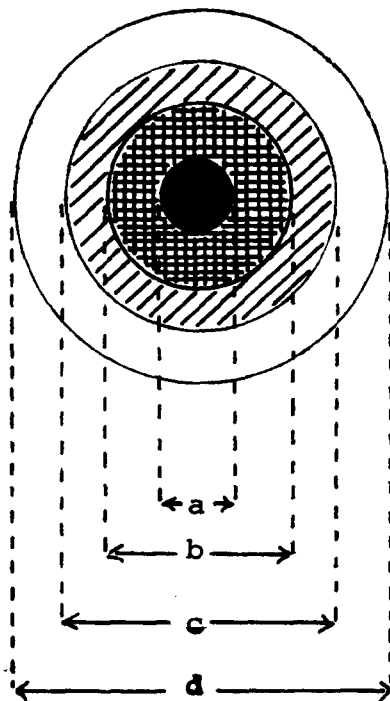

Figure 1

Needless to say the ring areas are extremely small, being of the order of  $10^{-24}$ ,  $10^{-23}$  or  $10^{-22}$  square centimeters. A special unit, called the *barn*, is therefore used to describe these cross-sections.

$$1 \text{ barn} = 10^{-24} \text{ cm}^2$$

The barn is of the same sort of size as the physical target area ( $\pi r^2$ ) presented by a medium sized nucleus.

If a reaction has a large cross section, say 100 b, it will occur much more frequently than one that has a small cross-section, say 0.1 b. In fact, it is exactly 1000 times as likely.

As was pointed out earlier, when there are a number of possible reactions with a given nucleus, each one would have its own cross-section. The Greek letter  $\sigma$  (sigma) is used as the symbol for the microscopic cross-section, and so:

$\sigma_f$  = fission cross section

$\sigma_a$  = absorption cross section

$\sigma_{n,\gamma}$  = radiative capture cross section

$\sigma_i$  = inelastic scattering cross section

$\sigma_s$  = elastic scattering cross section

$\sigma_a$  is usually the radiative capture cross section, ie,  $\sigma_{n,\gamma}$ . Only in those few cases where fission is also possible, (ie,  $\sigma_f \neq 0$ ),  $\sigma_a$  would include  $\sigma_f$  and  $\sigma_{n,\gamma}$  since a neutron is absorbed in both cases;

$$\text{ie,} \quad \sigma_a = \sigma_f + \sigma_{n,\gamma},$$

since both fission and radiative capture involve a complete absorption and loss of the neutron. So, to repeat, for nuclides with  $\sigma_f = 0$ ,  $\sigma_a$  is merely  $\sigma_{n,\gamma}$ .

Cross sections depend very much on the neutron energy. Generally speaking, they are a lot larger at low energies than at high energies. For example, the fission cross-section  $\sigma_f$  for U-235 for neutrons of thermal energy is 580 b, whereas it is only just over 1 b at MeV. In other words, fission of U-235 is about 500 times as likely for thermal neutrons than for fast neutrons. This very nicely illustrates what the moderator does for us.

For your interest, Table I lists the thermal neutron cross-sections of fuel nuclei. It might be quite instructive to have a look at these numbers and see what we can make of them.

In the table  $\sigma_a$  is shown as  $\sigma_f + \sigma_{n,\gamma}$ , since both processes involve a complete absorption of the neutron.

TABLE I

Thermal Neutron Cross Sections of Fuel Atoms (in Barns)  
 (taken from Atomic Energy Review (IAEA), 1969, Vol 7, No 4, p.3)

	$\sigma_f$	$\sigma_{n,\gamma}$	$\sigma_a$	$\sigma_s$	$\nu$
U-233	530.6	47.0	577.6	10.7	2.487
U-235	580.2	98.3	678.5	17.6	2.430
U-238	0	2.71	2.71	$\sim 10$	0
Nat. U	4.18	3.40	7.58	$\sim 10$	
Pu-239	741.6	271.3	1012.9	8.5	2.890
Pu-241	1007.3	368.1	1375.4	12.0	2.934

Only 86% of the thermal neutrons absorbed by U-235 cause fission. You can see that this is just the fraction  $\sigma_f/\sigma_a$ . Note also that U-233 gives the greatest percentage of fission per neutron absorbed ( $\sigma_f/\sigma_a = 92\%$ ); this is a very desirable aspect of U-233, and for this reason it may well be used in future reactors.

The values for natural uranium were obtained by using 99.3% of the U-238 values and 0.7% of the U-235 values. Looking at the table, you can see that for natural uranium  $\sigma_f = 4.18$  b,  $\sigma_{n,\gamma} = 3.40$  b and hence  $\sigma_a = 7.58$  b. This means that for every, say, 758 thermal neutrons absorbed in natural uranium, 418 will cause fission. Since these fissions can only occur in U-235, we will get  $\nu = 2.43$  new neutrons produced per fission. The 418 fissions will therefore generate  $418 \times 2.43 = 1016$  new neutrons. This means that for every thermal neutron absorbed in natural uranium fuel, we will on average get back  $1016/758 = 1.34$  new ones.

In our reactors this is a sufficient number because we have relatively few neutron losses in reactor materials (in other words, the absorption cross-sections of the reactor materials we use are small enough). However, the U.S. reactors use a light water moderator. Light water has an absorption cross-section that is almost 700 times greater than that of heavy water. As a result, the light water absorbs so many neutrons that 1.34 new neutrons for every neutron absorbed in the fuel are not enough. They therefore use *enriched* fuel, ie, the U-235 concentration is greater than the naturally occurring one of 0.72%. You might

like to work out for yourself (using the values given in Table I) what difference an enrichment of 2% U-235 makes (2% enrichment means 2% U-235 and 98% U-238).

Now that we have described what cross sections are, let us take this discussion a little further. Imagine  $1 \text{ cm}^3$  cube of a certain kind of material, and let this cube contain  $n$  thermal neutrons. These  $n$  neutrons are all zipping around inside the

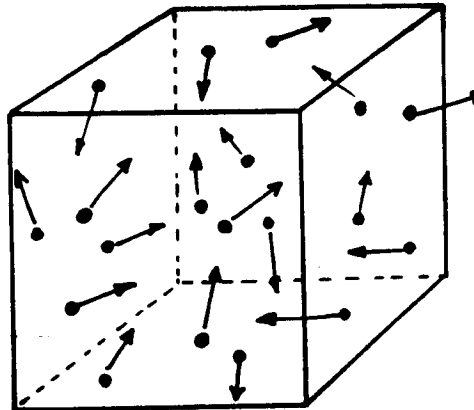

cube with velocity  $v$  and they will make collisions with the nuclei sitting there. We will assume that there are  $N$  nuclei in the  $1 \text{ cm}^3$  cube, and that their absorption ( $n, \gamma$ ) cross-section is  $\sigma_a$ . It turns out that the number of neutrons interacting (ie, being absorbed) per second is given by:

$$R = nv.N\sigma_a \quad (1)$$

$R$  is called the *reaction rate*. Intuitively you can see that the expression for  $R$  seems reasonable, because:

- (a) The larger  $n$ , the more neutrons will make collisions
- (b) The larger their velocity, the more nuclei they will get to hit in a certain time,
- (c) The larger the number of nuclei present ( $N$ ) the more will be hit, and
- (d) The larger the cross-section, the greater is the probability of getting a hit.

This result is quite general, and if we were to use  $\sigma_f$  instead of  $\sigma_a$  in the expression,  $R$  would be the number of fissions per second. The quantities  $N$  and  $\sigma$  are both characteristic of the so-called target material, and therefore they are often combined to form the

$$\text{macroscopic cross section } \Sigma = N\sigma \quad (2)$$

$\Sigma$  is the capital  $\sigma$ , and note the spelling macroscopic instead of microscopic.

The units of  $\Sigma$  will be  $\text{cm}^{-1}$ . For example, let us work out  $\Sigma_a$  for natural uranium.  $N$  is  $0.048 \times 10^{24}$  nuclei/ $\text{cm}^3$  and from Table 1  $\sigma_a$  is seen to be 7.58 barns.

$$\begin{aligned} \therefore \Sigma_a &= N\sigma \\ &= 0.048 \times 10^{24} \left( \frac{1}{\text{cm}^3} \right) \times 7.58 \times 10^{-24} (\text{cm}^2) \\ &= 0.36 \text{ cm}^{-1} \end{aligned}$$

What does this mean? Well, please take my word for it that  $1/\Sigma_a$ , which is a distance, is the average distance a neutron will travel before being absorbed in the material. That is, thermal neutrons zipping around in natural uranium will travel an average distance of  $1/0.36 = 2.8$  cm before they are absorbed.

Appendix B gives the values of  $\Sigma_a$  for all of the elements and for light and heavy water. The cross-sections apply to thermal neutrons only. This table has been included for interest's sake only, but it does bring out which materials have high neutron capture cross-sections and which don't.

To return now to equation (1), we can write it as

$$R = nv.\Sigma \quad (3)$$

$n$  is the number of neutrons per  $\text{cm}^3$ . We call this the *neutron density*, for rather obvious reasons.



$nv$  is called the *neutron flux*. It is the total distance travelled by all the  $n$  neutrons in  $1 \text{ cm}^3$  in one second, since each of them will cover a distance  $v$ . The Greek letter  $\phi$  (phi) is always used for neutron flux. Its units are

$$\frac{\text{neutron cm}}{\text{cm}^3 \text{ s}}$$

It represents the total neutron tracklength per unit volume per unit time. We therefore end up with

$$R = \phi \Sigma$$

To see what sort of use these ideas have, let us look at an operating reactor that has an average thermal neutron density of 100 million, ie,  $n = 10^8 \text{ cm}^{-3}$ . This is a typical figure. The speed of thermal neutrons is still quite high, it is in fact  $2.2 \text{ km/s}$ , that is  $2.2 \times 10^5 \text{ cm.s}^{-1}$  (or 5000 m.p.h., if you like to look at it that way). Therefore, this reactor has an average neutron flux

$$nv = \phi = 2.2 \times 10^{13} \text{ n.cm}^{-2}\text{s}^{-1}$$

If the reactor uses natural uranium, the the absorption rate per  $\text{cm}^3$  of fuel is

$$\phi \Sigma_a = 2.2 \times 10^{13} \times 0.36 = 7 \times 10^{12} \text{ s}^{-1}$$

If the reactor contains  $10^6 \text{ cm}^3$  of fuel (ie,  $1 \text{ m}^3$ ) then there will be

$$7 \times 10^{12} \times 10^6 = 7 \times 10^{18} \text{ neutron captures per second.}$$

Going back to Table I, you can see that 4.18 in every 7.58 neutrons captured will cause fission. We will then have

$$\frac{4.18}{7.58} \times 7 \times 10^{18} = 3.8 \times 10^{18} \text{ fissions per second.}$$

We saw earlier that  $3.1 \times 10^{10}$  fissions per second will produce 1 watt, therefore in this case the reactor is producing

$$\frac{3.8 \times 10^{18}}{3.1 \times 10^{10}} \text{ watts} = 123 \times 10^6 \text{ W} = \underline{123 \text{ MW}} \text{ (thermal)}$$

### Chart of the Nuclides

We have now covered all the material necessary to use the chart of the Nuclides which is included as Appendix C. For those self-studying this course, a few minutes spent studying the explanation of the chart will be time well spent.

### Variation in Cross Sections

As mentioned, neutron cross sections are highly energy dependant. The variation in cross section is not a simple function of neutron energy. Figure 2 shows the variation of the absorption cross section of U-238 with energy. Of particular interest here are the pronounced peaks between  $\sim 5$  eV and  $\sim 1$  keV. These are called resonance absorption peaks and the corresponding energies resonance energy. The cross sections are so high in these regions that a large portion of the neutrons at these energies will be absorbed.

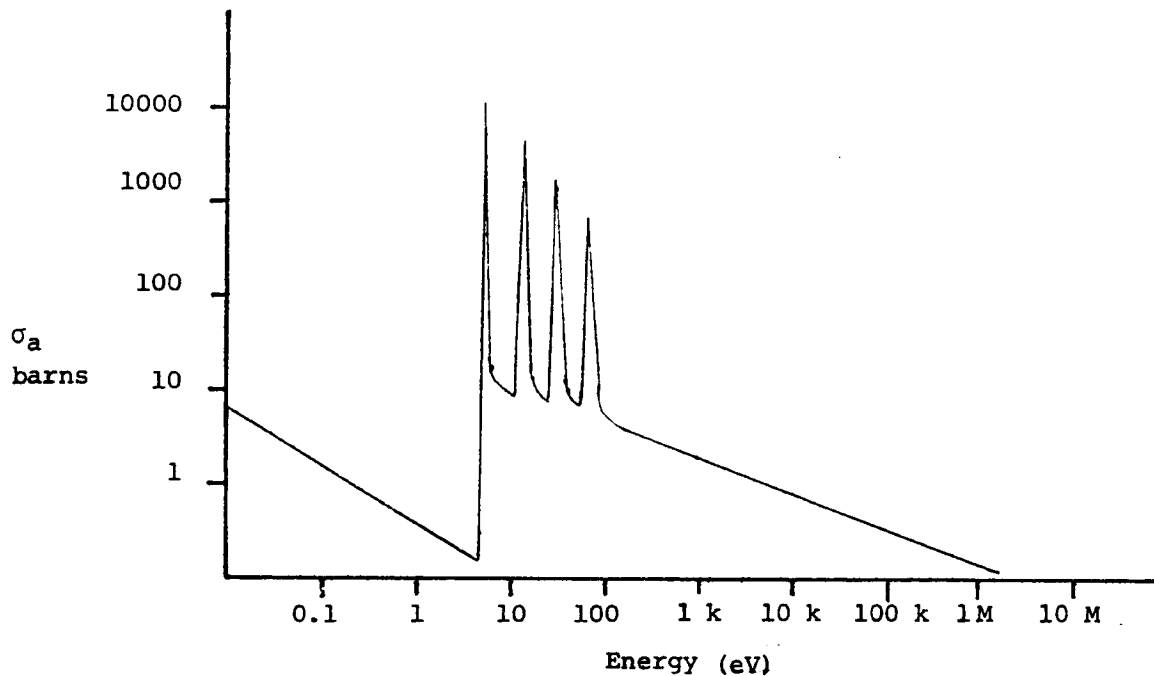

Variation of the absorption cross section of U-238 with neutron energy.

Figure 2

All cross sections have some energy dependance. At low energies most cross sections are inversely proportional to the neutron velocity, ie,

$$\sigma \propto \frac{1}{v} \text{ or } \frac{1}{\sqrt{E}}$$

Variations from this normal behavior will be covered when they have an effect on overall behavior of the reactor.

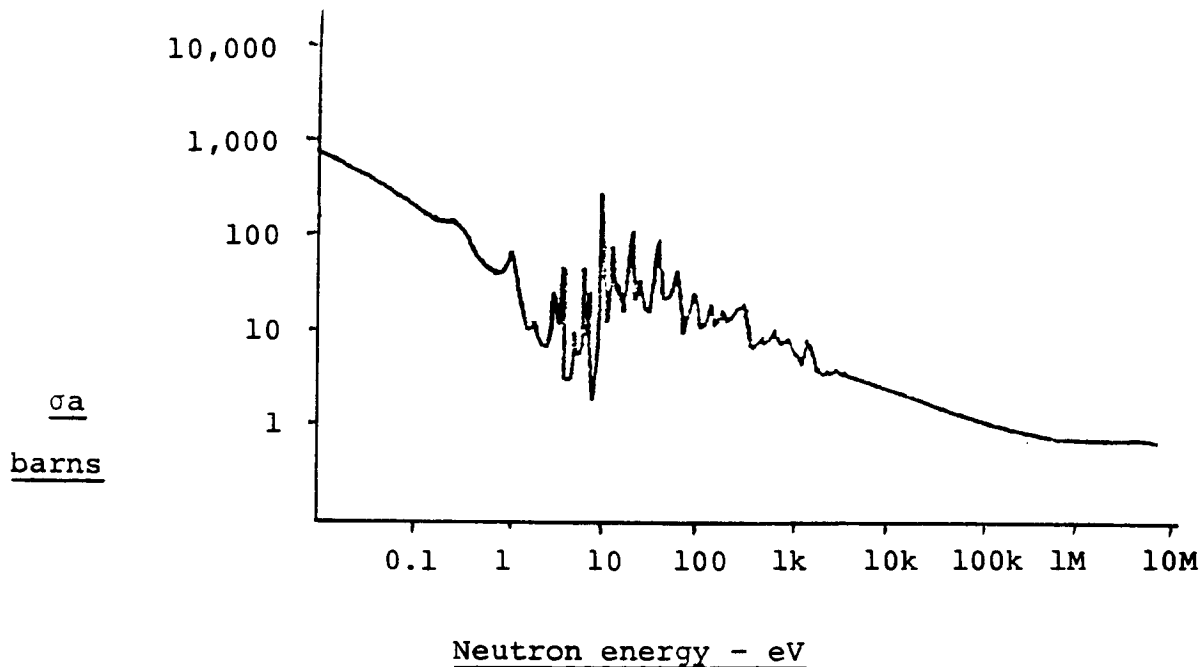

Variation of the absorption cross section  
of U-235 with neutron energy.

Figure 3

ASSIGNMENT

1. Explain what a microscopic neutron cross section is.
2. If 100 thermal neutrons were absorbed by natural uranium, how many fast neutrons would be produced? What is the significance of your answer?
3. Using the Chart of the Nuclides, trace the radioactive decay of U-238 to a stable nuclide.
4. If a thermal neutron interacts with a U-235 nucleus, calculate the probability that the interaction will be a scattering reaction.

J.U. Burnham  
J.E. Crist  
A. Broughton

## Nuclear Theory - Course 227

## THERMAL REACTORS (BASIC DESIGN)

When a U-235 nucleus fissions an average of 2.5 neutrons are released in addition to the energy. This suggests that these neutrons could be used to cause additional fissions thus creating a chain reaction. Assume we have natural uranium (0.72% U-235) as fuel. Let us start with some numbers of fission neutrons (say 1000). These neutrons have an average energy of about 2 MeV (see Table 4, lesson 227.00-2). Since the fission cross-section of U-235 is about 1 barn at this energy it seems reasonable to "slow" the neutrons to low energy where the fission cross-section is much higher (580 barns for a neutron energy of 0.025 eV). We can rapidly reduce the energy of a neutron by having it undergo elastic collisions with a light nucleus (H, He, C, etc). As a result we obtain neutrons which are in thermal equilibrium with their surroundings and are therefore called "thermal neutrons". At a temperature of 20°C a thermal neutron has an energy of 0.025 eV.

During the slowing down process the neutrons pass through the resonance absorption energies of the U-238. If the fuel and moderator were intimately mixed (homogeneously) too many of the neutrons would suffer resonance capture and a chain reaction could not be sustained. If, however, we separate the fuel into discrete locations within the moderator, ie, using fuel channels, the neutrons can slow down away from the U-238 thus avoiding resonance capture.

At thermal energies the neutrons diffuse around until they are absorbed by the fuel, or leak out of the reactor, or are absorbed by something other than the fuel (moderator, fuel sheath, pressure tubes, etc). By careful choice of reactor materials we can limit the non-fuel or parasitic absorption. In addition we can reduce leakage by careful design of the size and shape of the reactor. Of the neutrons absorbed by the fuel, some will cause fission while others will simply undergo radiative capture. If enough of the neutrons cause fissions to give us the 1000 neutrons we started out with then we have a self-sustained chain reaction. We can define a neutron multiplication factor ( $k$ ) for this reaction as:

$$k = \frac{\text{number of neutrons in one generation}}{\text{number of neutrons in the preceding generation}} *$$

\*Note that this definition is only valid when the effects of source neutrons (photoneutrons and spontaneous fission neutrons) are negligible.

For the chain reaction to be self-sustaining  $k \geq 1$ . We will deal with  $k$  in more detail in the next lesson. The remainder of this lesson will deal with moderator properties, reducing neutron leakage, and spacing of the fuel channels.

### Moderator Properties

The primary objective of a moderator is a lot easier to express than to achieve: the fission neutrons must be slowed down to thermal energies without being absorbed. Let us examine the latter aspect first:

There are two possibilities:- the neutrons can be absorbed by the moderator atoms themselves or by fuel atoms, and this can occur anywhere in the energy range from  $\sim 2$  MeV (fission neutrons) down to 0.025 eV (thermal neutrons). Absorption by moderator atoms can obviously be minimized by choosing a moderator with a sufficiently low absorption cross-section, but for fuel the argument is rather more subtle.

Recall that U-238 exhibits a number of severe absorption peaks between 5 eV and 1 keV. It is essential to minimize resonance capture, and one way of doing this is to ensure that, in the slowing down process, the neutron energy loss per collision is as high as possible. For example, consider the moderators in Figure 1 (for the sake of simplicity the resonances have been smoothed out).

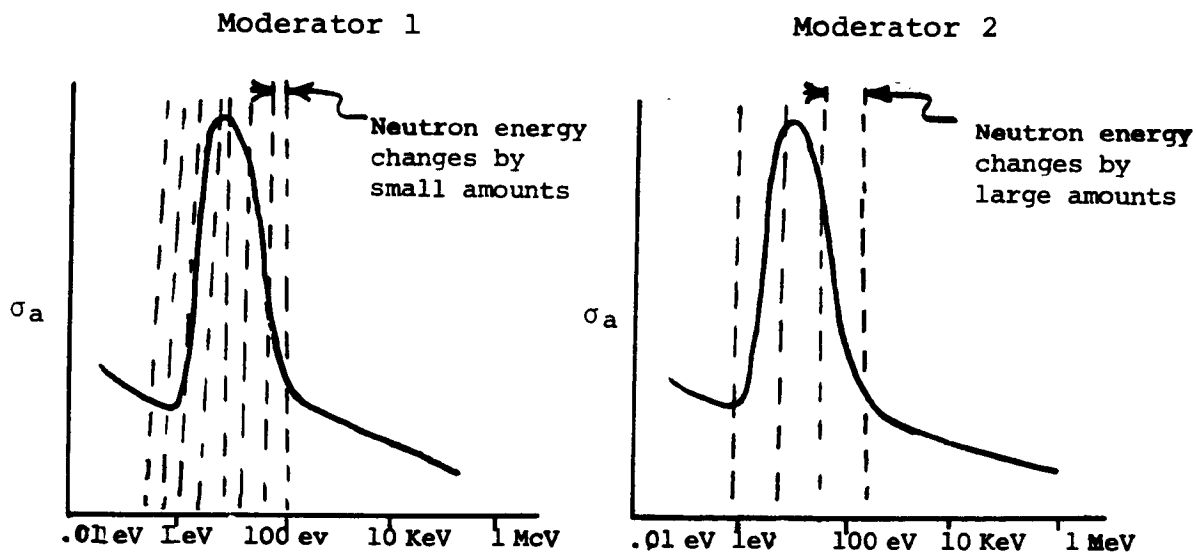

Figure 1

Effect of Moderator on Resonance Capture

Moderator 2 thermalizes the neutrons in far fewer collisions than Moderator 1. This means that the neutrons in Moderator 2 will spend less time in the resonance energy region, and will therefore also have less chance of colliding with U-238 while they have this energy. If they do collide, they will almost certainly be captured. The conclusion is that there will be less resonance capture in U-238 with Moderator 2 than with Moderator 1.

### Slowing Down Mechanism

Having established that we want to slow the neutrons down in as few collisions as possible we shall now examine how this might be achieved.

There are two slowing down mechanisms:

- (1) inelastic scattering (with fuel nuclei)
- (2) elastic scattering (with moderator nuclei)

(Inelastic scattering with moderator nuclei is not possible because the neutron energies are too low, and even with uranium nuclei it is only possible down to about 100 keV. In any case, it is relatively unimportant. Elastic scattering with fuel nuclei may be ignored, because the energy loss per collision is negligible).

In an elastic collision the energy lost by a neutron depends on the mass of the target nucleus and the angle of collision. Since the angle of collision is totally random, a mathematical function can account for its effect. By manipulating equations for conservation of momentum and conservation of kinetic energy we could prove that, the most energy is lost when a neutron collides with a target of equal mass and that for targets of general mass A the energy lost is a simple function of the mass of the target.

It takes a number of collisions for a fast (2 MeV) neutron to slow to thermal energy (0.025 eV) and the larger the mass of the target nucleus, the larger the number of collisions required. This is due to the fact that a smaller portion of the neutron's energy is lost per collision. The mathematical function used to express this is the mean logarithmic energy decrement  $\xi$  (xi).

$$N\xi = \ln \frac{E_i}{E_f}$$

Where:  $\xi$  = mean log energy decrement  
 N = number of collisions to thermalize  
 $E_i$  = initial neutron energy  
 $E_f$  = final neutron energy

and  $N\xi$  = total E loss going from  $E_i$  to  $E_f$

Table I shows the accurate values of  $\xi$  of a number of light materials which might be suitable as moderators.

TABLE I  
Mean Logarithmic Decrements

	$\xi$	Collisions to Thermalize
H <sup>1</sup> *	1.000	18
H <sup>2</sup> *	0.725	25
He <sup>4</sup> *	0.425	43
Be <sup>9</sup>	0.206	83
C <sup>12</sup>	0.158	115
H <sub>2</sub> O	0.927	20
D <sub>2</sub> O	0.510	36
BeO	0.174	105

\*Gases at STP

#### Slowing Down Power and Moderating Ratios

A small number of collisions to thermalize is obviously desirable, but this is of no use on its own unless the collisions actually occur. This implies that the probability of a collision must be high, that is  $\Sigma_s$  should be large. Recall that:

$$\Sigma_s = \sigma_s N$$

This immediately rules out gases as moderators, because  $N$  would be too small for the neutrons to be slowed down within a reasonable distance.

The overall effectiveness of a material for slowing down neutrons is measured by the product  $\xi \Sigma_s$  which is known as the *Slowing Down Power*.

Table II shows the slowing down powers of the solid and liquid moderators. The value of the slowing down power is also shown to demonstrate the unsuitability of a gas.

TABLE II  
Slowing Down Powers and Moderating Ratios

	$\xi$	$\Sigma_s$ (cm <sup>-1</sup> ) (a)	$\xi\Sigma_s$	$\Sigma_a$	$\xi\Sigma_s/\Sigma_a$
He <sup>(b)</sup>	0.425	$21 \times 10^{-6}$	$9 \times 10^{-6}$	? very small	? large
Be	0.206	0.74	0.15	$1.17 \times 10^{-3}$	130
C <sup>(c)</sup>	0.158	0.38	0.06	$0.38 \times 10^{-3}$	160
BeO	0.174	0.69	0.12	$0.68 \times 10^{-3}$	180
H <sub>2</sub> O	0.927	1.47	1.36	$22 \times 10^{-3}$	60
D <sub>2</sub> O	0.510	0.35	0.18	$0.33 \times 10^{-4}$ (d)	5500 <sup>(d)</sup>
D <sub>2</sub> O	0.510	0.35	0.18	$0.88 \times 10^{-4}$ (e)	2047 <sup>(e)</sup>
D <sub>2</sub> O	0.510	0.35	0.18	$2.53 \times 10^{-4}$ (f)	712 <sup>(f)</sup>

- (a)  $\Sigma_s$  values of epithermal neutrons  
(ie, between  $\sim 1$  and  $\sim 1000$  eV)
- (b) at S.T.P.
- (c) reactor-grade graphite
- (d) 100% pure D<sub>2</sub>O
- (e) 99.75% D<sub>2</sub>O
- (f) 99.0% D<sub>2</sub>O

Not only must the moderator be effective in slowing down neutrons, but it must also have a small capture cross-section. Neutrons are slowed down to decrease radiative captures compared to fission captures, and obviously the whole purpose of moderation would be defeated if the moderator nuclei themselves captured neutrons.

A reasonable indication of the overall quality of a moderator is the *Moderating Ratio*, which combines the slowing down power and the macroscopic capture cross section:

$$\text{Moderating Ratio} = \frac{\xi\Sigma_s}{\Sigma_a}$$



We are now in a position to draw some interesting conclusions from Table I.

H<sub>2</sub>O has excellent slowing down properties, and is often used as a fast neutron shield (neutrons must be slowed down before they can be absorbed. Why?) Unfortunately its  $\Sigma_a$  is too high to permit its use as a moderator for natural uranium fuel, and enrichment is necessary.

Be, BeO and graphite have lower values of  $\Sigma_a$ , and can be used with natural uranium fuel provided the fuel is in metal form. The use of natural uranium compounds with more attractive physical and chemical properties (such as UO<sub>2</sub> or UC) is not feasible with these moderators, because of the reduction in the concentration of uranium atoms. The British line of power reactors used a graphite moderator with natural uranium metal fuel (their earlier Magnox stations), and in the early '60s they changed to graphite with enriched UO<sub>2</sub> fuel (the AGR stations).

In the U.S., an abundance of U-235 produced for weapons and a tradition of using it in nuclear submarines led to all out development of light water reactors with relatively highly enriched fuel and a relatively poor moderator.

You can see from Table I that heavy water is by far the best moderator as far as its nuclear properties go, and of course its use was adopted for the CANDU line of reactors (CANDU = CANadian-Deuterium-Uranium). Its  $\Sigma_a$  is so low that natural uranium can even be used in compound form as UO<sub>2</sub>.

The substance used as a moderator must be very pure. It is usually used, in a reactor, in larger amounts than any other material, eg, the volume of carbon in a graphite moderated reactor is 70 to 80 times that of the fuel. A very small amount of impurity in a moderator can substantially increase its capture cross-section. The addition of 1 boron atom to every million graphite atoms would increase the capture cross-section of graphite by 25%

For the same reason the isotopic purity of D<sub>2</sub>O must be kept high. The addition of 0.25% H<sub>2</sub>O to pure D<sub>2</sub>O more than doubles the capture cross-section. Thus, the isotopic purity of moderator D<sub>2</sub>O is kept at 99.75% by weight or better. This is known as *reactor-grade D<sub>2</sub>O*. As you might surmise from the moderating ratio, it would be difficult if not impossible to keep the reactor critical if the isotopic were allowed to drop to 99%. For a more practical approach, Figure 2 shows the change in reactivity with moderator isotopic. Downgrading of the moderator by only 0.1% will introduce about -4 mk. (By contrast downgrading of the heat transport fluid is less important simply because the volume is much less. Thus, downgrading of the heat transport fluid to 95% isotopic will introduce about -5 mk.)

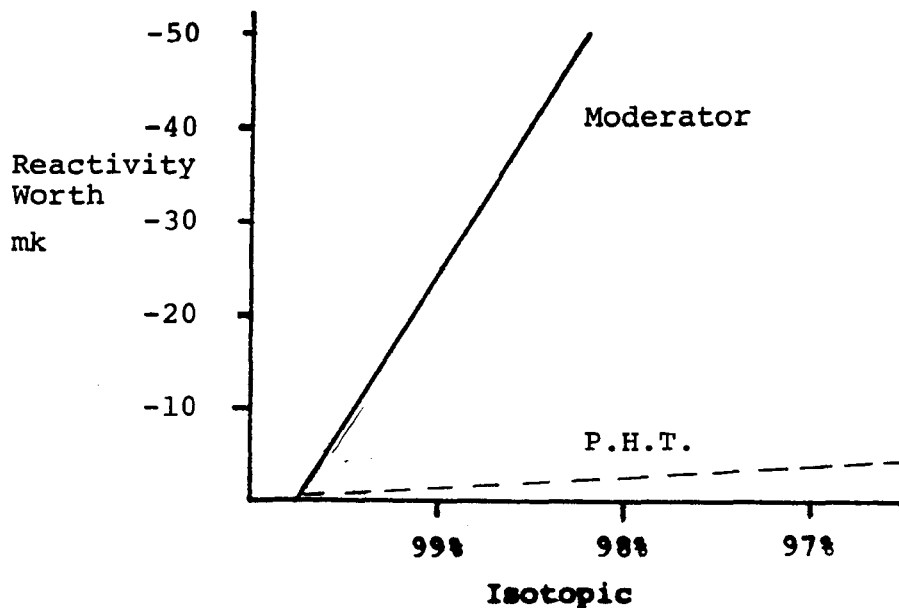

Figure 2

Effect of Moderator or P.H.T. Downgrading

The Diffusion of Neutrons Through the Moderator

Many parameters which determine the design of a reactor are dependent on the way neutrons are slowed down and diffuse in the moderator.

Neutrons diffuse through a material as a result of being scattered by nuclei. Neutrons virtually never collide with each other because the neutron density is so much smaller than the atomic density. The treatment of neutron diffusion, which is a process similar to the diffusion of electrons in a metal, is too complicated to include in this course, and we shall therefore restrict ourselves to the pictorial representation in Figure 3.

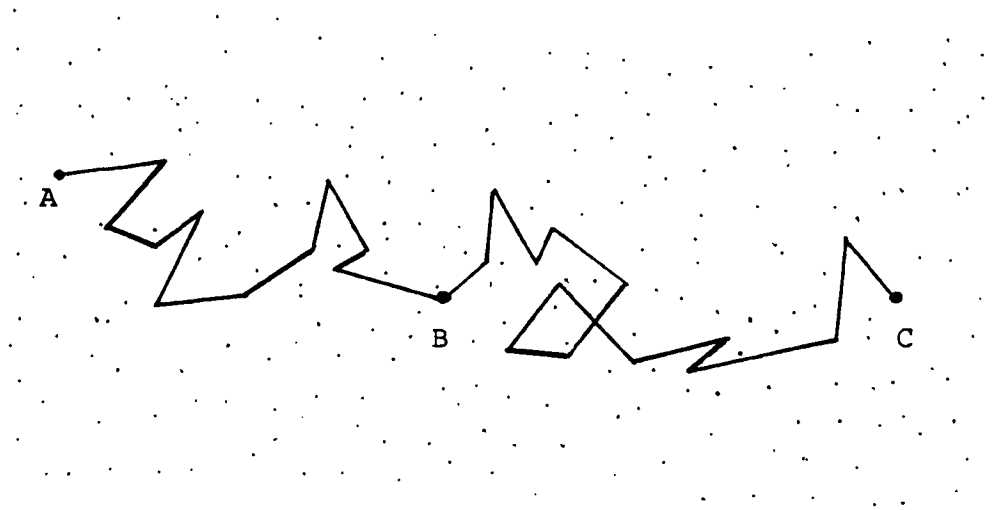

Figure 3

Neutron Diffusion In A Moderator

A fission neutron born at A is thermalized after several collisions and arrives at B. The average distance between A and B in a Candu reactor is about 25 cm. After slowing down the neutron diffuses to C where it is absorbed. The distance BC is about 30 cm. These are known as the mean "crow-flight" distances and are straight line displacements not total distance travelled.

The crow-flight slowing down distance determines the optimum distance between adjacent fuel channels. This spacing is called the *Lattice Pitch*. Figure 4 shows the approximate variation of  $k$  (the neutron multiplication factor), with lattice pitch.

Note that if the lattice pitch varies in either direction from its optimum value,  $k$  will decrease. If the pitch is increased we have extra moderator and some neutrons are being unnecessarily absorbed by the moderator before they reach the fuel. In this case the reactor is said to be overmoderated. If the pitch is decreased, we don't have enough moderator and some neutrons reach the fuel while still at resonance energy thus more are absorbed wastefully by the U-238 resonances. In this case the reactor is undermoderated.

All of Ontario Hydro's reactors are overmoderated. The reasons for this are physical rather than nuclear. The pressure tubes must have sufficient separation to allow the

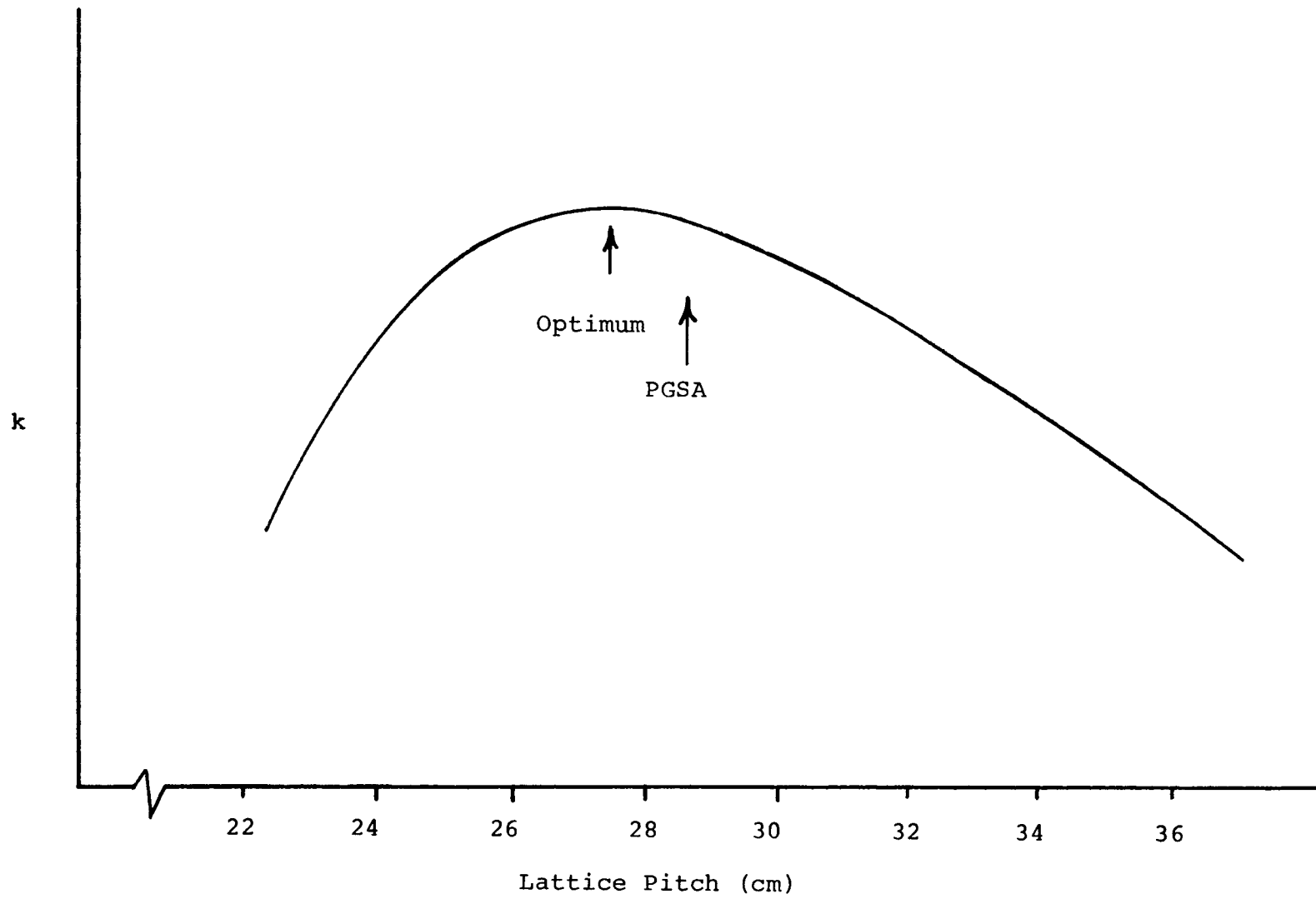

Lattice Pitch (cm)

Figure 4

$k$  vs Lattice Pitch

fueling machine access to the end fitting on either end of the fuel channel and the calandria tubes must have sufficient separation to allow space horizontally and vertically for control mechanism guide tubes.

Overmoderating our reactors by a small amount has very little effect as you can see by looking at the decrease in  $k$  on Figure 4 for the PGSA reactors.

The behaviour of  $k$  with Lattice Pitch has an additional benefit in that any significant accidental rearrangement of the reactor structure makes the reactor less reactive, for example, core disassembly in a melt down.

#### ASSIGNMENT

1. What is the practical significance of the fact that  $D_2O$  is poorer at slowing down neutrons than  $H_2O$ ?
2. Explain why changing the lattice pitch from the optimum value causes a decrease in reactivity. Why is this a safety feature?

J.E. Crist  
A. Broughton

## Nuclear Theory - Course 227

## NEUTRON MULTIPLICATION FACTOR AND REACTIVITY

In the previous lesson the neutron multiplication factor (k) was defined as:

$$k = \frac{\text{no. of neutrons in one generation}}{\text{no. of neutrons in the preceding generation}}$$

This definition is only valid if the neutron power is high enough that the effect of source neutrons (photoneutrons and spontaneous fission neutrons) may be ignored and if k itself is not changing. A more precise way to define k is as the product of six factors, each of which represents a possible fate for a member of the neutron population. Thus:

$$k = \epsilon p \eta f \Lambda_f \Lambda_t$$

Where:

$\epsilon$  (epsilon) = Fast Fission Factor. The factor by which the fast neutrons population increases due to fast fission.

$$\epsilon = \frac{\text{No. of neutrons from thermal fission} + \text{No. of neutrons from fast fission}}{\text{No. of neutrons from thermal fission}}$$

A typical value is about 1.03 for natural uranium fuel

p = Resonance Escape Probability. The probability that a neutron will not undergo resonance capture in U-238 while slowing down.

$$p = \frac{\text{No. of neutrons leaving resonance energy range}}{\text{No. of neutrons entering the resonance energy range}}$$

July 1979

A typical value is about 0.9 for natural uranium fuel.

$\eta$  (eta) = Reproduction Factor. The number of neutrons produced by thermal fission per neutron absorbed by the fuel.

$$\eta = \nu \frac{\Sigma_{\text{fuel}}^f}{\Sigma_{\text{a}}^{\text{fuel}}} = \nu \frac{\Sigma_{\text{fuel}}^f}{\Sigma_{\text{f}}^{\text{fuel}} + \Sigma_{\text{n},\gamma}^{\text{fuel}}}$$

A typical value is about 1.2 for natural uranium fuel.

$f$  = Thermal Utilization. The fraction of the thermal neutrons absorbed by the fuel compared to neutrons absorbed in the whole reactor.

$$f = \frac{\Sigma_{\text{a}}^{\text{fuel}}}{\Sigma_{\text{a}}^{\text{total reactor}}}$$

A typical value is about 0.95 for a CANDU reactor core.  
Note: Fuel must be defined the same way for both  $\eta$  &  $f$ .

$\Lambda_f$  = Fast Non-leakage Probability. The probability that a fast neutron won't leak out of the reactor. A typical value is about 0.995.

$\Lambda_t$  = Thermal Non-leakage probability. The probability that a thermal neutron won't leak out of the reactor. A typical value is about 0.98.

The first four factors, which depend only on the materials of construction, are frequently grouped together and called the multiplication factor for an infinite reactor ( $k_{\infty}$ ).

$$k_{\infty} = \epsilon \rho \eta f$$

This is normally referred to as the "four-factor formula".

The last two factors are leakage factors which depend on the size and shape (ie, the geometry) of the reactor. Figure 1 shows how each of the factor relates to the neutron life cycle.

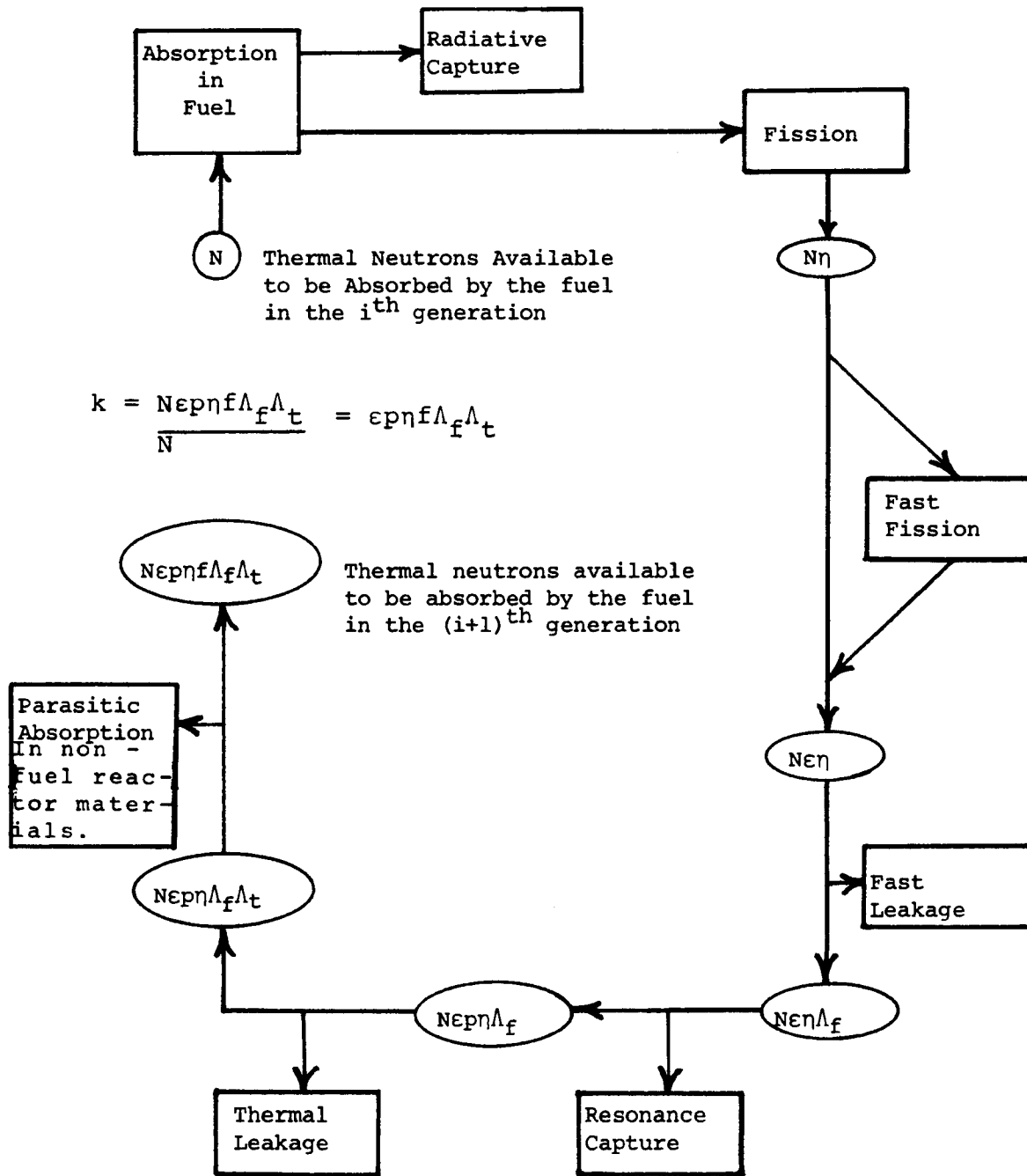

Neutron Life Cycle

Figure 1



A thermal neutron which is absorbed by the fuel may be absorbed by fissile material (U-235 or Pu-239) or by non-fissile material (Fission Products, U-238, etc). If it is absorbed by fissile material it may undergo radiative capture or cause fission. If it causes fission,  $\nu$  fast neutrons will be produced. The reproduction factor ( $\eta$ ) accounts for all of this. Thus for  $N$  thermal neutrons absorbed by the fuel  $N\eta$  fast neutrons are produced.

As U-238, Pu-239, and U-235 all have small but finite fission cross-sections for fast neutrons, the fast neutrons can cause additional fissioning to take place. This results in an increase ( $\approx 3\%$ ) in the fast neutron population. The fast fission factor ( $\epsilon$ ) accounts for this increase in the fast neutron population. Thus for  $N\eta$  fast neutrons from thermal fission we get  $\epsilon N\eta$  fast neutrons from fast and thermal fission.

The two factors  $\epsilon$  and  $\eta$  are essentially properties of the fuel and the magnitude of the product  $\epsilon\eta$  fixes the tolerable limits of the other factors which can be regarded as design variables. That is the product  $p\Lambda_f\Lambda_t \geq \frac{1}{\epsilon\eta}$ .

While slowing down the fast neutrons may reach the boundary of the reactor and leak out. To account for this reduction in the population we have the fast non-leakage probability ( $\Lambda_f$ ).

The fast neutrons may also suffer resonance capture while slowing through the resonance energy range. The resonance escape probability ( $p$ ) accounts for this. Thus for  $N\epsilon\eta$  fast neutrons starting the slowing down process  $N\epsilon\eta p\Lambda_f$  neutrons reach thermal energy.

A certain percentage of the thermal neutron population will diffuse to the boundary and leak out. We use the thermal non-leakage probability ( $\Lambda_{th}$ ) to account for this loss.

The remaining thermal neutrons will either be absorbed by the fuel or by the core material. The thermal utilization factor ( $f$ ) accounts for this. Thus for  $N\epsilon\eta p\Lambda_f\Lambda_{th}$  thermal neutrons,  $N\epsilon\eta p\Lambda_f\Lambda_{th}$  are absorbed by the fuel.

From Figure 1 you can see that if we divide the number of neutrons in the  $(i + 1)^{th}$  generation by the number in the  $i^{th}$  generation we have:

$$k = \frac{N\epsilon\eta p\Lambda_f\Lambda_{th}}{N} = \epsilon\eta p\Lambda_f\Lambda_{th}$$

When  $k = 1$  the reactor is said to be critical. If  $k$  is unity and the effects of source neutrons are negligible, neutron power will be constant in a critical reactor. It is important to realize that a reactor may be critical at any power level and that telling someone that a reactor is critical tells them nothing about the reactor's power output. By analogy; if I tell you that a car is not accelerating, do you know how fast it is going?

If we want to increase power we must make  $k$  greater than one by reducing the losses, with respect to fission, of neutrons. The reactor is then said to be supercritical. Power will continue to increase as long as  $k$  is maintained at a value greater than one.

To reduce power we must increase the losses of neutrons thus making  $k$  less than one. The reactor then is said to be subcritical and power will decrease until the source neutrons become significant. (This point will be covered in detail in lesson 227.00-9.)

### Reactivity

A reactor is critical when  $k = 1$ . The factor that determines how subcritical or supercritical a reactor may be, is the amount by which  $k$  differs from 1.

A quantity called reactivity, is used to describe changes in  $k$  which are called reactivity changes. Reactivity is defined as:

$$\frac{k - 1}{k}$$

For values of  $k$  close to 1 (eg, 0.98 to 1.02) which easily encompasses our normal operating range.

Reactivity may be approximated as

$$\Delta k = k - 1$$

This is the accepted meaning of reactivity in Hydro.

The reactivity changes that are made for normal reactor control are always quite small, and they are measured in a unit called the milli- $k$  or mk. (This is not strictly a unit but is a fraction, 1 mk is the same as 0.1%, ie, 0.001).

For Example:

$$\begin{aligned} k &= 1.002 \\ \Delta k &= k - 1 \\ &= 1.002 - 1 \\ &= 0.002 \text{ or } 2 \text{ mk} \end{aligned}$$

A typical CANDU reactivity control system such as the liquid control zone at Bruce and Pickering have a range of about 6 mk.

ASSIGNMENT

1. Put your text and your notes away. Now, write the six factor formula, define each of the terms, and sketch the neutron life cycle with the terms used correctly.
2. Calculate the exact value of reactivity for  $k = 0.95$ .
3. Calculate each of the six factors for the neutron life cycle shown below.

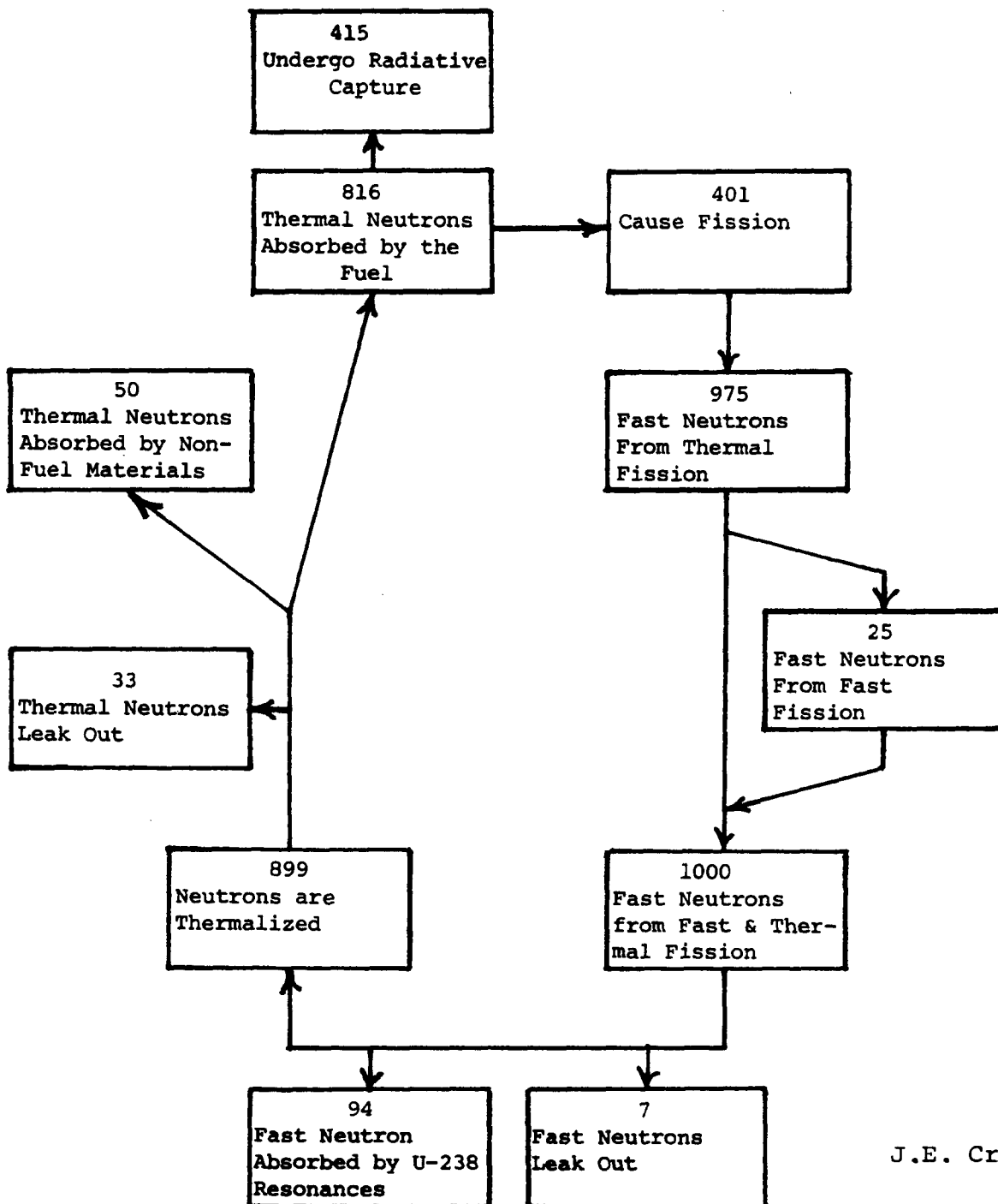

## Nuclear Theory - Course 227

## NEUTRON FLUX DISTRIBUTION

From neutron diffusion theory it is possible to derive the steady state flux distribution in a reactor. Since the flux is not normally the same everywhere in a reactor, its distribution or shape is obviously of importance because it will determine the distribution of power generated in the core. Generally the flux has a maximum at the centre of the core, and drops off to zero outside the moderator volume because there is no thermal neutron source there.

In a cylindrical reactor, shown below, there are two directions along which the flux distribution is considered. These are the axial direction,  $\phi_z$ , and the radial direction,  $\phi_r$ , from the centre of the reactor.

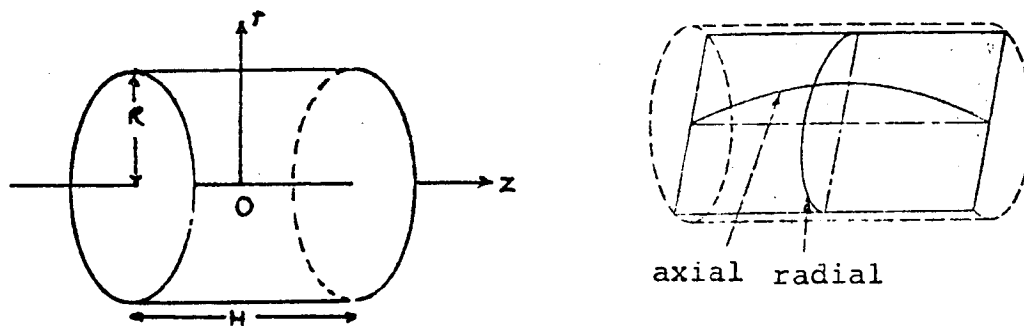

Figure 1

Neutron Flux Distribution in a Cylinder

The thermal neutron flux  $\phi(r, z)$  at a point  $(r, z)$  in the cylinder is given by:

$$\phi(r, z) = \phi_m J_0 \left( \frac{2.405r}{R} \right) \cos \left( \frac{\pi z}{H} \right)$$

where  $\phi_m$  is the maximum flux. It occurs at the point 0.  $J_0(2.405 r/R)$  gives the radial flux distribution. It is a special function, namely a zero order Bessel function. Fortunately it is only marginally different from a cosine function.

Unfortunately the ratio of the average flux ( $\phi_{avg}$ ) to the maximum flux ( $\phi_{max}$ ) is only 27.5%. The total power output of the reactor depends on  $\phi_{avg}$ .

One way of increasing the average flux, hence the power, is to increase the maximum flux,  $\phi_{\max}$ . However,  $\phi_{\max}$  is normally limited by the maximum fuel heat rating, and this will be reached first at the centre of the reactor. One way in which the rest of the fuel can be made to contribute "its share", is to deliberately flatten the flux distribution over part of the reactor. For example, if the average flux can be increased from 27.5% to 55% of the maximum, the same reactor can supply twice the power.

The justification for flux flattening is therefore an economic one. We will discuss flux flattening later in this lesson but first we need to look at the loss of neutrons due to leakage from the reactor.

### Neutron Leakage

Knowing that Candu fuel is used in a reactor, let me raise the question "Can a single fuel bundle be made critical in a vat of heavy water?" The answer is no, because too many of the fission neutrons escape from the fuel never to return (ie, the non-leakage probabilities  $\Lambda_f$  and  $\Lambda_{th}$  are too low). Now let us assemble more and more fuel bundles, properly spaced, until the reactor is critical. The minimum size of this assembly of fuel and moderator which will yield a self-sustaining chain reaction is called the critical size. For fixed reactor materials and spacing, the critical size is determined by:

- 1) the shape of the reactor
- 2) what happens to a neutron at the reactor boundary.

To illustrate the importance of shape, assume that eighteen fuel bundles assembled as shown below, with a  $D_2O$  moderator and optimum lattice pitch (25.5 cm), make a critical mass.

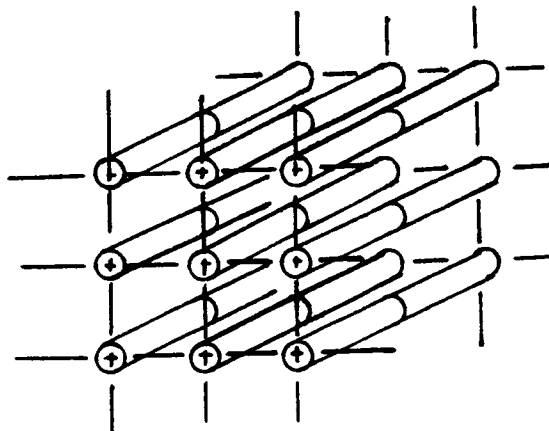

Figure 2

Now ask yourself "Would the same eighteen fuel bundles be critical in a single tube surrounded by a D<sub>2</sub>O moderator?"

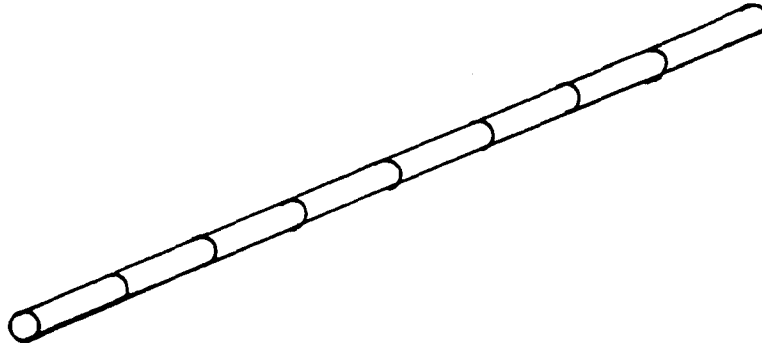

Figure 3

The answer is again no, because the leakage is far too great.

Both the effects of size and shape can be combined by observing that the smaller the surface area of the core per unit volume of the core, the smaller will be the leakage. Based on this observation you would build a large spherical reactor (see 327.00-1).

The astute mechanical designers amongst you will recognize that a spherical reactor would be very difficult (ie, expensive) to construct, therefore, we use the next best shape - a cylinder in which the height is approximately equal to the diameter. The size of the reactor is essentially determined by how large a turbine-generator unit the station is going to have.

All our reactors except NPD are quite large and thus have minimal leakage (Pickering and Bruce,  $D \approx H \approx 6$  m: NPD,  $D \approx H \approx 3.5$  m). Neutron leakage can be further reduced by surrounding the core with a substance which scatters or reflects neutrons back into the core. Such a substance is known as a *reflector*. An additional benefit of using a reflector is that it produces a flatter flux distribution, and therefore better fuel utilization.

#### The Function of the Reflector

Figure 4 on the next page shows the function of a reflector diagrammatically. Figure 4(a) shows a "bare" core with many neutrons escaping. In Figure 4(b) a substance has been placed around the core to reflect most of the neutrons back into the core.

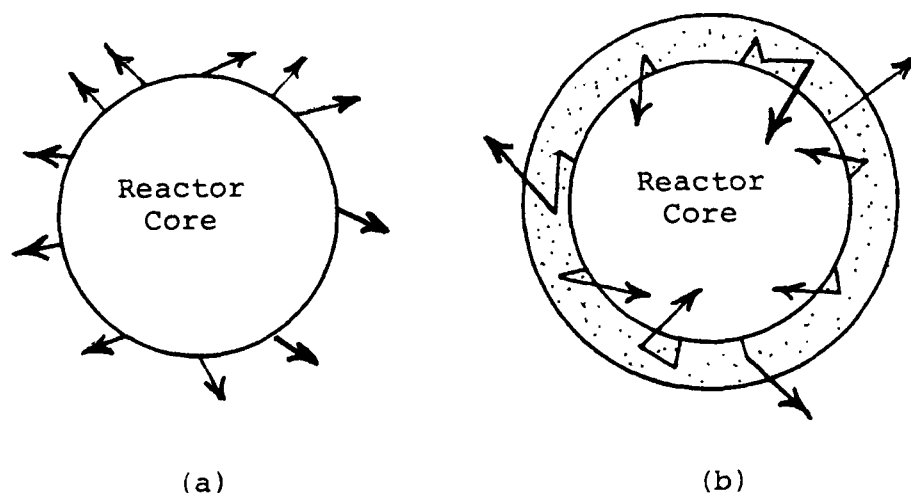

Figure 4

The Function of the Reflector

It is evident that, with the reflector, more neutrons are available for fission because the leakage is smaller. Therefore, the core size does not have to be increased as much in order for the reactor to go critical. That is, the critical size of a reflected core is smaller than that of a bare core. Alternatively, if the size of the core is kept the same, higher fuel burnups can be achieved with consequent reduction in fuel costs.

Reflector Properties

Neutrons are reflected back into the core as a result of scatterings with reflector nuclei; hence, a material with a high scattering cross-section is desirable. It is equally desirable that the reflector not absorb too many neutrons (low absorption cross-section). These are the same things that we desire from a moderator.

For this reason, the reflector usually is just an extension of the moderator (approximately 70 cm for our large reactors). This has the advantage of (a) simplifying the design of the reactor vessel and (b) obviating the need for a separate reflector system.

### The Effects of Adding a Reflector

The effects of placing a reflector around the core can be summarized as follows:

1. The thermal flux is "flattened" radially, ie, the ratio of average flux to maximum flux is increased. This is illustrated in Figure 5. The hump in the curve is due to the fact that fast neutrons escape into the reflector and are thermalized there. They are not as likely to be absorbed there as they are in the core.

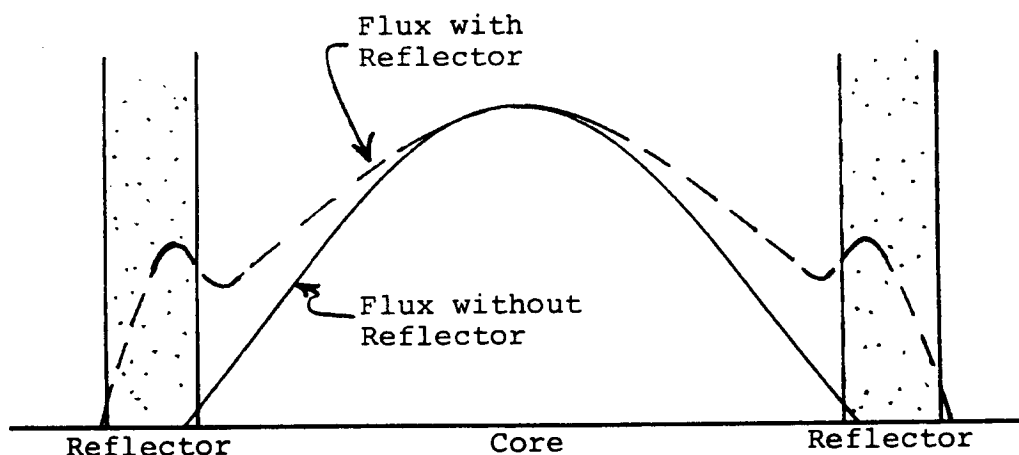

Figure 5

### The Effect of a Reflector on the Thermal Flux Distribution

2. Because of the higher flux at the edge of the core, there is much better utilization of fuel in the outer regions. This fuel, in the outer regions of the core, now contributes much more to the total power production.
3. The neutrons reflected back into the core are now available for fission. This means that the minimum critical size of the reactor is reduced. Alternatively, if the core size is maintained, the reflector makes additional reactivity available for fuel burnup.

### Flux Flattening

For maximum power output from a given reactor, it is desirable that each fuel bundle contribute equally to the total power output. As we have shown, in an unreflected (bare) reactor the average flux ( $\phi_{avg}$ ) is only 27.5% of the maximum flux ( $\phi_{max}$ ). Thus the average fuel bundle is producing only one



quarter of the power it could safely produce (assuming the bundle which is exposed to the peak flux is producing the maximum power it can safely produce).

To improve this situation we attempt to flatten the flux, ie, reduce the peak to average flux ratio:

$$\left(\frac{\phi_{\text{avg}}}{\phi_{\text{max}}}\right).$$

For our reactors four methods of flux flattening are used:

- 1) Reflector (previously discussed)
- 2) Bi-directional refuelling
- 3) Adjuster rods
- 4) Differential burnup.

#### Bi-directional Refuelling

If adjacent fuel channels are fuelled in opposite directions, as they are in our reactors, an automatic flux flattening arises in the axial direction. The effect is illustrated in Figure 6.

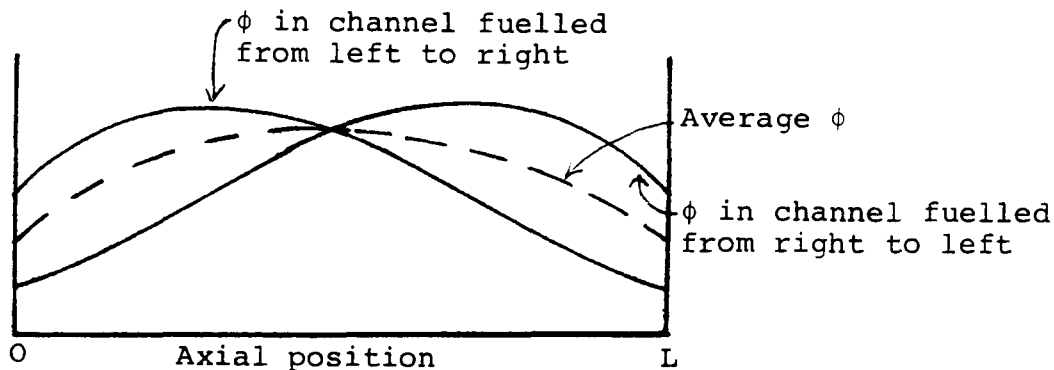

Figure 6

#### Effect of Bi-Directional Refueling

The effect is due to the fact that the newer fuel (at the input end of the channel) will generate a higher flux than the highly burned up fuel at the exit end. How much flattening is obtained in this way actually depends on how many bundles are replaced during refueling. From the point of flux flattening,

the fewer the better; however, other considerations (discussed in Reactor, Boilers & Auxiliaries, 133.60-2) largely determine the number of bundles replaced. Even with the present refueling schemes (8 or 10 out of 12 bundles at Pickering and 8 or 10 out of 13 at Bruce) some flux flattening is obtained. Additionally, bi-directional refueling prevents the development of the undesirable flux distribution which would result from uni-directional, partial channel, refueling (shown in Figure 7).

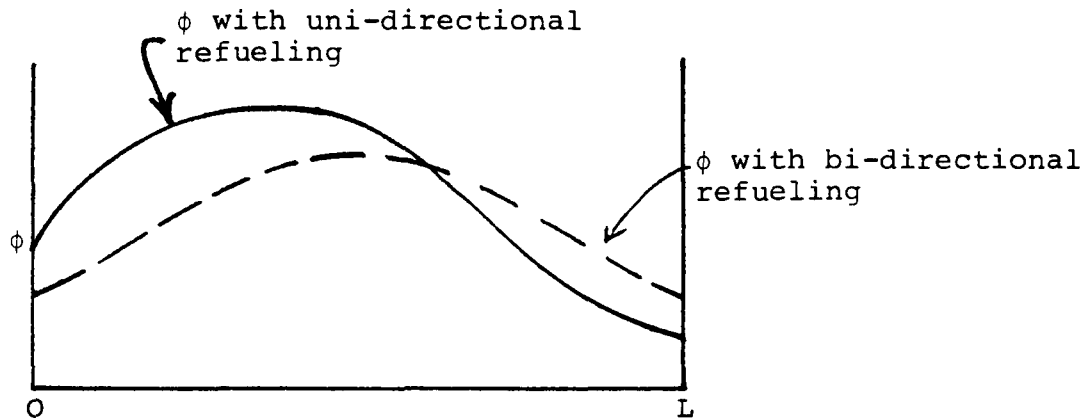

Figure 7

Effect of Unidirectional Fueling

Adjuster Rods

Adjusters are rods of a neutron absorbing material which are inserted into the central regions of the reactor to suppress the flux peak which normally occurs there. The name adjusters comes from their function (ie, adjusting flux) and they should not be confused with control absorbers. Adjusters affect both the radial and axial flux. Figure 8 shows the radial flux distribution in a reactor with adjusters and one without. Note that both flux curves are drawn with the same maximum flux; thus, the reactor with adjusters gives a higher power output for the same maximum flux.

The Pickering-A reactors use 18 adjuster rods (shown in Figure 9) constructed of Cobalt. When Cobalt absorbs a neutron it becomes Co-60 ( ${}_{27}\text{Co}^{59} + {}_0\text{n}^1 \rightarrow {}_{27}\text{Co}^{60} + \gamma$ ). The adjusters are replaced periodically and the Co-60 is processed and marketed by AECL. The designs of Bruce-B, Pickering-B, and Darlington include the use of 21 stainless steel adjuster rods.

Inasmuch as adjuster rods are normally inserted in the reactor at full power, they represent a negative reactivity contribution. To overcome this we must reduce the fuel burnup by approximately 10%. This is reflected in slightly higher fuel costs.

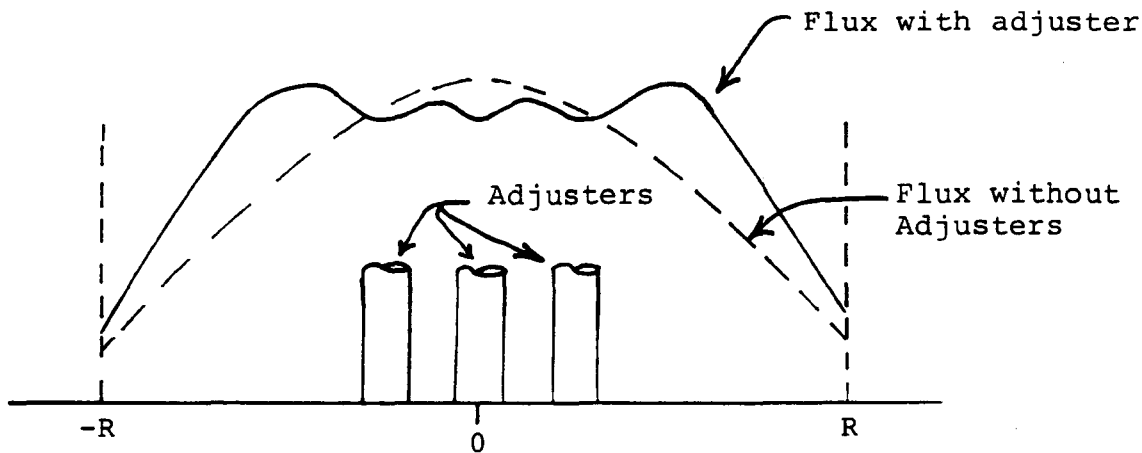

Figure 8  
Effect of Adjuster Rods

In addition to flattening the flux, adjuster rods are withdrawn to add positive reactivity for Xenon override.

#### Differential Burnup

Differential burnup is a method of flux flattening used at Douglas Point and Bruce-A which avoids incurring the fuel burnup loss experienced due to adjusters. For this purpose the reactor is divided into two regions radially as shown in Figure 9.

The fuel in Zone I is allowed to burnout approximately 1.5 times as much as the fuel in Zone II. With more highly burned out fuel in the centre of the core there is less fissioning taking place, hence lower flux. The effect is shown in Figure 10. Note that differential fueling gives flux flattening only in the radial direction.

Table I lists the present Ontario Hydro Reactors, the methods of flux flattening used and the resultant peak to average flux ratios.

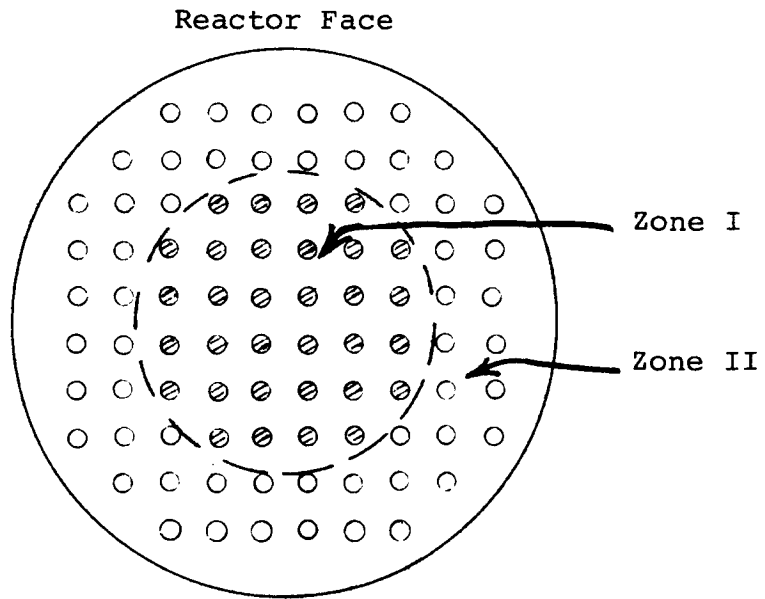

Figure 9  
Differential Fueling Zones

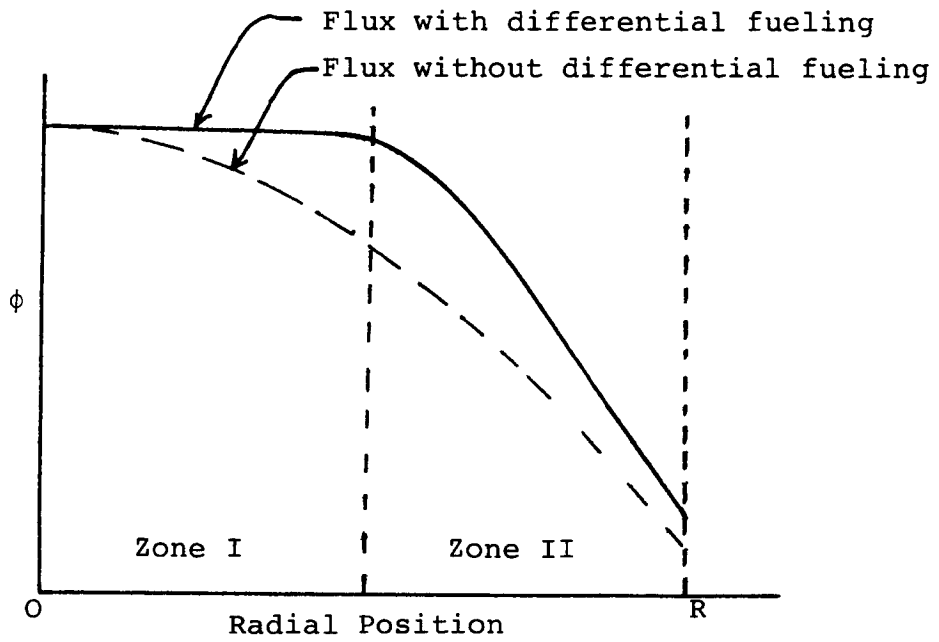

Figure 10  
Effect of Differential Fueling

TABLE I

	Reflector	Bi-Directional Fuelling	Adjusters	Differential Burnup	$\frac{\phi_{avg}}{\phi_{max}}$
NPD	axial & radial	✓			42%
Douglas Point	radial	✓		✓	50%
Pickering-A	radial	✓	✓		57%
Pickering-B	radial	✓	✓		60%
Bruce-A	radial	✓		✓	~59%
Bruce-B	radial	✓	✓		~60%
Darlington	radial	✓	✓	✓	~60%

The expression:

$$P = \frac{\bar{\phi} \cdot M}{3 \times 10^{12}}$$

relates the total power output P (in MW thermal) to the total mass of uranium fuel M (in Mg U) for an average thermal flux  $\bar{\phi}$ . You will appreciate that increasing  $\bar{\phi}$  without increasing the maximum flux  $\phi_m$  has enormous economic benefits. For instance, the first four Pickering units cost 765 million dollars. Without any flux flattening at all,  $\bar{\phi}/\phi_m$  would have been around 27%, ie, for roughly the same investment\* we would have got less than half the installed capacity.

---

\*You wouldn't have had to pay for the D<sub>2</sub>O reflector and the adjuster rods, and any loss in fuel burnup not off-set by cobalt-60 production.

ASSIGNMENT

1. Using sketches explain why a reflector is more important at NPD than it is at Pickering.
2. Why do we flatten the flux in Ontario Hydro's reactors?
3. Explain how each of the methods of flux flattening works.

J.E. Crist

## Nuclear Theory - Course 227

## EFFECT OF FUEL BURNUP

The changes in the composition of the fuel as it is depleted give rise to a number of effects which may be described under the following headings:

- 1) Long Term Reactivity Effects
- 2) Reactor Kinetics Effects
- 3) Neutron Flux Distribution Effects

Burnup Units

Before discussing the effects of fuel burnup we must first look at the commonly used units. Burnup is expressed either in terms of:

- (a) the total heat energy extracted per unit weight of fuel, preferably expressed in MWh/kgU.  
(Note: MWh is thermal energy not electrical energy.)
- (b) the total neutron exposure (flux x time), of the fuel, normally expressed in neutrons/kilobarn (n/kb). This is a convenient but illogically named unit arrived at by multiplying flux  $\frac{\text{neutron} \cdot \text{cm}}{\text{cm}^2 \cdot \text{s}}$

by time (s) and getting units of neutrons/cm<sup>2</sup>.  
Therefore:

$$1 \text{ n/kb} = \frac{1 \text{ neutron}}{10^3 \times 10^{-24} \text{ cm}^2} = 10^{21} \frac{\text{neutrons}}{\text{cm}^2}$$

This is more properly expressed as  $10^{21} \frac{\text{neutron cm}}{\text{cm}^3}$ ,

the total neutron track length per unit volume.

Long Term Reactivity Effects

The composition of the fuel will change quite significantly during its life in the reactor. There are two predominant effects: the burnup of fissile U-235 and the conversion of non-fissile U-238 into fissile plutonium.

The rate at which these occur depends on the neutron flux, because the rate  $\frac{dN}{dt}$  of neutron capture by nuclides

per unit volume, is given by

$$\frac{dN}{dt} = N\sigma_a\phi$$

Where  $N$  is the number of nuclides/unit volume.  
 $\sigma_a$  is the absorption cross-section per nuclide.  
 $\phi$  is the neutron flux.

For U-235 exposed to a typical flux of  $10^{14} \frac{\text{neutron}\cdot\text{cm}}{\text{cm}^3\cdot\text{s}}$

it takes about four months to burnout half of the U-235 initially present. Fortunately the burnout of U-235 is offset by the conversion of U-238 to fissile Pu-239 by the following scheme:

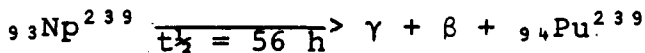
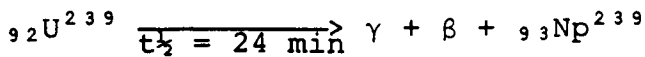
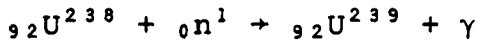

The Pu-239 that is produced will eventually build up to equilibrium when its rate of production will be equal to its rate of removal ( $\sigma_f = 742\text{b}$ ,  $\sigma_n, \gamma = 271\text{b}$ ). This will be at an irradiation of about 3 n/kb. The Pu-240 formed by neutron capture has properties very similar to U-238, but if it captures another neutron it will form fissile Pu-241 ( $\sigma_f = 1007\text{b}$ ,  $\sigma_n, \gamma = 368\text{b}$ ).

Therefore after a long period of reactor operation, power will be produced from fission of U-235, Pu-239 and Pu-241.

Figure 1 shows the concentration of these nuclides as a function of total flux exposure. Table I presents the same data using both burnup units. Note that flux exposure and energy extracted are not linearly related due to the variation in the fission cross section of the fuel.

Of equal significance to overall long term reactivity is the buildup of Pu-240 and neutron absorbing fission products (other than Xenon which will be considered separately). Figure 2 shows the approximate reactivity variation due to the major factors just discussed.



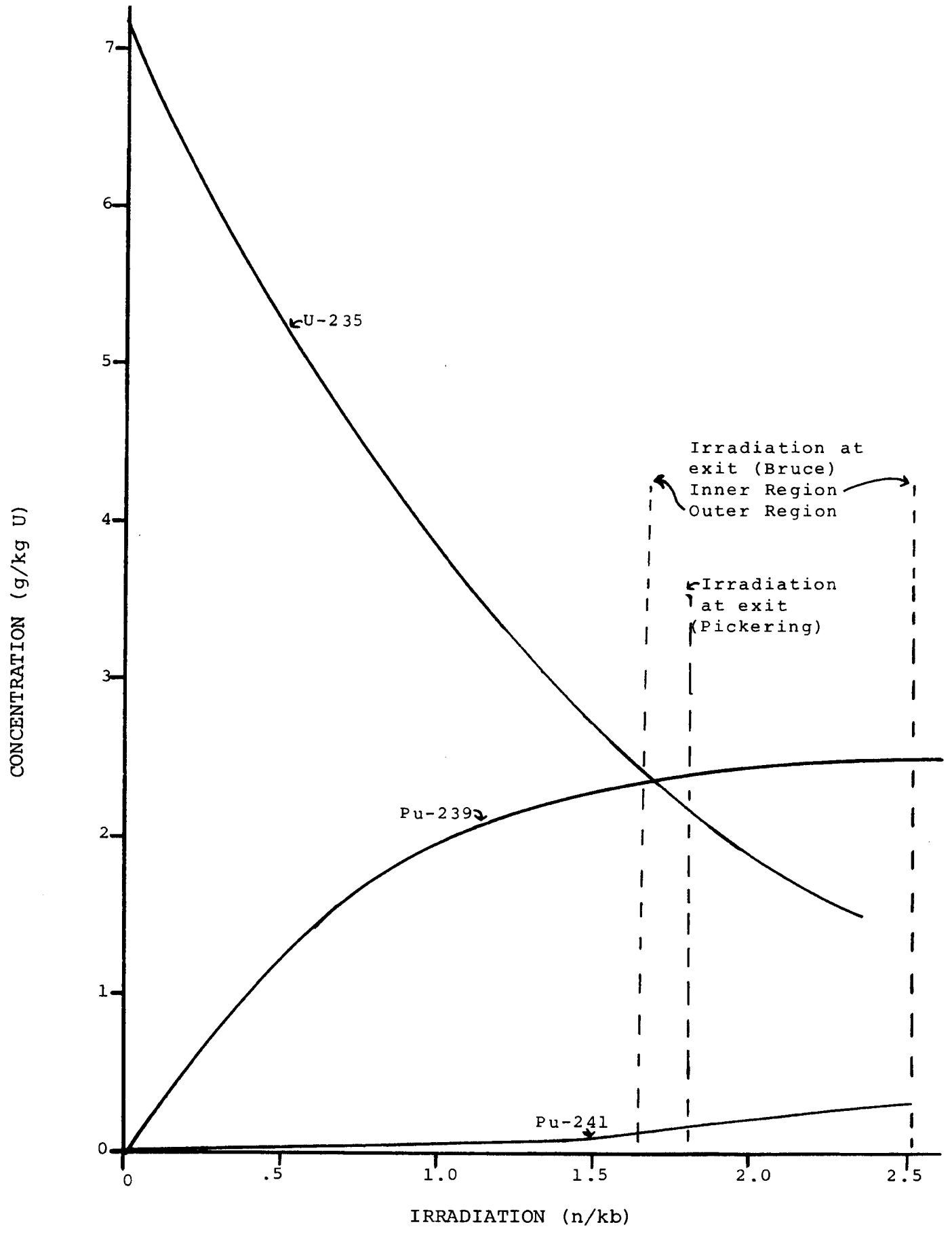

FIGURE 1

TABLE 1Burnup Data\*

n/kb	MWh/kgU	U-235 (g/kgU)	Pu-239 (g/kgU)	Pu-241 (g/kgU)
0	0	7.20	0	0
0.2	19	6.37	0.60	0.002
0.4	39	5.62	1.10	0.009
0.6	59	4.90	1.48	0.025
0.8	79	4.30	1.77	0.049
1.0	100	3.76	1.98	0.078
1.2	120	3.32	2.14	0.107
1.4	140	2.90	2.25	0.145
1.6	159	2.56	2.33	0.177
1.8	179	2.26	2.39	0.211
2.0	198	1.98	2.43	0.245
2.2	216	1.74	2.46	0.278
2.4	235	1.54	2.48	0.309
2.6	253	1.35	2.49	0.338
2.8	271	1.18	2.50	0.366
3.0	289	1.03	2.50	0.393

\* The values shown in this table strictly speaking apply only to the Pickering reactors, but they will be correct to within a percent or so for all natural uranium, D<sub>2</sub>O moderated reactors.

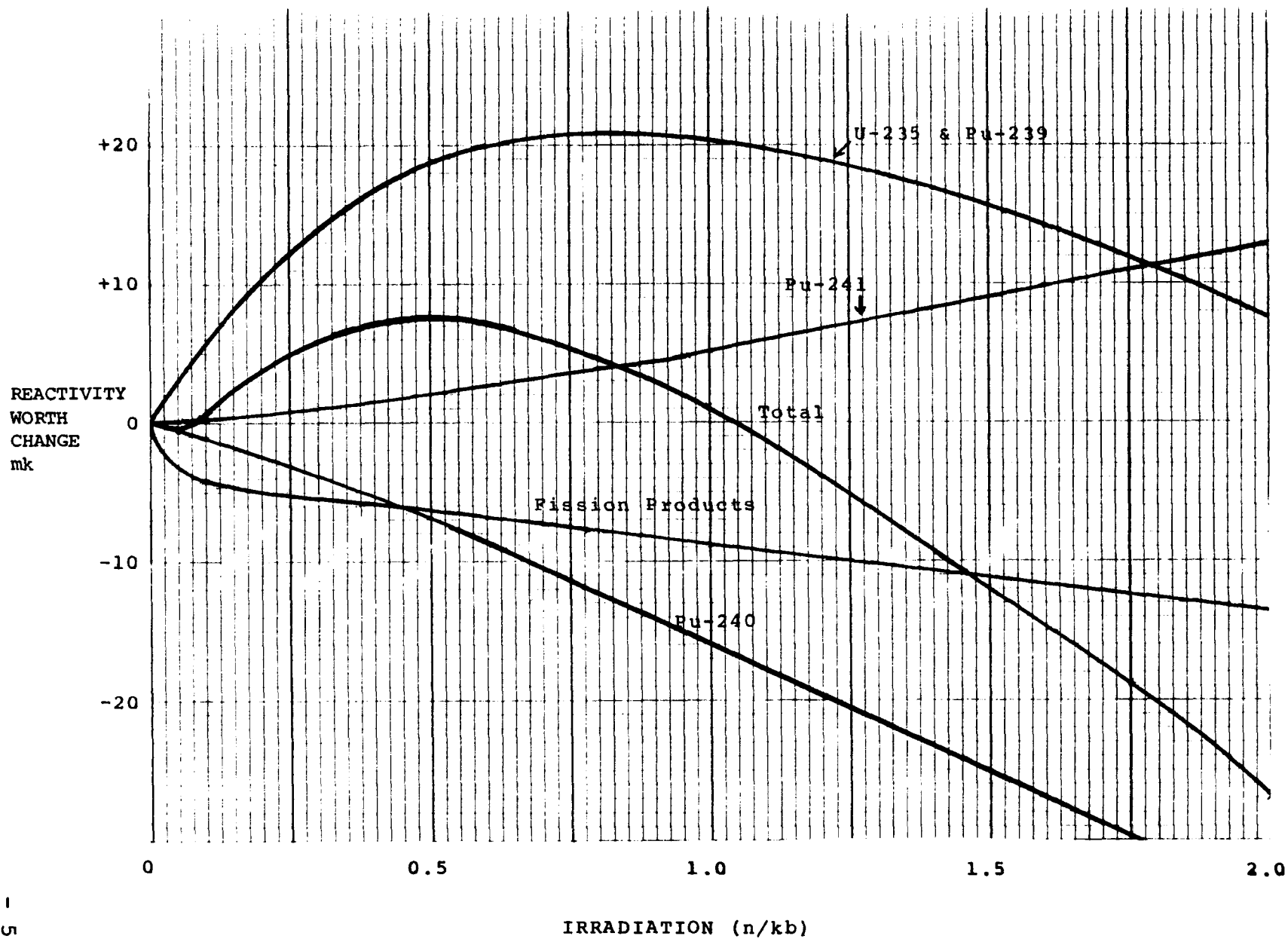

FIGURE 2

Initially the burnup of U-235 and its replacement by a smaller number of Pu-239 nuclei ( 8 Pu-239 atoms created for each 10 U-235 atoms burned up) leads to an increase in reactivity. This is due to the higher fission cross section of Pu-239. ( $\sigma_f$  (Pu-239) = 742b;  $\sigma_f$  (U-235) = 580b).

At higher irradiations the U-235 is still being removed, but the buildup of Pu-239 becomes less rapid as it approaches its equilibrium level when the production of Pu-239 will equal the removal due to absorption. Consequently at high irradiations the reduction in the number of fissile nuclei causes a reduction in reactivity.

The build up of Pu-240 produces a large negative reactivity contribution due to significant neutron absorption ( $\sigma_a = 280$  b). This is partially offset by the buildup of fissile Pu-241. There is an initial rapid decrease of fission product reactivity due mainly to Sm-149 ( $\sigma_a = 41,800$  b) which reaches an equilibrium after about 300 hours of operation. This rapid decrease is followed by a nearly linear decrease due to the continuing creation of mildly neutron absorbing fission products.

It is also useful to examine how the four factors of the infinite multiplication factor  $k_\infty$  vary with burnup.

Figure 3 is a graph of the predicted variation of  $k_\infty$  and the four factors taken from the Bruce Design Manual. First note that neither the fast fission factor ( $\epsilon$ ) nor the resonance escape probability ( $p$ ) show any significant variation and can be assumed to be constant with respect to fuel burnup. This is due to the fact that most fast fission and resonance capture takes place in U-238 which constitutes ~99% of the fuel whether it is fresh or equilibrium fuel.

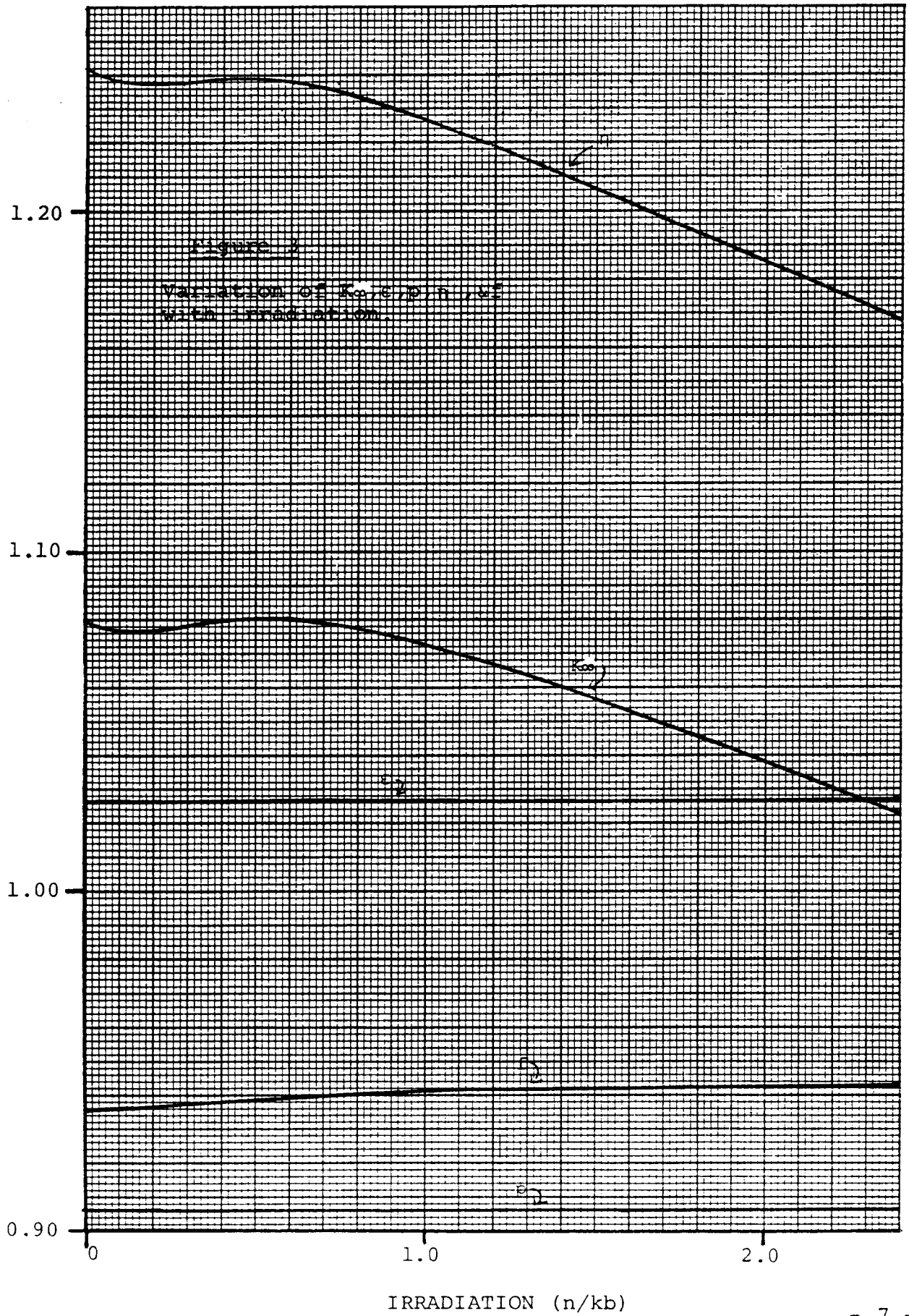

The most important variation is in the reproduction factor ( $\eta$ ). Recall from lesson 227.00-5 that:

$$\eta = \nu \frac{\sum_{\text{fuel}} f}{\sum_{\text{fuel}} a}$$

While all of the parameters in  $\eta$  change with irradiation, the most important variations are:

1. Initial decrease due to Sm-149
2. Increase (to about 0.5 n/kb) - due to the buildup of Pu-239
3. Continuing decrease after 0.5 n/kb -due to burnout of U-235 and the buildup of Pu-240 and fission products.

The thermal utilization ( $f$ ) increases slightly due to increasing absorption in the fuel relative to the core structural materials. (Note that the buildup of Pu-239, Pu-240, Pu-241, and fissions products all lead to increased absorption by the fuel.)

Clearly at some point in time the value of  $k$  will go below one and we no longer have a useful reactor. Normally we target our reactors to operate at full power with small amounts of positive reactivity (typically  $\sim 5$  mk) available in addition to the Xenon override capability. Figure 4 is a plot of the actual excess reactivity at Pickering unit #1 for the initial fuel charge.

After  $\sim 180$  full power days daily onpower refueling was started to maintain the target reactivity. At this point in time the reactor is said to be at an equilibrium fuel condition. From this point onward refuelling takes place on a daily basis at a rate equal to the burnout rate; somewhere between 8 and 18 bundles per day. Prior to this the reactor is said to be in the fresh fuel condition. (Note: When speaking of the entire reactor we refer to fresh or equilibrium fuel, when referring to an individual fuel bundle it is either fresh or irradiated.

EXCESS  
REACTIVITY,  
mk

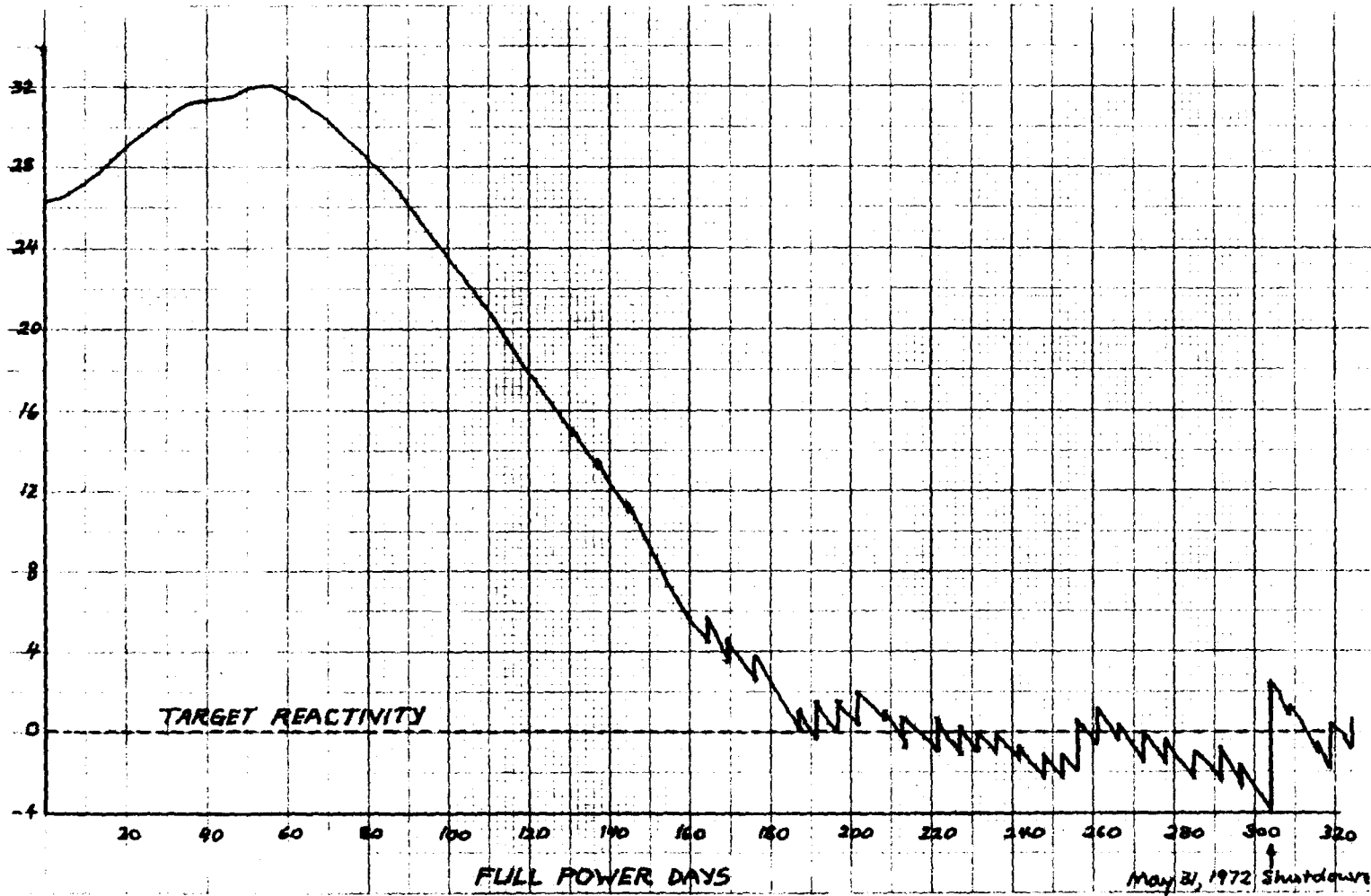

Reactivity as a Function of Burnup for Pickering Unit #1

227.00-7

FIGURE 4

### Reactor Kinetics Effects

The main effect on reactor kinetics is the change in the delayed neutron fraction ( $\beta$ ) with fuel burnup. Recall from lesson 227.00-2 that  $\beta(\text{U-235}) = 0.65\%$  and  $\beta(\text{Pu-239}) = 0.21\%$ . The importance of this change will become apparent in the lesson on Reactor Kinetics.

### Neutron Flux Distribution Effects

As discussed in the previous lesson both bidirectional refuelling and differential fuelling are useful for flux flattening due to the different characteristics of fresh and irradiated fuel.

### Fuel Management Calculations

The Fuel Engineer on the station is responsible for ensuring that as far as possible, the optimum fuel cycle is used.

In other words, that maximum reactor power be maintained with minimum fuel cost.

Various computer programs exist which are capable of following the histories of the bundles in the core. For example, such programs calculate the expected axial and radial power distributions, the burnup of each bundle in the core and the excess reactivity available. The validity of these calculations can be checked by comparing the power distributions put out by the program with those obtained from the flow rates and temperature increases ( $\Delta T$ ) in the various channels. If there are large discrepancies, the physics data of the program is modified by intelligent guesses until eventually the agreement between theory and practice is close enough.

The Fuel Engineer uses the output of such a program (typically this might be run monthly) to help him decide which channels to fuel when. Since the core is usually divided into a number of annular zones of roughly equal ratings, (eg, there are 8 such zones at Pickering), the fuelling rates per zone can easily be derived. Even so, no rigid fuelling pattern is used; the following criteria would have to be considered.

- (1) Discharge of highest burnup fuel (this information is obtained from the program).
- (2) High reactivity gain per channel fuelling (mainly intuitive).



- (3) No fuelling in high temperature areas if derating is likely to be necessary (the reactor control computer will print out a temperature matrix)
- (4) Symmetry
- (5) Equal numbers fuelled per reactor quadrant (Douglas Point) or per liquid control zone (Pickering & Bruce)
- (6) Alternate East and West fuelling.
- (7) Effect on neighbouring channels.
- (8) Experimental bundles.
- (9) Priority must be given to channels known to contain failed fuel.

After a channel has been fuelled, the corresponding changes in bundle positions will have to be input for the next run of the computer program. If the axial flux distribution in the reactor is fairly flat, it might well be expedient to fuel in so-called 8 or 10 bundle shifts. Figure 5 shows the changes in bundle positions for an 8 bundle shift at Pickering.

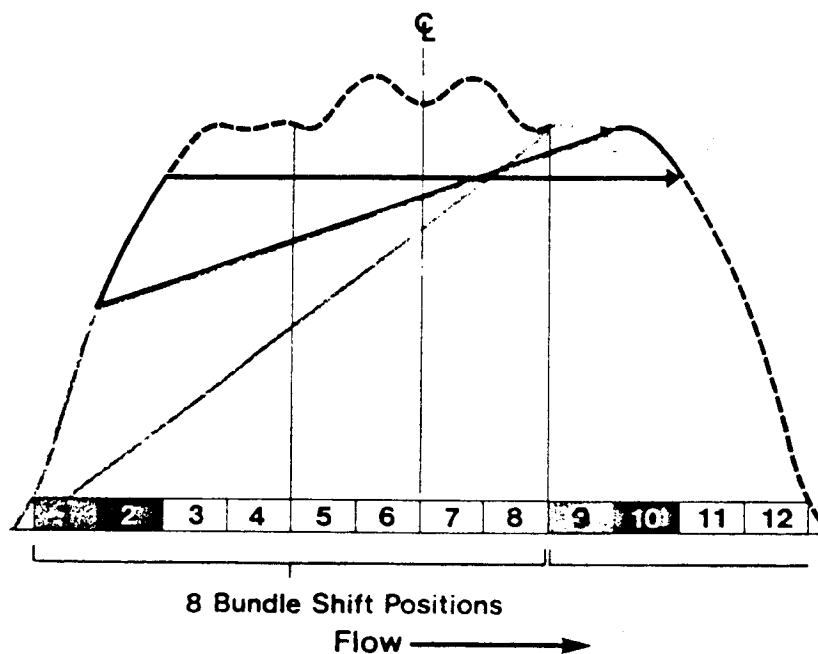

Pickering Axial Flux Profile

FIGURE 5

At Pickering for example, the adequacy of the fuelling program is assessed with the following guidelines:

- (1) Reactivity variations within normal range liquid zone level control.
- (2) Maximum channel outlet temperature well below first temperature alarm, and a minimum number of channels above a specified power level.
- (3) Minimum flux tilt, ie, zone levels similar.
- (4) Channel burnup evenly distributed within each annular zone - no significant over-irradiation of fuel.

We have control over items 2, 3 and 4 but for item 1 we are at the mercy of fuelling machine performance.

ASSIGNMENT

1. Explain (using appropriate formulas) the formation of Pu-239 & Pu-241 in a CANDU reactor.
2. Explain how and why the reproduction factor ( $\eta$ ) changes from fresh to equilibrium fuel in a CANDU reactor.
3. Could the state of the fuel (ie, fresh or equilibrium) make any difference in the ability to override Xenon? Explain your answer.
4. Using Figure 1 calculate the total fissile content of the fuel at exit from a Pickering reactor as a percentage of the initial fissile content. Inasmuch as the percentage you have calculated is rather high, explain why the fuel isn't left in the reactor longer.

J.E. Crist

## Nuclear Theory - Course 227

## CHANGES IN REACTOR POWER WITH TIME

Reactor kinetics is the study of how neutron power changes with time. As a preface to this discussion it must be recognized that neutron density ( $n$ ), neutron flux ( $\phi$ ), and neutron power ( $P$ ) are all related by physical or design constants such that they all behave in a similar manner. Their relationships are:

$$P = EV\Sigma_f\phi$$

$$\phi = nv$$

where:

$$P = \text{neutron power}$$

$$E = \text{energy released per fission}$$

$$\Sigma_f = \text{the macroscopic fission cross section}$$

$$\phi = \text{neutron flux}$$

$$V = \text{volume of the reactor}$$

$$n = \text{neutron density}$$

$$v = \text{average neutron velocity}$$

Prompt Kinetics

First we shall examine the behaviour of a reactor without delayed neutrons. The change of the neutron density in one generation is:

$$\Delta n = kn - n$$

where:

$$kn = \text{the neutrons in one generation}$$

$$n = \text{the neutrons in the preceding generation}$$

$$k = \text{neutron multiplication factor}$$

The time period over which this takes place ( $\Delta t$ ) is one neutron lifetime ( $\ell$ ).

Thus:

$$\frac{\Delta n}{\Delta t} = \frac{kn - n}{\ell}$$

or:

$$\frac{dn}{dt} = \frac{kn - n}{\ell} = \frac{n}{\ell} (k - 1) \times \frac{k}{k}$$

$$\frac{dn}{dt} = \frac{nk}{\ell} \frac{k-1}{k}$$

Recall that:

$$\frac{k-1}{k} = \Delta k$$

Normally  $k$  is very close to one so that:

$$\frac{\ell}{k} \approx \ell$$

We can now rewrite the equation as:

$$\frac{dn}{dt} = \frac{n}{\ell} \Delta k$$

The solution to this equation is:

$$n(t) = n_0 e^{\frac{\Delta k t}{\ell}}$$

where:

$$n_0 = \text{original neutron density}$$

Since both neutron flux and neutron power behave in a similar manner we can write:

$$P(t) = P_0 e^{\frac{\Delta k t}{\ell}} \quad (1)$$

Equation (1) shows that power changes exponentially with time and that the rate of change of power depends on the reactivity ( $\Delta k$ ) and the neutron lifetime ( $\ell$ ).

### Reactor Period

In operating reactors it is convenient to have an indication of how long it takes for power to change by a given amount (e.g. how long it takes for power to double or increase by a certain percentage). The most common measure in Candu reactor is how long it takes power to increase by a factor of  $e^*$ . This time interval is called the reactor period  $T$  (tau).

---

\*  $e$  is the base for natural logarithms and is used simply for mathematical convenience.  
 $e = 2.7183$

To illustrate what the reactor period is, consider the reactor power after one reactor period (ie,  $t = T$ )

$$P(T) = eP_0 \quad (\text{ie, power has increased by a factor of } e)$$

Also:

$$P(T) = P_0 e^{\frac{\Delta k}{\ell} T}$$

Therefore:

$$eP_0 = P_0 e^{\frac{\Delta k}{\ell} T}$$

$$e = e^{\frac{\Delta k}{\ell} T}$$

Clearly:

$$1 = \frac{\Delta k}{\ell} T$$

and:

$$T = \frac{\ell}{\Delta k} \quad (\text{reactor period for a reactor with only prompt neutrons})$$

Thus we can rewrite equation (1) as:

$$P(t) = P_0 e^{\frac{t}{T}} \quad (2)$$

Equation (2) is a valid expression for power as a function of time considering that we have only prompt neutrons.

To gain a feel for what this means, consider such a reactor with  $\Delta k = 0.5 \text{ mk}$ ;

$$T = \frac{0.001 \text{ s}}{0.0005} = 2 \text{ s}$$

This means that, with the reactor only slightly supercritical ( $k = 1.0005$ ), power is increasing by a factor of  $e$  ( $\sim 270\%$ ) every 2 seconds. That is about 176% per second\*.

---

\*Do not confuse this with rate  $\log N$  which would be 50%/s for this example.

This is an unacceptable rate of power change because it would be mechanically impossible to build a regulating system which could respond to such changes rapidly enough to safely control the reactor. Fortunately the fission process produces delayed neutrons which radically alter the time response from that of prompt neutrons alone.

### Effect of Delayed Neutrons

In Level 3 Nuclear Theory we simply assumed that the delayed neutrons increased the average neutron lifetime. This simple treatment is not only computationally inaccurate but it also fails to predict the physical way in which delayed neutrons affect the reactor. A more complex treatment is required for deeper understanding.

Again we will look at the time rate of change of the neutron density  $\frac{dn}{dt}$ , which can be written as:

$$\frac{dn}{dt} = \underbrace{\frac{kn}{\ell} (1 - \beta)}_{\text{Term 1}} + \underbrace{\lambda C}_{\text{Term 2}} - \underbrace{\frac{n}{\ell}}_{\text{Term 3}}$$

where:

Term 1 represents the production of prompt neutron in the present generation

Term 2 represents the production of delayed neutrons in the present generation

Term 3 represents the total neutrons in the preceding generation

$\lambda$  = delayed neutron precursor decay constant

$C$  = delayed neutron precursor concentration

With some mathematical manipulation:

$$\begin{aligned} \frac{dn}{dt} &= \frac{n}{\ell} (k(1 - \beta) - 1) + \lambda C \\ &= \frac{kn}{\ell} \left( \frac{k - k\beta - 1}{k} \right) + \lambda C \\ &= \frac{kn}{\ell} \left( \frac{k - 1}{k} - \beta \right) + \lambda C \end{aligned}$$

Finally:

$$\frac{dn}{dt} = \frac{kn}{\ell} (\Delta k - \beta) + \lambda C \quad (3)$$

Equation (3) partially describes how 'n' is changing; however,  $\lambda C$  is not a constant. We continually create delayed neutron precursors while other precursors, created earlier, decay to give us delayed neutrons. So we must describe how the precursor concentration changes:

$$\frac{dC}{dt} = \underbrace{\frac{kn}{\ell} \beta}_{\substack{\text{precursor} \\ \text{creation} \\ \text{rate}}} - \underbrace{\lambda C}_{\substack{\text{precursor} \\ \text{decay} \\ \text{rate}}}$$

Recalling that there are six groups of precursors you can see that we would have seven simultaneous differential equations to solve.

For a computationally accurate prediction of power changes, these equations are solved on a computer. For the purpose of understanding; however, we assume an average behaviour of the delayed neutrons which reduces the problem to solving two equations with a solution of the form:

$$P(t) = A_0 e^{a_0 t} + A_1 e^{a_1 t}$$

If we assume:

- a)  $\Delta k < \beta$
- b) a step change in  $\Delta k$  occurs at time zero
- c) neutron density was constant prior to the insertion of reactivity.

The solution (with certain approximations) is:

$$P(t) = P_0 \left( \underbrace{\frac{\beta}{\beta - \Delta k} e^{\frac{\lambda \Delta k}{\beta - \Delta k} t}}_{\text{1st Term}} - \underbrace{\frac{\Delta k}{\beta - \Delta k} e^{-\frac{\beta - \Delta k}{\ell} t}}_{\text{2nd Term}} \right) \quad (4)$$

A mathematical and graphical solution for a typical set of conditions is shown on the next page.



Assume typical values

$$\beta = 0.0065$$

$$\Delta k = 0.001 \text{ (1 mk)}$$

$$\lambda = 0.1 \text{ s}^{-1} \text{ (average for all precursor groups)}$$

$$l = 0.001 \text{ s}$$

$$\frac{P(t)}{P_0} = [1.18 e^{0.0182 t} - 0.18 e^{-5.5 t}]$$

This solution is plotted as figure (1).

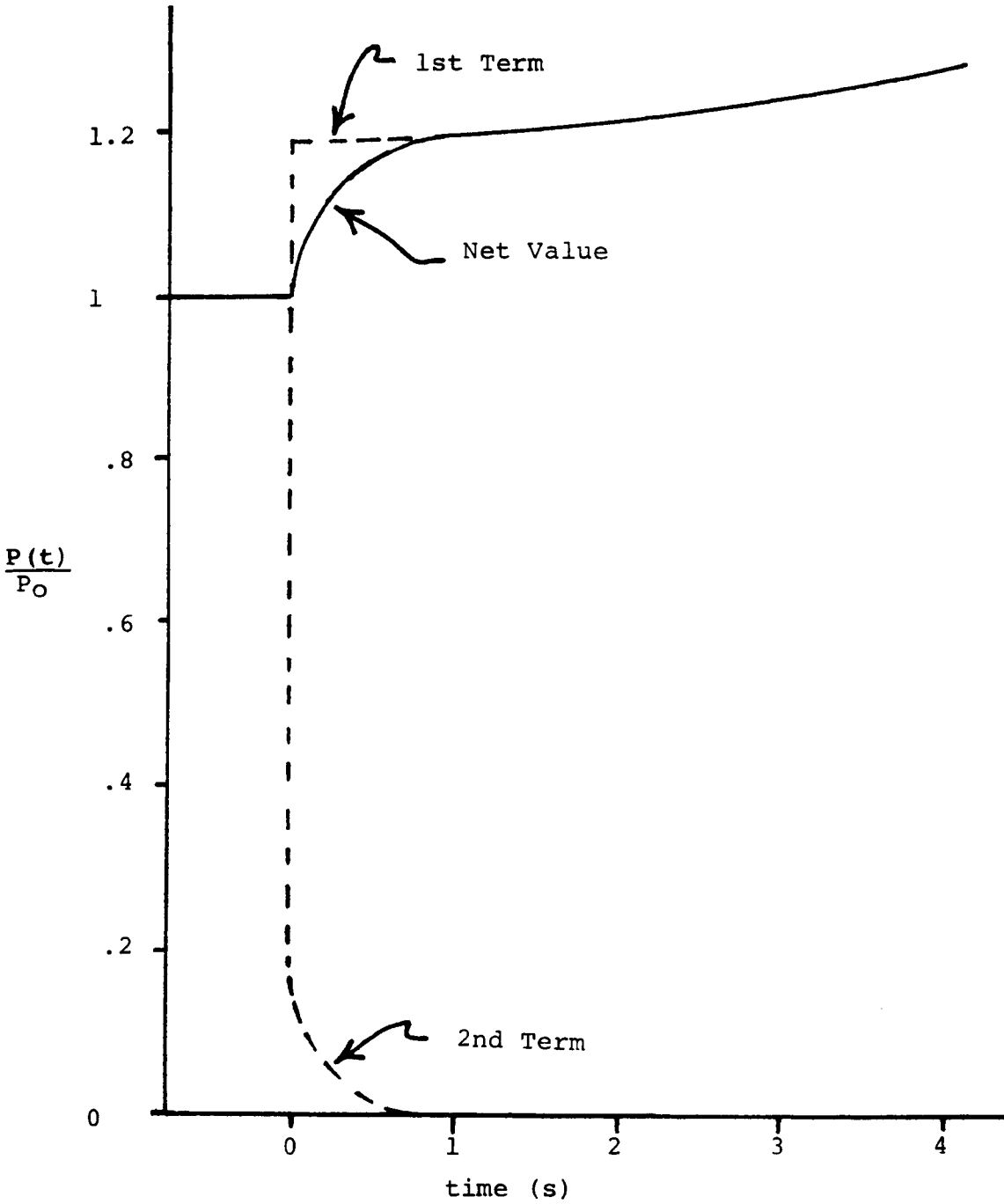

Figure 1

From this example you can see that the second term of equation (4) dies away rapidly and can usually be ignored.

If we do neglect the second term we have:

$$P(t) = \frac{\beta}{\beta - \Delta k} P_0 e^{\frac{\lambda \Delta k}{\beta - \Delta k} t} \quad (5)$$

Graphically this simplified equation is:

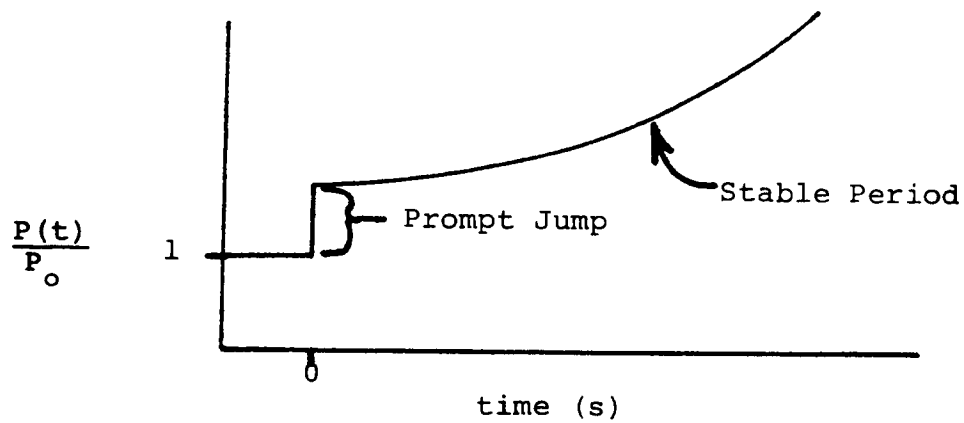

This behaviour is called a "prompt jump" followed by a "stable period" where the stable period  $(T) = \frac{\beta - \Delta k}{\lambda \Delta k}$ .

Physical Effect of Delayed Neutrons

To understand what is physically happening we will look at a simple numerical example using a greatly exaggerated value for  $\beta$ . This is done only for numerical simplicity and in no way alters the qualitative results.

Assume:

$$\begin{aligned} \beta &= .1 \\ \Delta k &= .05 \\ n_0 &= 1000 \end{aligned}$$

Prior to the reactivity insertion:

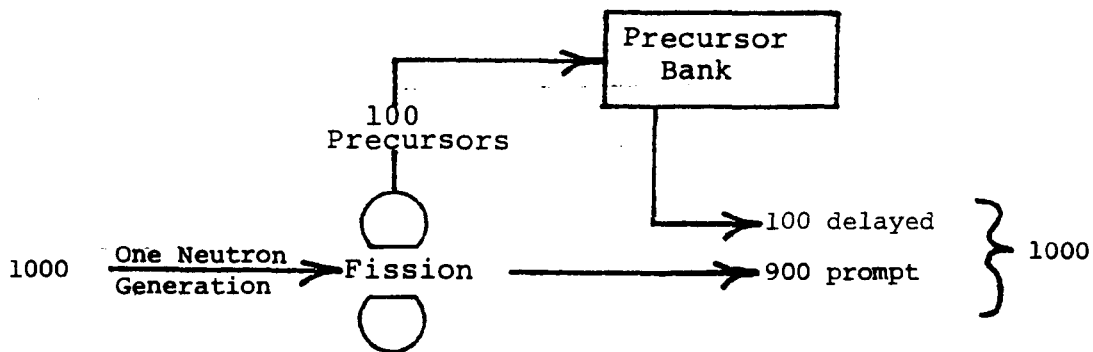

The chain reaction is being maintained at a level of 1000 neutrons per generation. Now insert 50 mk of reactivity such that  $k = 1.05$ :

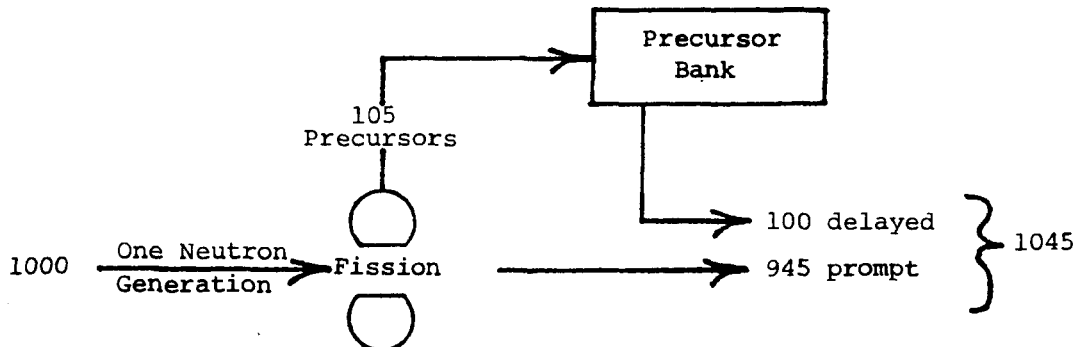

Even though we create 105 precursors we get only 100 delayed neutrons from the precursor bank since it contains precursors produced earlier.

This chain proceeds as follows:

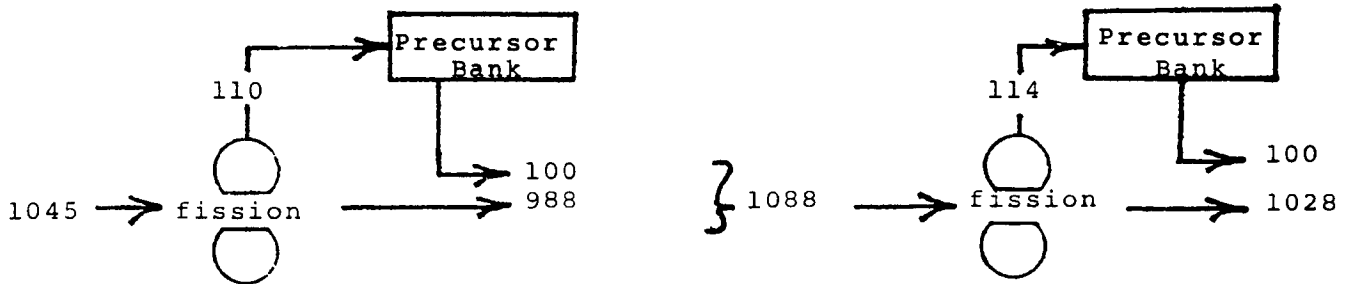

If we assume the output of the precursor bank does not change for a second, we have time for one thousand prompt generations in which time the series will converge to:

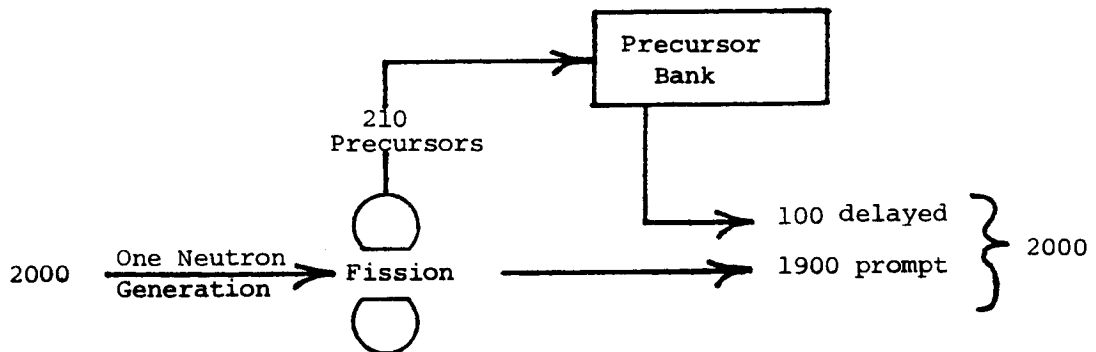

Thus in a very short time period we get a jump in the prompt neutron level but power can not increase beyond a certain point until more precursors start to decay. Therefore, after the prompt jump, the rate of power increase is determined by the decay rate of the delayed neutron precursors. Calculating the magnitude of the prompt jump for this problem using equation (5).

$$P = \frac{\beta}{\beta - \Delta k} \quad P_0 = \frac{.1}{.1 - .05} 1000 = 2000$$

### Approximate Numerical Effect of Delayed Neutrons

Going back to the problem we solved without delayed neutrons we shall now see what the effect of delayed neutrons really is.

Consider a reactor with U-235 as the fuel then:

$$\begin{aligned} \beta &= 0.0065 \\ \lambda &\approx 0.1 \text{ s}^{-1} \end{aligned}$$

The reactor period with  $\Delta k = 0.5 \text{ mk}$  is:

$$\begin{aligned} T &= \frac{\beta - \Delta k}{\lambda \Delta k} = \frac{0.0065 - 0.0005}{(0.1)(0.0005)} \\ &= 120 \text{ s} \end{aligned}$$

and the overall power function is:

$$\begin{aligned} P(t) &= P_0 \frac{\beta}{\beta - \Delta k} e^{\frac{t}{T}} \\ \frac{P(t)}{P_0} &= 1.08 e^{\frac{t}{120}} \end{aligned}$$

After the initial prompt jump to 108% of  $P_0$  power increases with a period of 120 s.

Figure 2 shows the power rise for a step insertion of reactivity. As you can see the average lifetime approximation (from Level 3) fails to predict the rapid initial rise in power caused by the multiplication of prompt neutrons. This rapid rise in power is an important consideration in the design of all reactivity mechanisms. In order to limit any rapid increase in power all reactivity mechanisms are designed to limit the rate of reactivity addition.

### Prompt Criticality

It may have occurred to you to ask why we restricted  $\Delta k$  to being less than  $\beta$ . For one thing the equations we derived are no longer valid but more importantly the increase in power is no longer dependent on delayed neutrons if  $\Delta k > \beta$ . Return to our numerical example with a value of  $\Delta k = .15$  with  $\beta = .1$ .

$$\begin{array}{l} 100 \text{ delayed} \\ 900 \text{ prompt} \end{array} \quad 1000 \times 1.15 \times (1 - .1) + 1040 \text{ prompt}$$

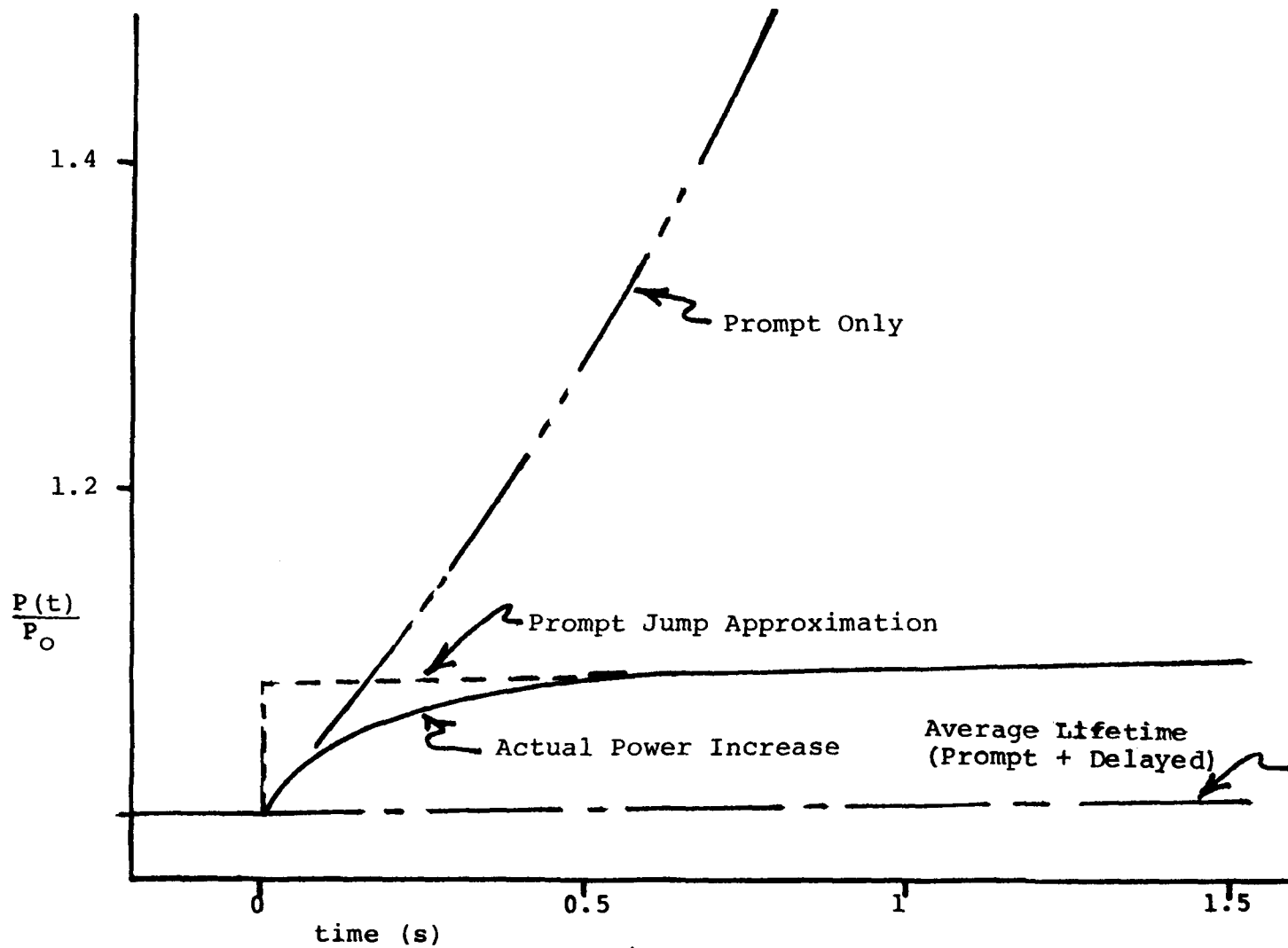

Figure 2

Power vs Time  
 (for a step insertion of  
 0.5 mk at  $t = 0$ )

As you see power is increasing without having to "wait" for the delayed neutrons. This shortens the reactor response time.

when  $\Delta k = \beta$  the reactor is critical on prompt neutrons alone, hence the name "prompt critical"

Figure 3 shows reactor period versus  $\Delta k$  for a reactor with a prompt lifetime of .001 seconds (i.e. the Candu reactors).

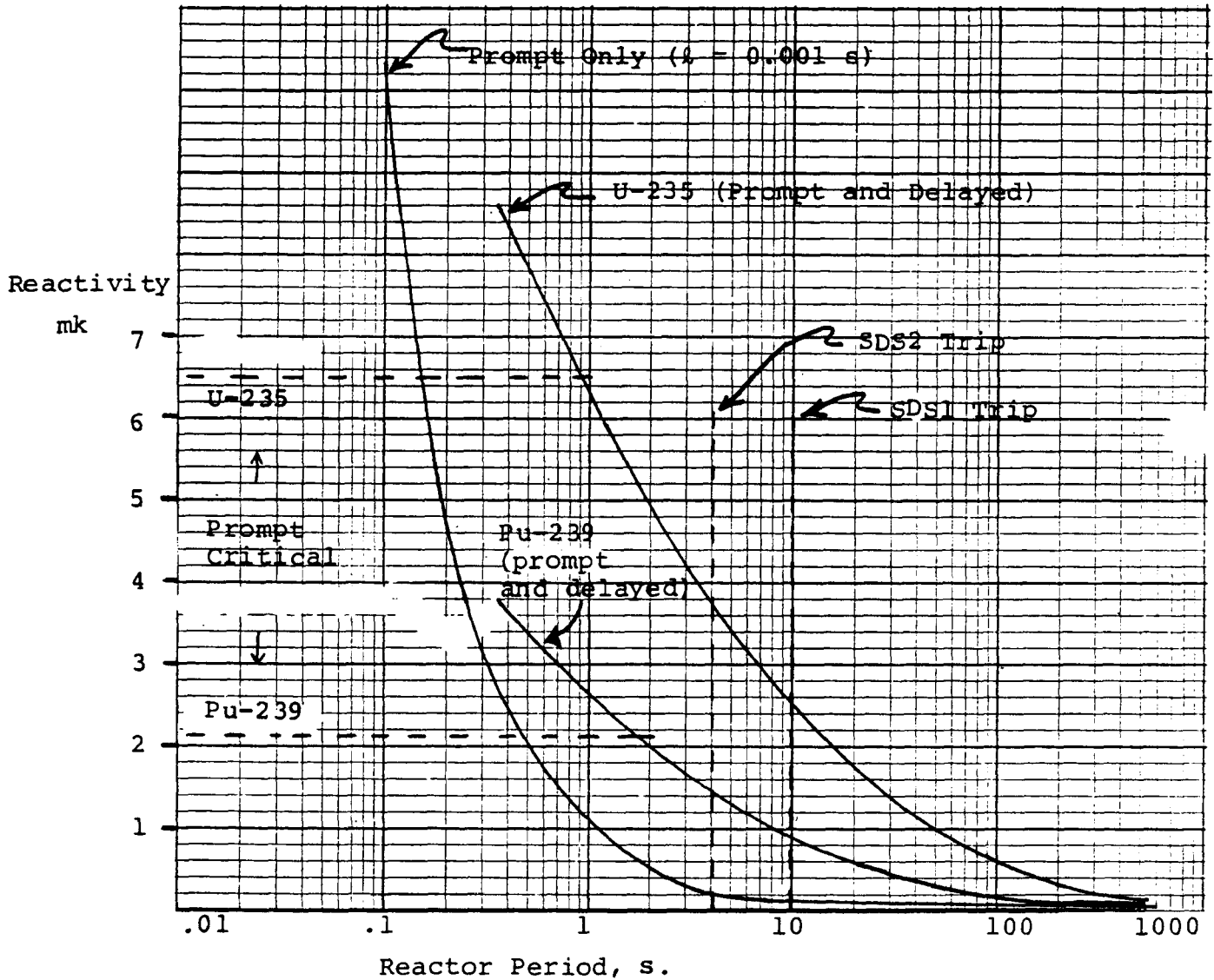

Figure 3

Reactivity v Period

As you can see nothing radically happens when the reactor approaches prompt criticality, the chain reaction is simply becoming less dependent on the delayed neutrons, hence power is changing more rapidly. In this regard we use the avoidance of prompt criticality as a design limit. (SDS1 trips the reactor at a period of 10 s and SDS2 trips the reactor at a period of 4 s. Both of these are below prompt criticality,  $T \approx 1$  s).

Also included on figure (3) is the plot of period versus reactivity for a reactor with only Pu-239 ( $\beta = 0.0021$ ) as a fuel. You will note that SDS1 and SDS2 trip set points provide adequate protection even in this situation. As we approach equilibrium fuel in our reactors we get closer to this situation. At equilibrium fuel prompt criticality occurs at  $\Delta k \approx 0.0035$ . The practical consequence of this is that the reactor regulating and protection system design must be based on the worst case which is equilibrium fuel.

#### Large Negative Reactivities (Reactor Trips)

The equations developed for the prompt jump are equally valid for any insertion of negative reactivity except that you have a prompt drop followed by a stable negative period. Recalling that:

$$T = \frac{\beta - \Delta k}{\lambda \Delta k}$$

if:

$$|\Delta k| \gg |\beta|$$

$$T \approx -\frac{1}{\lambda}$$

Thus the stable reactor period will be determined by the decay constant of the delayed neutron precursors. In fact it will be determined by the longest lived group of precursors, thus, the shortest reactor period possible after the prompt drop will be -80 s. In our reactors we have a very significant production of neutrons from the photoneutron reaction with deuterium thus the actual period will be somewhat longer.

#### ASSIGNMENT

1. Define reactor period (T).
2. Write the expression for reactor period considering both prompt and delayed neutrons.
3. Explain physically the way in which delayed neutrons effect the time response of neutron power.



4. Calculate reactor power 10 seconds after a step insertion of +2 mk of reactivity for fresh fuel ( $\beta = 0.0065$ ) and for equilibrium fuel ( $\beta = 0.0035$ ).  $P_0 = 50\%$  and  $\lambda = 0.1 \text{ s}^{-1}$ .
5. What do we measure on our reactors that is related to reactor period? What is the relationship?

J.E. Crist

## Nuclear Theory - Course 227

## SOURCE NEUTRON EFFECTS

The source neutrons available in CANDU reactors are those from spontaneous fission and those from the photoneutron reaction with deuterium. As mentioned in lesson 227.00-2, spontaneous fission produces a neutron flux which is approximately  $10^{-12}$ % of the full power flux. The strength of the photoneutron source depends on the number and energy of the photons present. At significant power levels ( $>10\%$ ) the gamma flux is directly proportional to the power level; thus, the photoneutron reaction produces a photoneutron flux which is proportional to the total neutron flux present. At low power levels and particularly when shutdown, the strength of the photoneutron source depends on the inventory of fission products which produce the high energy ( $>2.2$  MeV) gammas required for the photoneutron reaction. The longest lived relevant fission product decay chain has a half life of about 15 days; thus the photoneutron source persists for several weeks after shutdown, decreasing essentially exponentially from approximately  $10^{-5}$ % of full power one day after shutdown. As we shall see shortly the values given for the actual neutron fluxes in the reactor due to the photoneutron source do not include any fission multiplication of this source.

The Effect of Neutron Sources on the Total Neutron Population

In a critical reactor with no neutron sources other than induced fission, the neutron population in the reactor remains constant from one generation to the next. In other words, neutron losses due to absorption and leakage exactly take care of the excess neutrons generated by fission that are not required to keep the chain reaction going.

Now imagine a neutron source emitting  $S_0$  neutrons in each neutron generation time to be inserted into the reactor, and let this reactor be subcritical with a value of  $k$  just less than 1.

The number of neutrons present at the end of the first generation will be  $S_0$ , because that is how many are emitted in that time. At the end of the second generation, these  $S_0$  will have become  $S_0k$  neutrons, and another  $S_0$  neutrons will have been added by the source, giving us a total of  $S_0 + S_0k$ . At the end of the third generation these  $S_0 + S_0k$  neutrons will have become  $(S_0 + S_0k)k$  neutrons, and again another  $S_0$  neutrons will have been added by the source to give us a grand total of  $S_0 + S_0k + S_0k^2$ .

If you pursue this sort of argument indefinitely, you will appreciate that we are going to end up with a final neutron population,  $S_{\infty}$ , given by

$$S_{\infty} = S_0 + S_0 k + S_0 k^2 + S_0 k^3 + S_0 k^4 + \dots$$

$$= S_0 (1 + k + k^2 + k^3 + k^4 + \dots)$$

With  $k$  less than one, the sum

$$(1 + k + k^2 + k^3 + k^4 + \dots) = \frac{1}{1-k}$$

We can therefore say that

$$S_{\infty} = \frac{S_0}{1-k} \quad (1)$$

You can see that expression seems to be quite a reasonable one, because you can say if  $S_{\infty}$  is our final population, it will become  $S_{\infty}k$  after one more generation. If  $k$  is less than 1, this means that  $S_{\infty} - S_{\infty}k$  neutrons have been removed and these are made up by  $S_0$  new ones emitted.

For example if  $S_{\infty} = 5000$  neutrons generation and  $k = .8$ , these 5000 neutrons will become  $kS_{\infty}$  or 4000 neutrons in the next generation and the source  $S_0$  neutrons per generation time will make up the cycle losses  $(S_{\infty} - kS_{\infty})$  of 1000 neutrons generation. Thus;

$$S_0 = S_{\infty} - kS_{\infty}$$

or

$$S_{\infty} = \frac{S_0}{1-k} \quad (1)$$

By observing that;

$$1 - k = -\Delta k$$

we can rewrite equation (1) as;

$$S_{\infty} = - \frac{S_0}{\Delta k} \quad (2)$$

Equation (1) and (2) are equivalent and you may use whichever one is convenient.

While we have developed equations (1) and (2) in terms of  $S_{\infty}$  and  $S_0$  in neutrons per generation, the equations are equally valid in terms of power in watts or percent of full power as was shown in lesson 227.00-8.

### Subcritical Multiplication

It is important to realize that even in a reactor that is well below critical (eg, -40 mk, typical of a reactor trip) the equilibrium source level ( $S_{\infty}$ ) is 25 times greater than the actual photoneutron source.

$$S_{\infty} = \frac{S_0}{1 - .96} = \frac{S_0}{.04} = 25 S_0$$

The factor  $\left(\frac{1}{1-k}\right)$  can be called the *subcritical multiplication factor*. In the example above, the subcritical multiplication factor is 25. Thus, the indicated source level ( $S_{\infty}$ ) is 25 times the actual source level ( $S_0$ ). This means that fission is producing 25 times as many neutrons as the source. The amount of subcritical multiplication depends only on the value of  $k$ . For example, if we used only half of the shutoff rods used in the previous example, such that we had -20 mk:

$$S_{\infty} = \frac{1}{1 - .98} S_0 = 50 S_0$$

Now the subcritical multiplication factor is 50.

In a subcritical reactor without a neutron source the neutron population would totally collapse; however, when a source is present it is not the major constituent of the neutron population (provided  $k > 0.5$ ).

### Calculation of $k$ in a Subcritical Reactor

Suppose a reactor is shutdown with a constant indicated power of  $2 \times 10^{-5}\%$ . The operator inserts +1 mk by withdrawing an adjuster and power stabilizes at  $3 \times 10^{-5}\%$ . Find the original value of  $k$ .

For the first case before the reactivity addition;

$$P_{\infty} = \frac{P_0}{1 - k_i}$$

$$2 \times 10^{-5}\% = \frac{P_0}{1 - k_i}$$

After the reactivity addition;

$$3 \times 10^{-5}\% = \frac{P_0}{1 - (k_i + .001)}$$

Since  $P_0$  can be assumed to be the same in both cases, the equations may be solved for  $k_i$ .

$$P_0 = (1 - k_i) \times 2 \times 10^{-5}\%$$

$$P_0 = [1 - (k_i + .001)] \times 3 \times 10^{-5}\%$$

$$2 \times 10^{-5}\% (1 - k_i) = 3 \times 10^{-5}\% (.999 - k_i)$$

$$2 - 2 k_i = 2.997 - 3 k_i$$

$$\underline{k_i = .997}$$

You can always find the value of  $k$  in a shutdown reactor by changing reactivity, noting the power before and after a change and doing a simple calculation.

### Time Considerations

In a subcritical reactor the power will increase to a new equilibrium value each time positive reactivity is added. The magnitude of the increase and the time it takes for power to stabilize will depend on the value of  $k$ . The closer  $k$  is to one the larger the power increase for a given reactivity increase, and the longer the time for power to stabilize. This is demonstrated in Figure 1 where we start with  $P_{\infty} = 1 \times 10^{-5}\%$  and  $k = 0.90$  and add reactivity in +10 mk steps allowing  $P_{\infty}$  to stabilize after each reactivity addition.

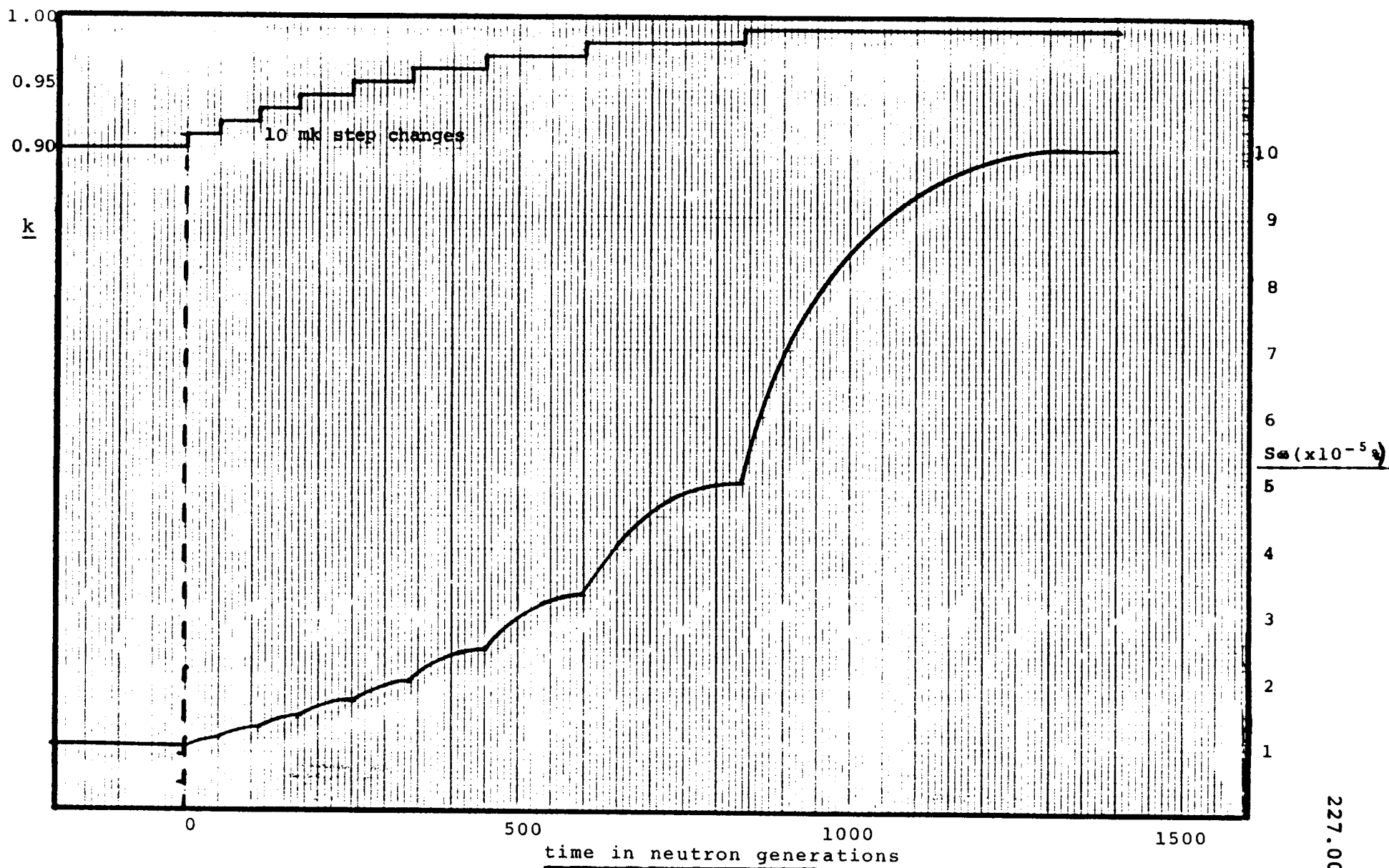

**FIGURE 1**

Power increase in a subcritical reactor.

Justification for relative magnitudes of the power increases can be done in a straightforward manner using equation (1) or (2) and is left to the student. The time consideration is somewhat more obscure. Assume we start with a source

$S_0 = 1000 \frac{\text{neutrons}}{\text{generation}}$  at time zero and ask the question, "How long will it take to reach equilibrium ( $S_\infty$ )? Equilibrium will be obtained when the effect of the first group of  $S_0$  neutrons has totally disappeared (ie,  $S_0 k^N = 0$  or  $k^N = 0$ , where  $N$  is the number of neutron generations). For example, we will compare the number of generations required for the first group of source neutron to disappear with  $k = 0.8, 0.9,$  and  $0.95$ . The tabulated values are  $S_0 k^N$ .

$k \backslash N$	1	2	3	...	30	...	62	...	127
0.80	800	640	512	...	1	...	-	...	-
0.90	900	810	729	...	42	...	1	...	-
0.95	950	903	857	...	215	...	42	...	1

As you see, with  $k = 0.8$  it would take about 30 generations to reach equilibrium, with  $k = 0.9$  about 62 generations, and with  $k = 0.95$  about 127 generations. (Strictly of course it takes an infinite time, this example gets to within 0.1%.)

#### Effect of Sources when $k > 1$

When the reactor is critical, equations (1) and (2) don't apply because they are based on the assumption that the series  $1 + k + k^2 + k^3 + k^4 + \dots$  has a finite sum. When constant, and  $S_0$  new ones will be added every generation, so that the neutron population will then merely increase indefinitely and at a constant rate of  $S_0$  neutrons for every generation.

This rate of increase is insignificant if the reactor power is greater than  $\sim 10^{-2}\%$  and would generally be obscured by the automatic regulation of the reactor. In a supercritical reactor any effects of the sources may be ignored.

ASSIGNMENT

1. Explain why the total neutron population in a subcritical reactor is significantly higher than the source level.
2. Define the subcritical multiplication factor.
3. Explain why it is possible to have a constant fission rate in a subcritical reactor.
4. Assuming  $S_0 = 1000 \frac{\text{neutrons}}{\text{generation}}$  and the average neutron lifetime is 0.1 seconds, how long will it take to reach equilibrium when  $k = 0.999$ ? (You need a calculator for this problem.)

J.E. Crist  
A. Broughton



## Nuclear Theory - Course 227

## POWER AND POWER MEASUREMENT

We tend to use the term "power" rather loosely and we need to have clear understanding of what "power" we are talking about. The power we have referred to most frequently in this course is *neutron power* which is equivalent to the fission rate. However, the actual output of the reactor is in the form of heat energy and we call the heat output *reactor thermal power*. Normally we calibrate our instruments such that 100% neutron power corresponds to 100% of the thermal power required from the reactor to provide the design heat input to the turbine cycle.\*

The "power" we normally rate the overall unit by is the *gross electrical power* output of the generator. By way of example, Pickering-A reactors produce 540 MW(e), gross generator output, for a thermal power from the reactor of 1652 MW(th) which corresponds to an average thermal neutron flux of  $5.3 \times 10^{13} \frac{\text{neutron.cm}}{\text{cm}^3 \cdot \text{s}}$ .

Thermal Power and Neutron Power

Thermal power is generally measured by measuring the primary heat transport flow rate ( $\dot{m}$ ) and temperature change ( $\Delta T$ ) in selected coolant channels (called fully instrumented channels). Recall from Thermodynamics (325) that:

$$Q = \dot{m}C\Delta T$$

Where:  $Q$  = thermal power (watts [thermal])

$\dot{m}$  = flow rate (kg/s)

$C$  = Specific Heat ( $\frac{\text{J}}{\text{kg}^\circ\text{C}}$ )

$\Delta T$  = ( $T_{\text{out}} - T_{\text{in}}$ ) for the channel ( $^\circ\text{C}$ )

\*At some stations the DCC automatically calibrates neutron power to be equal to thermal power above  $\sim 10\%$  full power.

Neutron Power is measured either by ion chambers located external to the calandria or by in-core flux detectors.

Thermal power has the advantage of being the actual, useful power output of the reactor. The measurements have the disadvantages of having an excessive time lag between neutron power changes and detected thermal power changes (around 25s, see 330.3 Lesson 34-2) and a non-linear relationship with neutron power especially at low power levels. The importance of the time lag may be seen by calculating the neutron power change that would occur in the time before there is any detected change in the channel  $\Delta T$  (assume this to be about 5s). With an inserting of + 1mk of reactivity at equilibrium fuel: using equation (5) from lesson 227.00-8,

$$\begin{aligned} \frac{P}{P_0} &= \frac{\beta}{\beta - \Delta k} e^{\frac{\lambda \Delta k}{\beta - \Delta k} t} \\ &= \frac{.0035}{.0035 - .001} e^{\frac{(.1)(.001)}{.0035 - .001} 5} \\ &= 1.4 e^{.2} \\ &= 1.7 \end{aligned}$$

Neutron Power would increase by a factor of 1.7 before detected thermal power even started to change. It should be clear that thermal power measurement is incapable of protecting the reactor from a rapid increase of reactivity, in fact it is rather slow even for normal control.

The non-linearity between thermal power and neutron power is due principally to fission product decay heat. Approximately 7% of the total reactor thermal power is produced by the  $\beta, \gamma$  decay of the fission products. Thus in a reactor operating at 100% of rated thermal output, 7% of the thermal power is due to decay heat. Even if it were possible to instantaneously stop all fissioning (neutron power  $\approx 0\%$ ), the thermal output would still be 7% of full power and would decay over a long period of time. Figure 1 is a graph of a typical rundown of neutron power and thermal power after a reactor trip. Note that after a minute the neutron power makes very little contribution to the thermal power.

Figure 1

Rundown of Thermal and Neutron Power After a Trip from Full Power at 0 Seconds

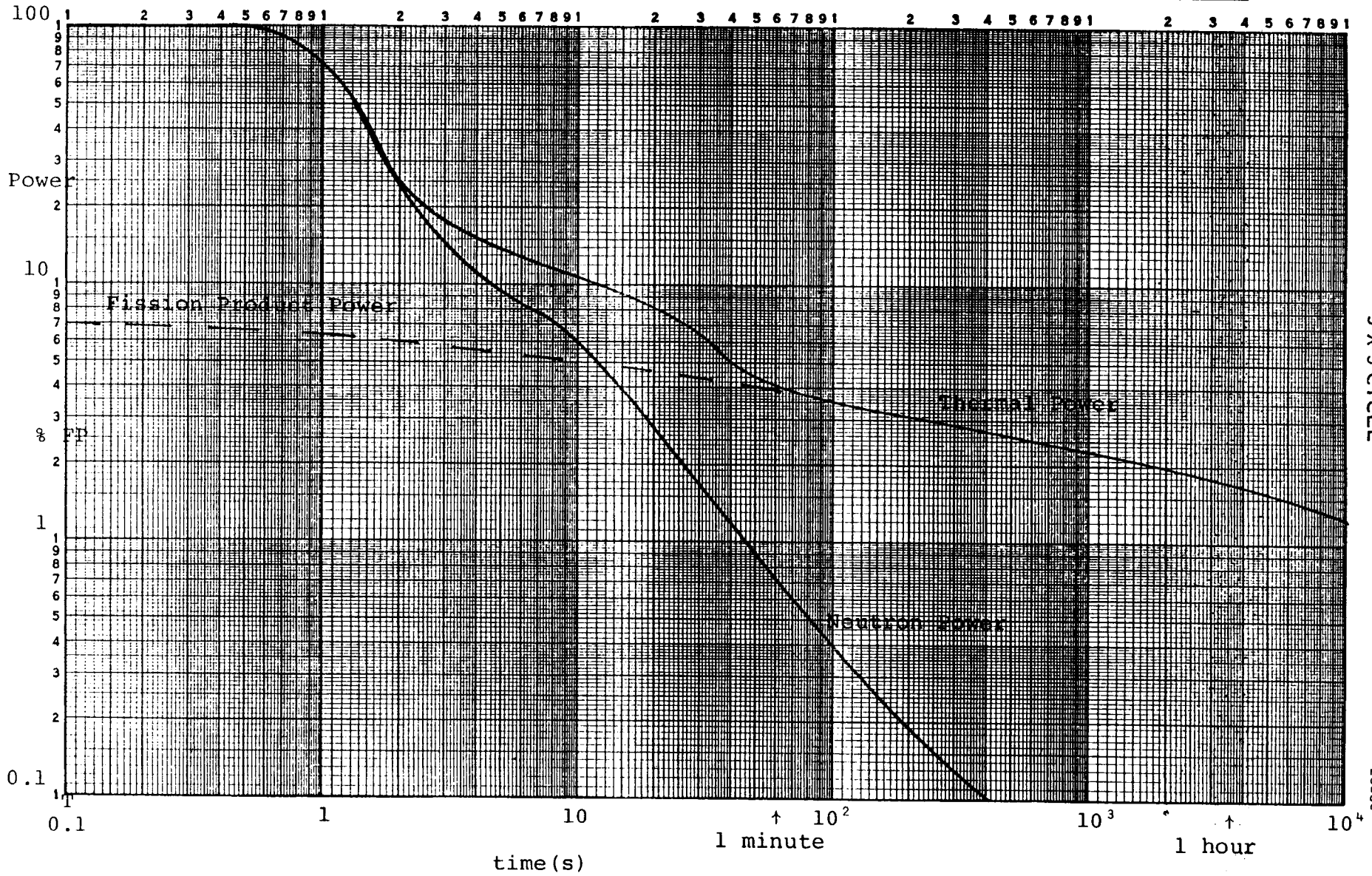

3 X 5 CYCLE

227.00-10

26050

A second source of non-linearity is the heat lost from the coolant channels to the moderator (eg,  $\sim 4$  MW[th] at BNGS-A). The amount of heat lost is a function of the temperature difference between the coolant and the moderator and is, therefore, relatively independent of the power.

A third source of non-linearity is the heat generated by fluid friction. About two-thirds of the pressure drop in the heat transport system occurs in the coolant channels. This means that about two-thirds of the heat input of the heat transport pumps shows up in the coolant channels (eg,  $\sim 13$  MW[th] at BNGS-A). This depends only on coolant flow rate and is independent of reactor power level.

Because of these non-linearities we must recalibrate neutron power to thermal power if the power level is changed.

#### Power Monitoring when Shutdown

As you might surmise from Figure 1, thermal power and neutron power are not proportional when power is  $\lesssim 10\%$ . To protect the reactor against criticality accidents we must therefore monitor neutron power, especially at low power levels.

Assume for a moment that we built a protective system which used thermal power as the control variable. The reactor is slightly subcritical ( $k = 0.999$ ) and the neutron power is  $10^{-5}\%$ . Since the response time of the  $\Delta T$  detector is about 25 seconds, we would expect thermal power to lag neutron power such that, about 25 seconds after neutron power reacted,  $1\%$  thermal power would indicate  $1\%$ . Now assume the reactor is inadvertently made supercritical ( $k = 1.003$ ). For equilibrium fuel,  $+3$  mk gives a reactor period of  $\approx 2$  seconds. Thus 22 seconds after the reactivity addition, neutron power will reach  $1\%$ ,  $\approx 25$  seconds after that, thermal power will reach  $1\%$  and begin to show a rapid rate of change. In those intervening 25 seconds neutron power will reach  $\approx 27,000\%$ .

If this reactor had been monitored for neutron power and rate of change of neutron power, the excursion could have been terminated long before power reached  $1\%$ . (Typically SDS 1 trips at a reactor period of 10s and SDS 2 trips at a period of 4 s.)

#### Uses of Power Measurements

1. Thermal Power is used for calibration of total neutron power and as a continuous checking function for zone power.

2. Neutron Power is used in two ways:
- Linear Neutron Power (linear N) may be used for indication, protection (high power trip) and/or control in the range of 15% to 120% neutron power.
  - The logarithm of Neutron Power (log N) is normally used for indication and control in the range of  $10^{-5}\%$  to 15% neutron power (although the meter goes to 100% and controls to 100% if linear N fails).
3. Rate of change of neutron power may again be used in two different manners:
- Linear Rate is the rate of change of linear neutron power displayed as percentage change of full power per second (%FP/s). (Not always used.)
  - Rate Log is the rate of change of the logarithm of neutron power in percent of present power per second (%/s). Rate Log is normally used for protection against excessive rates of change of power and is the inverse of reactor period. Recall that in its simplest form power may be expressed as:

$$P = P_0 e^{t/T}$$

Then the natural logarithm of power is:

$$\begin{aligned} \ln P &= \ln P_0 + \frac{t}{T} \ln e \\ \text{or } \ln P &= \ln P_0 + \frac{t}{T} \end{aligned}$$

The rate of change of the log of power is the derivative with respect to time, thus;

$$\frac{d}{dt} (\ln P) = \frac{d}{dt} (\ln P_0) + \frac{d}{dt} (t/T)$$

$$\underbrace{\frac{d}{dt} (\ln P)}_{\text{Rate Log}} = \frac{1}{T}$$

A typical trip setpoint (SDS-1) is a Rate log of 10%/s which corresponds to a reactor period of 10s.

### Behaviour of Power After a Trip

Assume a Candu reactor is running at 100% full power, with equilibrium fuel, and a reactor trip inserts -40 mk of reactivity. Figure 2 shows the theoretical behaviour of neutron power and thermal power. The remainder of this section will explain why the powers behave in this manner.

### Neutron Power Rundown

We will divide the power rundown into three regions. In region I the prompt neutron population is rapidly collapsing. With  $K = 0.96$  (ie, with typical shutdown reactivity of -40 mk) the original prompt neutron population would decrease by a factor of 0.96 each generation. In 100 generations it would be less than 2%\* of its original value.

With a prompt neutron lifetime of 0.001 s, this decrease would take 0.1 s. Because of the delayed and photoneutrons, the actual neutron power will, however, not drop quite this fast nor will it drop this far.

Just before the reactivity insertion, delayed neutrons made up 0.35%\*\* of the neutron population (ie, 99.65% of the fissions were caused by prompt neutrons, 0.35% were caused by delayed neutrons). Immediately after the insertion, if we assume the prompt neutrons disappear we have a source of neutron (0.35% of full power) in a subcritical reactor; thus we can use the equation for neutron power in a subcritical reactor:

$$P_{\infty} = - \frac{P_0}{\Delta k}$$

$$P_{\infty} = - \frac{0.35\%}{-0.040}$$

$$= 8.75\% \text{ of full power.}$$

$$* n = n_0 k^n$$

$$\frac{n}{n_0} = (0.96)^{100} = 0.017$$

\*\*The delayed neutron fraction ( $\beta$ ) for equilibrium fuel is 0.0035.

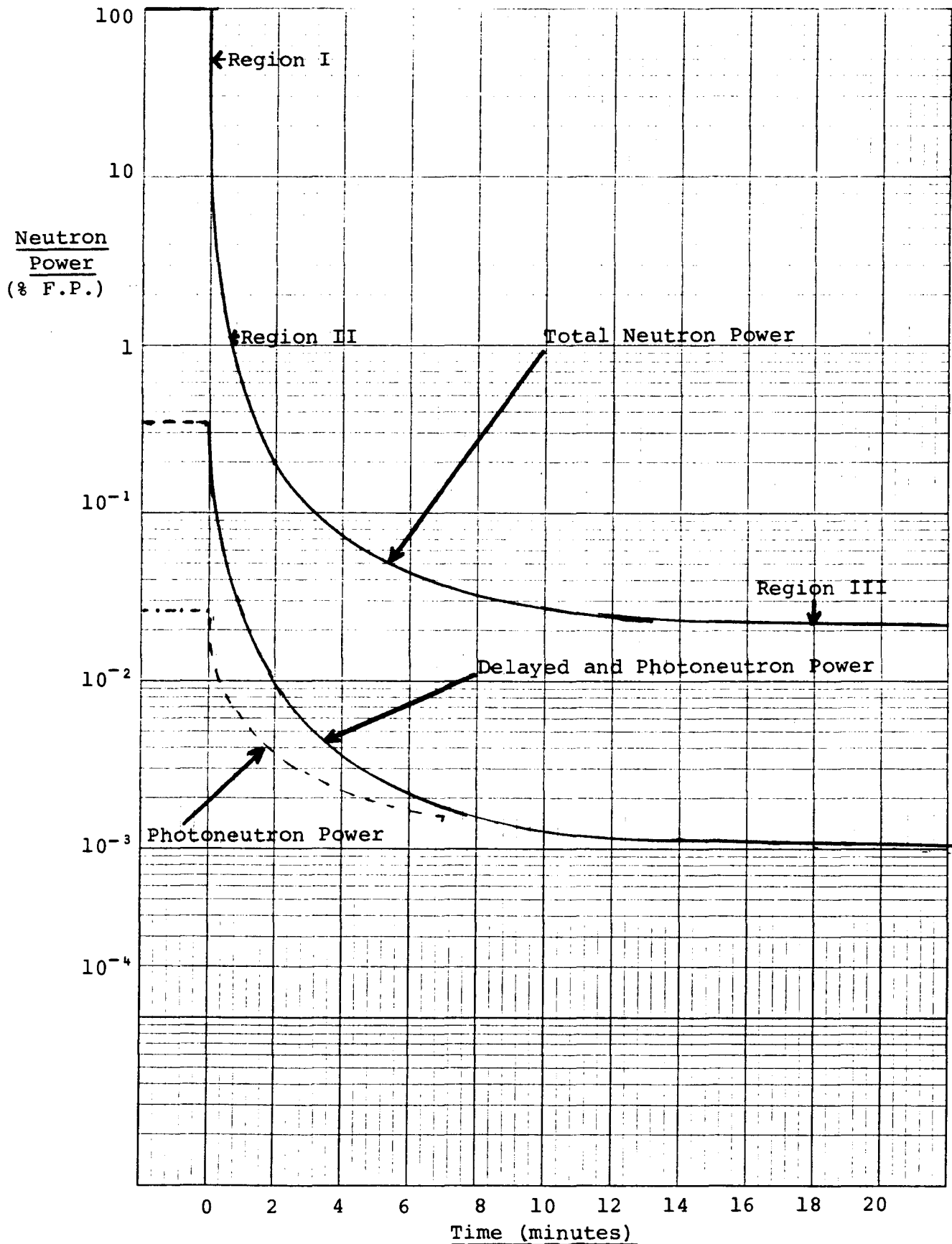

Figure 2 Neutron Power Rundown After Shutdown

Therefore, the delayed neutrons present at the time of the trip will not let the neutron power drop initially below ~9% as shown in Figure 2. (Remember the actual drop is determined by the value of  $\Delta k$  inserted and the value of  $\beta$ .)

A second way to reach this conclusion is to recall from Lesson 227.00-8 that neutron power may be approximately calculated using:

$$P(t) = P_0 \frac{\beta}{\beta - \Delta k} e^{\frac{\lambda \Delta k}{\beta - \Delta k} t}$$

where:

$$\frac{\beta}{\beta - \Delta k}$$

is the power after the prompt drop, which in this case gives;

$$P(0) = \frac{0.0035}{0.0035 + 0.040} \times 100\% = 8.05\%$$

which is nearly the same answer we got before. Either method is an acceptable approximation.

As the reactor is subcritical, the equation for power in a subcritical reactor applies throughout regions II and III. In region II the source of neutrons is the decay of the delayed neutron precursors which were present prior to shutdown. This source decreases rapidly at first as the short-lived precursors decay and slows down until the longest-lived group ( $t_{1/2} = 55$  s) controls the rate of power decrease.

As was pointed out in Lesson 227.00-8, the reactor period after a large insertion of negative reactivity may be approximated as:

$$T \approx - \frac{1}{\lambda}$$

where,  $\lambda$  is the decay constant for the delayed neutron precursors.

The division between regions II and III is somewhat arbitrary. As the longer-lived delayed neutron precursors decay away, the photoneutrons are now the only important source of neutrons. Somewhere around 20 minutes after shutdown, the photoneutrons become the controlling source. From then on the power decreases at a rate determined by the decay of the fission fragments producing the 2.2 MeV photons required for the photoneutron reaction. As the longest-lived photoneutron producing fission fragments have half-lives of ~15 days, this source takes about 3 months to reduce to  $10^{-5}\%$  full power.



### Thermal Power Rundown

At full power ~7% of the total thermal power is produced by the decay heat of the fission products (see Lesson 227.00-2). Although the fission rate can decrease very rapidly, the heat produced by decay of fission products (called decay heat) will only decrease at the decay rate of the fission products. Fission products have half-lives ranging from fractions of a second to thousands of years. Thus we expect a very slow decrease in thermal power. Typically thermal power will take about a day to decrease to 1% of full power. (For a Bruce reactor this is ~29 MW[th]).

The actual thermal power rundown will depend on the fission product inventory. A reactor at equilibrium fuel will have more fission products than one with relatively fresh fuel. therefore, it would produce a greater decay heat. This difference in production of decay heat will become more pronounced as time passes and the longer-lived fission products become more significant.

### ASSIGNMENT

1. Discuss the advantages and disadvantages of neutron power and thermal power for controlling a reactor when:
  - a) At significant power levels (>10%)
  - b) When shutdown.
  
2. A reactor has been operating at 100% thermal and neutron power for a long time. Neutron power is reduced to 50%. Will thermal power be higher than, lower than, or equal to 50%? Explain your answer. (Assume calibration is done only at 100%.)
  
3. A reactor is operating at 15% thermal and neutron power. Neutron power is raised to 50%. Will thermal power be equal to, greater than, or less than 50%? Explain your answer. (Assume calibration is done only at 15%.)

4. A reactor is being started up by removing Boron from the moderator. Assume the ion exchangers (IX) remove the Boron at a constant rate. The power at one time on the He-3 counter is  $10^{-6}\%$ . After one hour of IX removal, power stabilizes at  $1.2 \times 10^{-6}\%$ . How much longer will ion exchange be required before the reactor is critical?
5. Calculate the power after the initial drop in power if a trip inserts -30 mk in a reactor with fresh fuel ( $\beta = 0.0065$ ). Use two methods.
6. Explain why, for a given reactor, the decay heat rate should be higher when it has reached equilibrium fuel than when it was running on fresh fuel.

J.E. Crist  
A. Broughton

## Nuclear Theory - Course 227

## FISSION PRODUCT POISONING

All Fission products can be classified as reactor poisons because they all absorb neutrons to some extent. Most simply buildup slowly as the fuel burns up and are accounted for as a long term reactivity effect (as we did in lesson 227.00-7). However, two of the fission products, Xe-135 and Sm-149, are significant by themselves due to their absorption cross section and high production as fission products or fission product daughters. Xenon-135 has a microscopic absorption cross section of  $3.5 \times 10^6$  barns and a total fission product yield of 6.6%. Samarium-149 has an absorption cross section of 42,000 barns and a total fission product yield of 1.4%. Xenon-135 is the more important of the two and will be dealt with in more detail.

Xenon-135

Xenon-135 (often carelessly referred to just as xenon) is produced in the fuel in two ways:

- a) Directly from fission. About 0.3% of all fission products are Xe-135.
- b) Indirectly from the decay of iodine-135, which is either produced as a fission product or from the decay of the fission product tellurium-135 via the following decay chain:

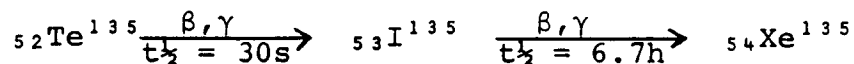

Te-135 and I-135 together constitute about 6.3% of all fission products. Due to the short half-life of Te-135 we normally consider the whole 6.3% to be produced as I-135. The rate of production of xenon and iodine from fission depends on the fission rate. Thus:

Rate of production  
of Xe-135 from fission =  $\gamma_{\text{Xe}} \Sigma_f \phi$

$$\text{Rate of production of I -135 from fission} = \gamma_I \Sigma_f \phi$$

- where:  $\gamma_{Xe}$  = Fission product yield of Xe  
 $\gamma_I$  = Fission product yield of I  
 $\Sigma_f$  = Microscopic fission cross section  
 $\phi$  = Average thermal neutron flux

The rate of production of xenon from iodine depends only on the decay of the iodine, thus:

$$\text{Rate of production of Xe -135 from I -135} = \lambda_I N_I$$

- where:  $\lambda_I$  = decay constant for I -135 ( $S^{-1}$ )  
 $N_I$  = concentration of I -135 ( $\frac{\text{atoms}}{\text{cm}^3}$ )

Xenon-135 is removed (or changed) by two processes:

- a) Radioactive decay as follows:

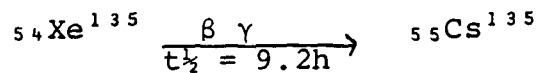

- b) Neutron absorption (burnout):



Niether Cs -135 nor Xe -136 are significant neutron absorbers. The removal rates are as follows:

$$\text{Rate of change of Xe -135 by decay} = \lambda_{Xe} N_{Xe}$$

$$\text{Rate of change of Xe -135 by burnout} = \sigma_a^{Xe} N_{Xe} \phi$$

- where:  $\lambda_{Xe}$  = decay constant for Xe -135  
 $N_{Xe}$  = Concentration of Xe -135  
 $\sigma_a^{Xe}$  = microscopic absorption cross section  
 $\phi$  = thermal neutron flux

Now we can set up two equations, one which describes the behaviour of xenon and one which describes the behaviour of iodine. The time rate of change of the iodine ( $\frac{d N_I}{dt}$ ) is:

$$\frac{d}{dt} N_I = \underbrace{\gamma_I \Sigma_f \phi}_{\text{Production from fission}} - \underbrace{\lambda_I N_I}_{\text{Loss due to decay}} \quad (1)$$

The time rate of changes of the xenon ( $\frac{d}{dt} N_{Xe}$ ) is:

$$\frac{d}{dt} N_{Xe} = \underbrace{\gamma_{Xe} \Sigma_f \phi}_{\text{Production from fission}} + \underbrace{\lambda_I N_I}_{\text{Production from the decay of Iodine}} - \underbrace{\lambda_{Xe} N_{Xe}}_{\text{Loss due to decay}} - \underbrace{\sigma_a^{Xe} N_{Xe} \phi}_{\text{Loss due to burnup}} \quad (2)$$

We would like to examine the buildup of xenon in the reactor; however, since much of the xenon comes from iodine we must examine the behaviour of iodine first.

Examining equation (1) you can see that if we startup a reactor with no iodine present we will initially have a production term ( $\gamma_I \Sigma_f \phi$ ) but no loss term since  $N_I$  is zero. As iodine is created the loss term grows ( $N_I$  is increasing) while production term remains constant (for constant power). Eventually the loss will equal the production and the iodine level will remain constant. Mathematically:

$$\frac{d}{dt} N_I = 0 = \gamma_I \Sigma_f \phi - \lambda_I N_I$$

$$\lambda_I N_I = \gamma_I \Sigma_f \phi$$

$$\underbrace{N_I}_{\text{Equilibrium iodine concentration}} = \frac{\gamma_I \Sigma_f \phi}{\lambda_I}$$

Equilibrium  
iodine  
concentration.

This is a simple exponential buildup which can be considered to reach equilibrium after about five half-lives or 30 hours (within 3%). The buildup is shown in Figure 1.

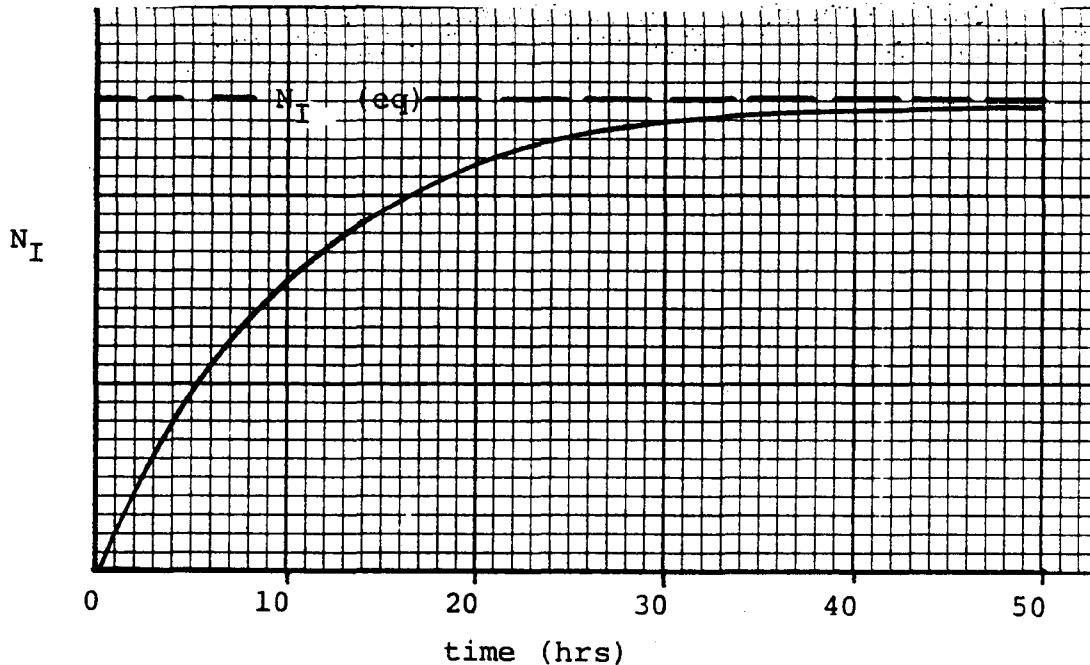

Figure 1

Now we are able to examine the behaviour of xenon. The buildup of xenon is somewhat more complex than the buildup of iodine. Again at equilibrium,  $\frac{d}{dt} N_{Xe} = 0$ , and production equals loss. Also iodine must be in equilibrium so  $\gamma_I \Sigma_f \phi = \lambda_I N_I$ . Thus we can write:

$$\gamma_{Xe} \Sigma_f \phi + \gamma_I \Sigma_f \phi = \lambda_{Xe} N_{Xe} + \sigma_a^{Xe} N_{Xe} \phi \quad (3)$$

Rearranging:

$$\underbrace{N_{Xe}}_{\text{Equilibrium Xe concentration}} = \frac{(\gamma_{Xe} + \gamma_I) \Sigma_f \phi}{\lambda_{Xe} + \sigma_a^{Xe} \phi}$$

The buildup is shown graphically in Figure 2.

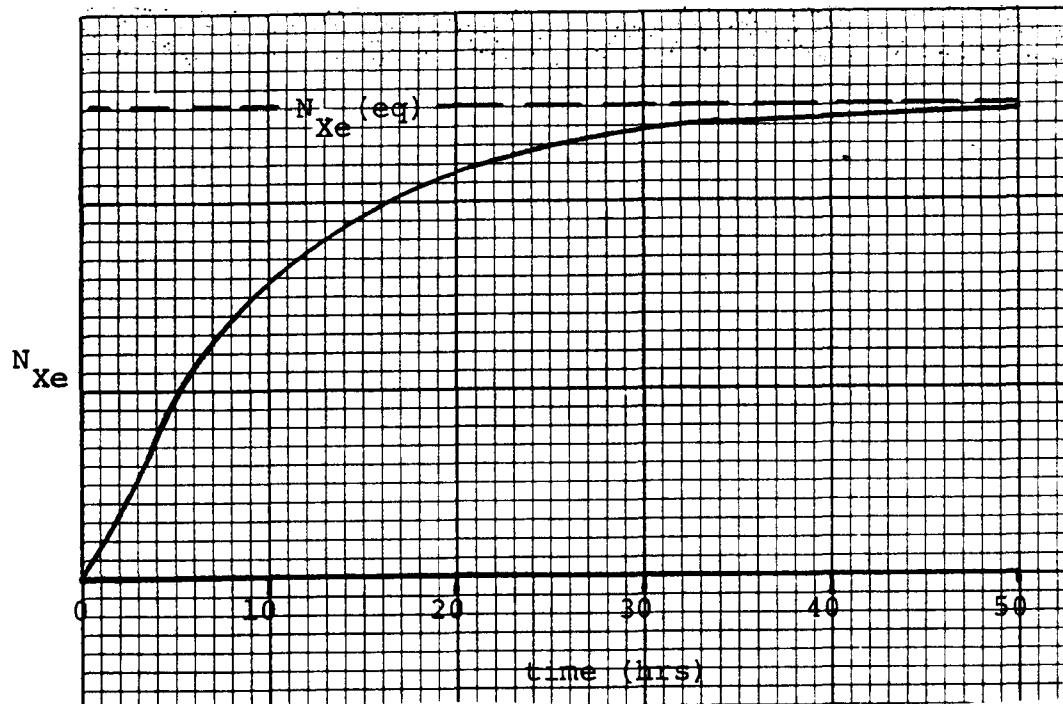

Figure 2

It again takes about 5 half-lives to reach equilibrium and for xenon this is about 50 hours.

It is useful to know the relative importance of the production and loss terms for xenon at equilibrium. Examining equation (3) we see the relative importance of the production terms depend only on their respective fission product yields. Thus direct production of Xe-135 from fission is about 5% of the total production at equilibrium while indirect production from the decay of I-135 is 95% of the total production.

In examining the loss terms, note that the loss due to decay depends only on the decay constant ( $\lambda_{Xe}$ ). The loss due to burnout depends on the cross section ( $\sigma_a^{Xe}$ ) and the neutron flux. Therefore, the relative importance of the loss terms varies from reactor to reactor depending on the normal flux levels. For a given reactor the relative importance varies with power level. For our larger reactors (Bruce and Pickering) full power flux is  $7 \times 10^{13} \frac{n-cm}{cm^3 s}$

$$\text{Thus; } \gamma_{\text{Xe}} = 2.1 \times 10^{-5} \text{ s}^{-1}$$

$$\sigma_{\text{Xe}} = 24.5 \times 10^{-5} \text{ s}^{-1}$$

Therefore, burnout constitutes more than 90% of the loss at full power.

### Reactivity

The reactivity worth of xenon (called Xenon Load) is a function of the concentration of xenon. As it is the reactivity due to xenon that we are concerned about, it is normal to express Xenon Load in reactivity units ( $\Delta k_{\text{Xe}}$ ). As shown in Figure 3, the equilibrium Xenon Load for 100% is about -28 mk.

It is also common practice to express the concentration of iodine as Iodine Load in mk. It is important to realize that iodine is not itself a poison hence there is no actual reactivity associated with it. *Iodine Load* is by definition the reactivity if all the iodine present were instantaneously changed to xenon. I repeat it is not an actual reactivity.

By examining the equations for equilibrium xenon and iodine it can be deduced that equilibrium Iodine Load is a direct function of power (eg, doubling the power doubles the Iodine Load) whereas equilibrium Xenon Load does not have such a straightforward relationship with power. Figure 3 shows the approximate variation of equilibrium Xenon Load with power for Bruce or Pickering. The significant point is that equilibrium Xenon Load doesn't change much over the normal operating range.



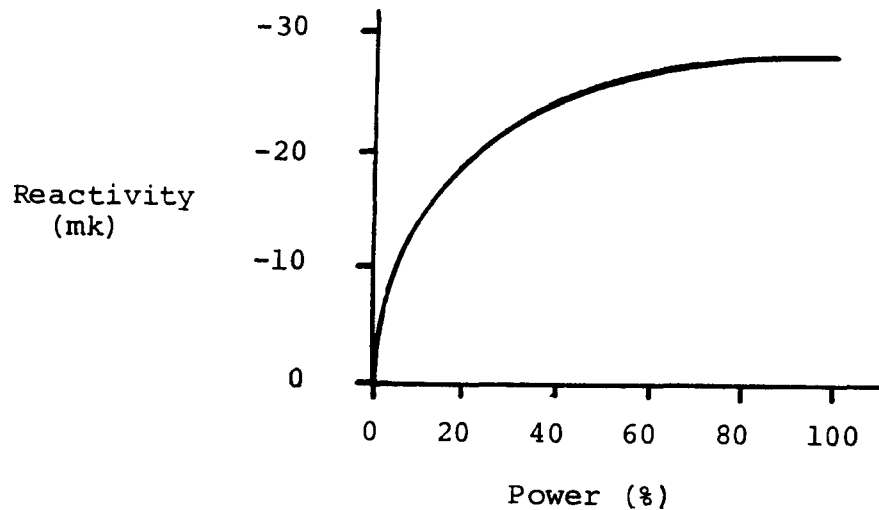

Figure 3

### Xenon Simulation

The reactivity due to Equilibrium Xenon is easily compensated for by designing the reactor to have sufficient excess positive reactivity to overcome the negative reactivity due to the xenon. Now the regulating system must be capable of controlling the excess positive reactivity when there is no xenon present (eg, startup after a long shutdown). This is most commonly done by dissolving a poison (boron or gadolinium) in the moderator and removing it as the xenon builds up. This addition of poison to the moderator on startup is called Xenon Simulation.

As you may suspect, the buildup to and presence of Equilibrium Xenon does not present a significant problem in the operation of our reactors. However, the transient behaviour of xenon creates a major obstacle to operation.

### Transient Xenon Behaviour

Assume a reactor has been operating at 100% power long enough for xenon to have reached equilibrium. If power is rapidly reduced to essentially 0%, what happens to the xenon concentration? To answer this question we shall examine the differential equation which describes the time behaviour of xenon.

$$\frac{dN_{Xe}}{dt} = \underbrace{\gamma_{Xe} \Sigma_f \phi}_{5\%} + \underbrace{\gamma_I N_I}_{95\%} - \underbrace{\gamma_{Xe} N_{Xe}}_{10\%} - \underbrace{\sigma_a^{Xe} N_{Xe} \phi}_{90\%}$$

The percentages shown are the relative magnitudes of the production and loss terms prior to the decrease in power. When power is reduced to 0%, the small production term ( $\gamma_{Xe} \Sigma_f \phi$  - direct fission production) and the large loss term

( $\sigma_a^{Xe} N_{Xe} \phi$  - burnup) both cease. Since the major production

term ( $\lambda_I N_I$  - decay of iodine) continues the concentration of xenon starts to increase. The increase can't go on forever since there is a limited supply of iodine, thus the xenon peaks and eventually decays away. This is shown graphically in Figure 4.

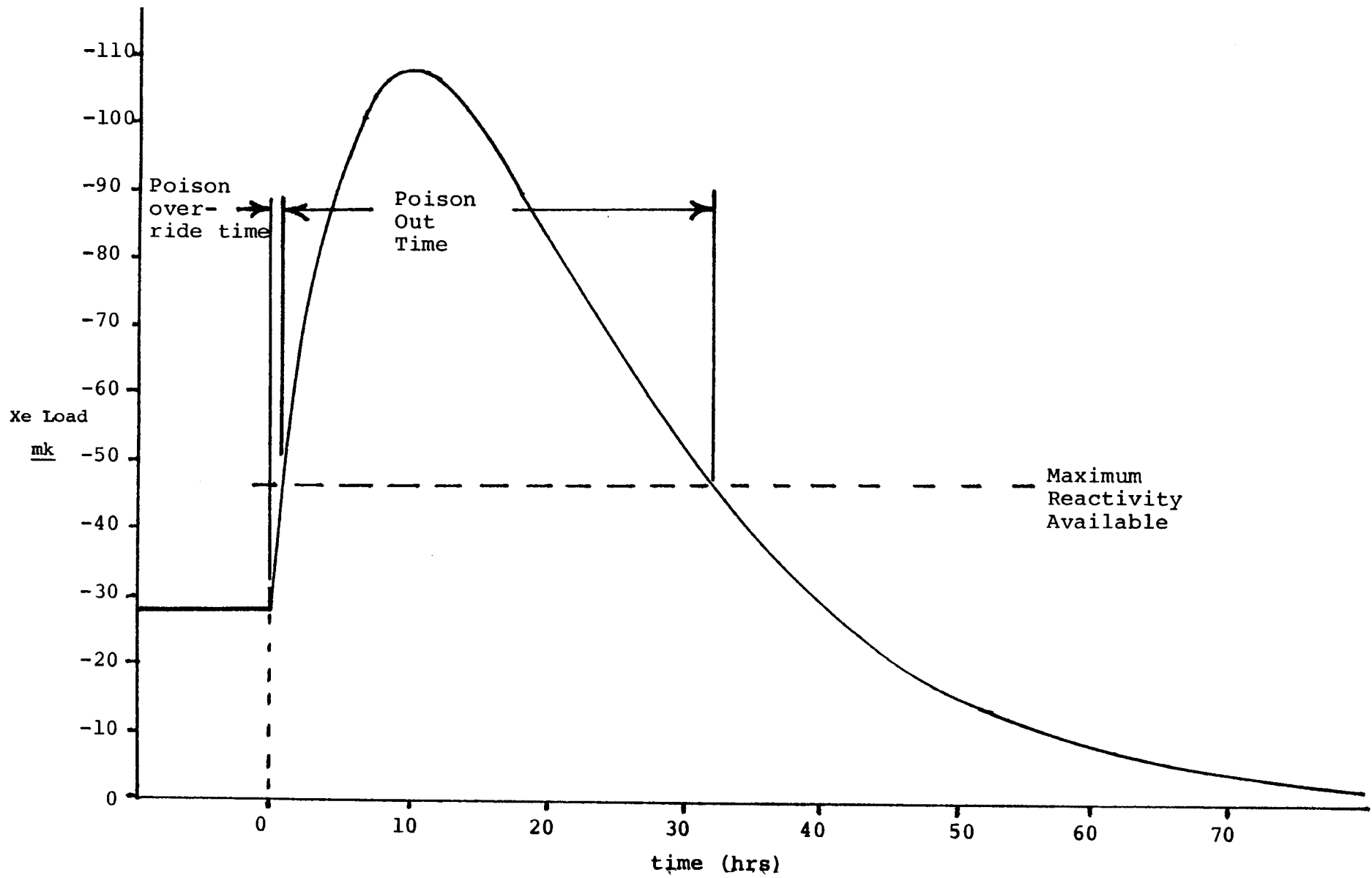

Behaviour of Xenon Load after a trip from full power.

Figure 4

The height of the peak above the equilibrium load turns out to be almost directly proportional to the flux before the trip, providing that equilibrium conditions had been set up by them. Consequently, although the equilibrium xenon loads differ only marginally for our reactors, the xenon transients do not. They are roughly the same for Pickering, Douglas Point, and Bruce with a transient peak about 80 mk above the equilibrium xenon load. At NPD it is merely 22 mk. The different values are due to the different fluxes in these reactors.

The rate of rise of the xenon load after a trip is also a function of the equilibrium conditions before the trip. In our reactors, it is typically around 24 mk per hour for a trip from full power. If a reactor has a maximum available reactivity of, say, 18 mk, you can see that it must be brought back to full power within 45 minutes (the *poison override time*) to burn the xenon out, otherwise it wouldn't be possible to start up again until the xenon transient has passed through its peak and decayed. If this happens, the reactor is said to have *poisoned out*. The *poison out time* may be as high as 32 hours. Obviously, this represents a loss of 32 hours worth of power production.

The desired reactivity for poison override may be provided in a number of ways. The most common are to either remove *adjusters* normally in the core, or to insert *boosters* into the core. Designing a reactor to have a longer override time than is needed costs money; in the first case as reduced fuel burnup and in the second as increased capital cost. In practice the cost of providing the excess reactivity is usually optimized with respect to the energy production that would otherwise have been lost during the poison out time.

So far, we have only discussed the xenon transients occurring after a shutdown from full power equilibrium conditions. In practical reactor operation, we are also interested in the transients after a shutdown from less than full power, and after a step reduction in power. Solving the corresponding xenon equations is a laborious chore and computer codes are normally used. Figures 5, 6, and 7 show the results of such calculations for Douglas Point, for example. These results were taken from the Douglas Point Design Manual, and as far as can be ascertained, they appear to be essentially in agreement with what happens there in practice.

Fig. 5 - shows the transients for 20, 40, 50, 80 and 100% power reductions from initial full power. For a reduction of, say, 40% (ie, from 200  $\rightarrow$  120 MW), the xenon

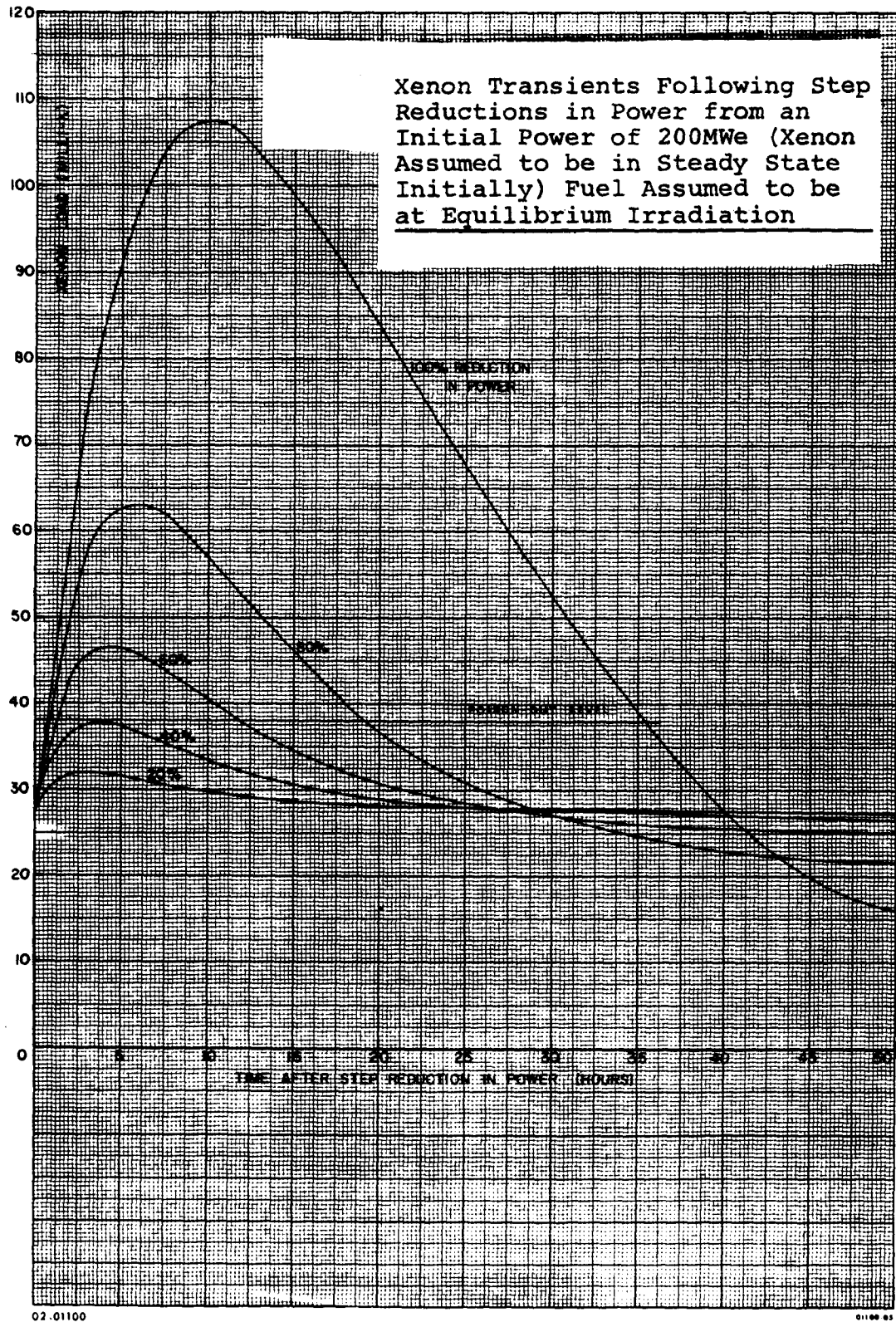
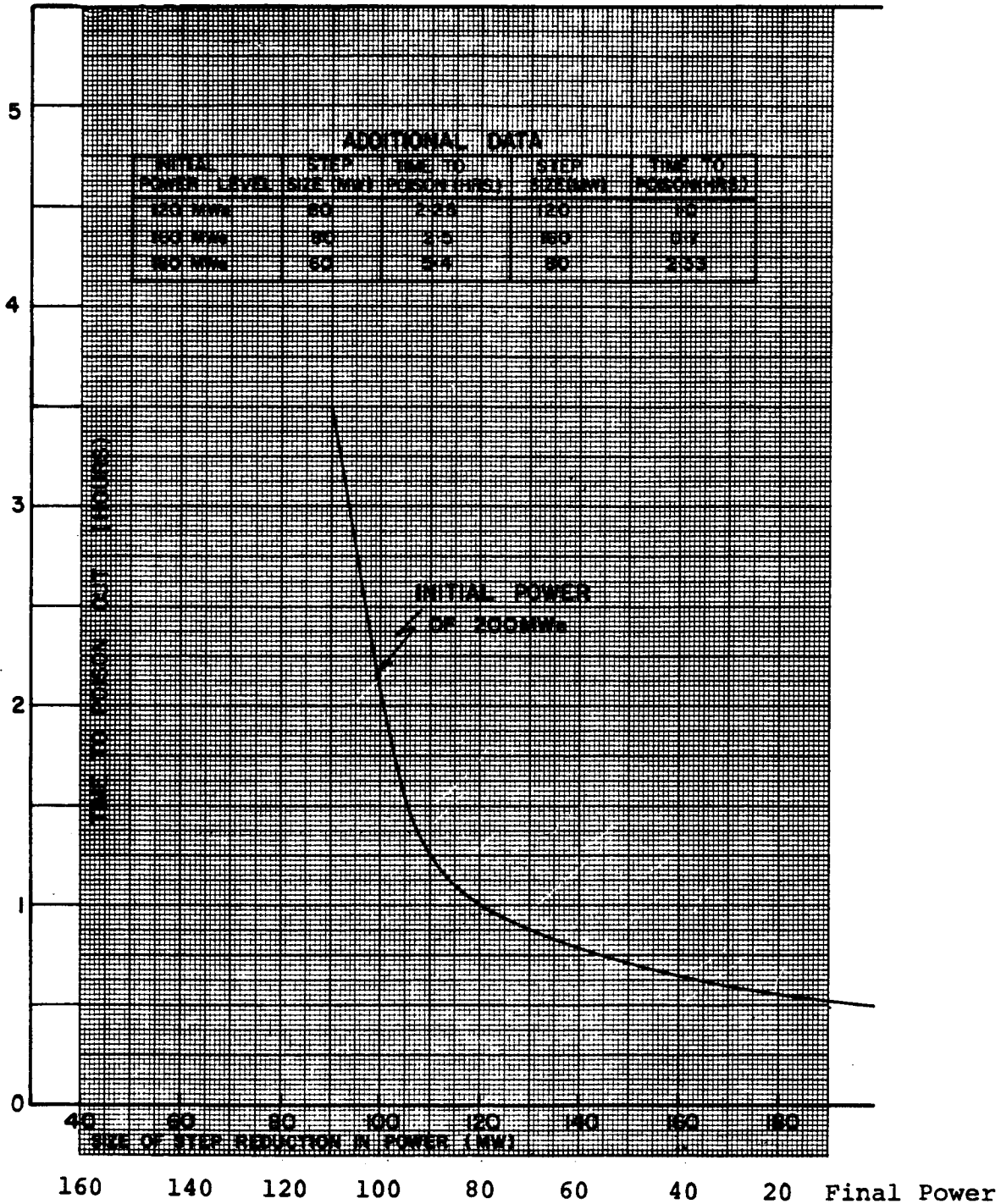
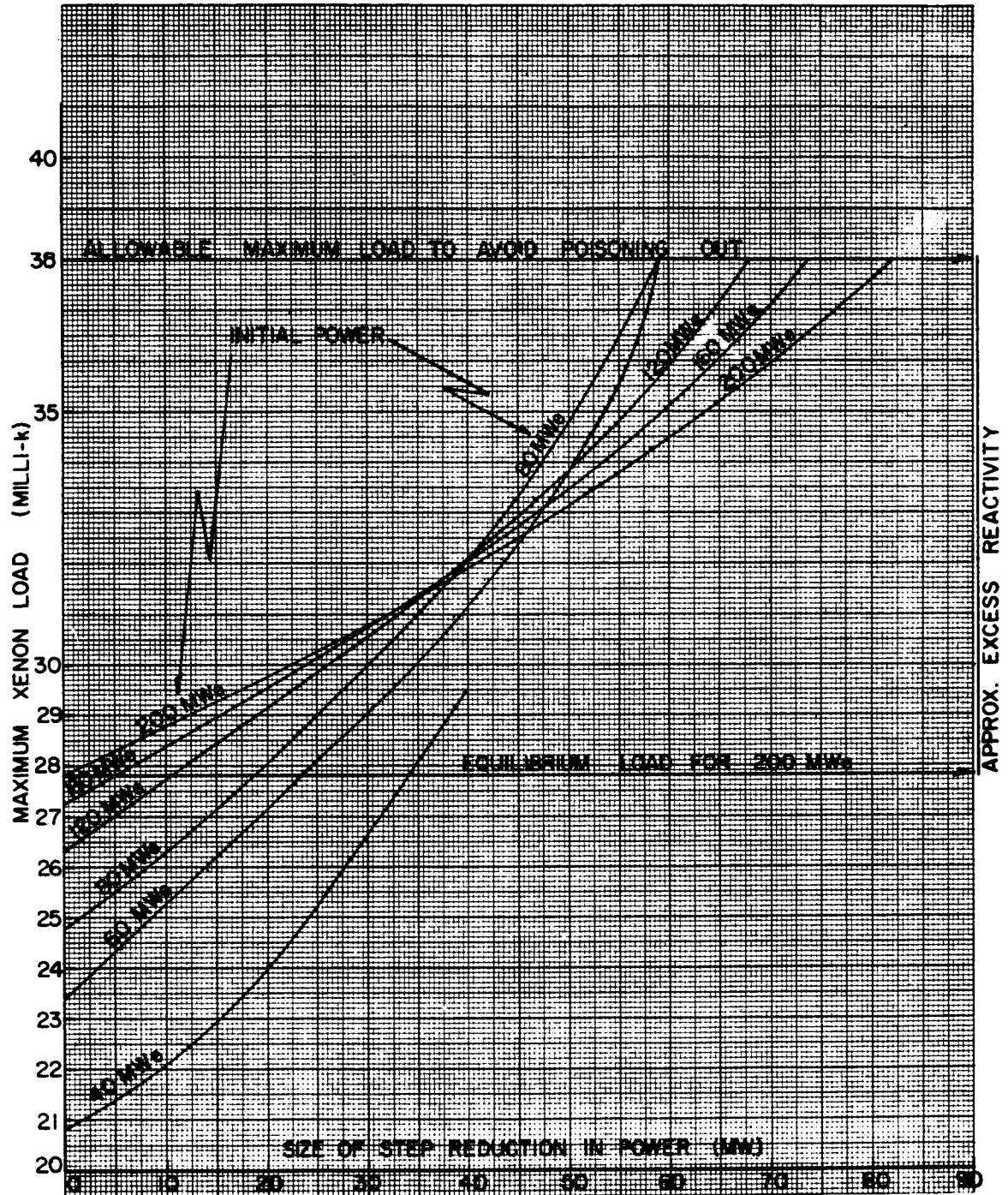

Figure 5



Time to Poison Versus Size of Step Reduction in Power from an Initial Power Level of 200 MWe. Values for Other Initial Power Levels are Shown in Tabular Form. Fuel Assumed to be at Equilibrium Irradiation.



Maximum Xe load attained during the transient following step reductions in power from various initial power levels. (Xenon Assumed to be at the Corresponding Steady State Value Initially; Fuel Assumed to be at Equilibrium Irradiation).

Figure 7

removal by neutron capture will also decrease by 40% from its full power value, but because xenon is still being removed the transient will not reach its shut-down peak. Looking at the figure, you will see that for a 40% reduction the available excess reactivity of 10 mk is just sufficient to override the transient altogether. Ultimately equilibrium will be restored and the xenon load will then be that corresponding to 60% of the full power flux. The figure *also shows that the rate of xenon build-up is less for a 60% reduction than for a 100% reduction, and that the poison override time would therefore be longer.*

Fig. 6 - shows that this is true, namely that for a fixed amount of excess reactivity the poison override time depends on the size of the power reduction. For example, the curve shows that for a reduction of 120 MWe this time will be 1 hour, but it will be twice that for a reduction of 100 MWe.

Fig. 7 - shows the maximum xenon loads reached during the transient following step reductions from various initial power levels. For example, if the reactor is operating at 160 MWe and is then taken down to 100 MWe, the xenon load will increase from 27.2 mk to 35.1 mk. With 10 mk excess reactivity there should be no problem, but without looking at curves like this you wouldn't know whether there would be.

The converse to these curves also applies. For example, if the reactor is running at 140 MWe (at equilibrium) and it is taken to 200 MWe, the immediate effect will be a gain in reactivity due to increased burnup of xenon. At the same time more iodine will be produced which will not show up as extra-xenon production until later on. As a result, the curve will run through a minimum, and then the xenon production will increase because of the increasing amount of iodine that is decaying. Eventually, the xenon concentration will attain the new equilibrium value corresponding to operation at 200 MW. The whole process is shown schematically in Fig. 8, and it does not normally present any operational problems.

### Xenon Oscillations

So far, we have assumed that the xenon poisoning and reactivity loads apply to the reactor as a whole. No mention has been made of the possibility of localized changes in xenon poisoning which can have a very important effect on reactor stability.



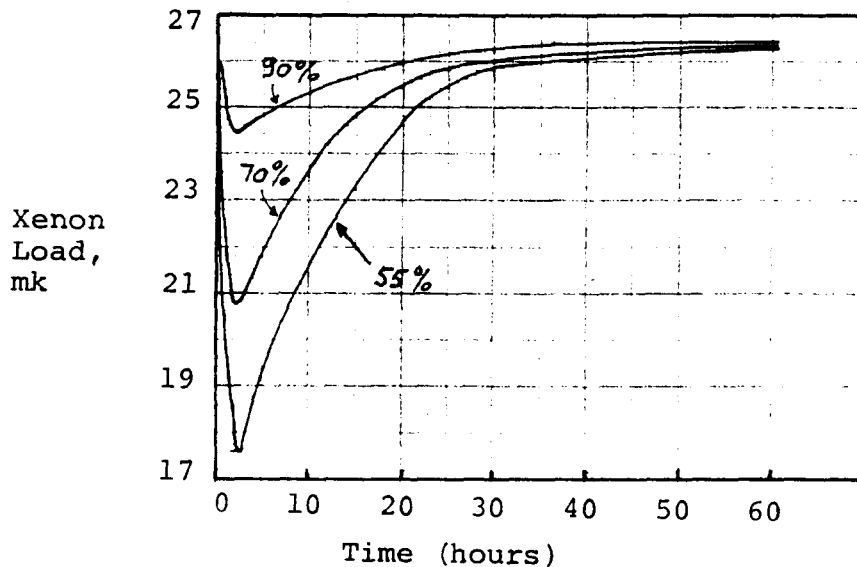

Xenon Transient Following Step Load Increase From Various Initial Powers to 100% Final Power.

Figure 8

For example, let us consider a reactor that has been operated at power long enough for the iodine and xenon concentrations in the fuel to have reached equilibrium.

Suppose now that without changing the total power of the reactor, the flux is increased in one region of the reactor and simultaneously decreased in another region. This change from the desired normal distribution is called a *flux tilt*. This may happen, for example, if control rods or similar mechanisms are inserted into one region and at the same time withdrawn from another. In the region of increased flux, the xenon now burns out more rapidly than it did prior to the change, and its concentration decreases. This decrease in xenon concentration leads to a higher reactivity in this region, which, in turn, leads to an increased flux. This again leads to increased local xenon burnup, increased local reactivity, increased flux, and so on.

Meanwhile, in the region of decreased flux, the xenon concentration increases due to its reduced burnup and to the continued decay of the existing iodine which was produced in the original, higher flux. This increased xenon concentration decreases the reactivity in this region, which reduces the flux, in turn, increasing the xenon concentration, and so on. The thermal flux, and hence the power density, thus decreases in this region while it increases in the other, the total power of the reactor remaining constant.

These local power excursions do not continue forever. In the region of increased flux, the production of xenon from the decay of iodine, which is now being formed more rapidly in this region, ultimately reduces the reactivity there and the flux and power eventually decrease. Likewise, in the region of reduced flux, the accumulated xenon eventually decays, increasing the local reactivity and reversing the flux and power transient in that region.

In this way, the flux and power of a reactor may oscillate between different regions (end to end or side to side) unless action is taken to control them. Calculations, fortunately too lengthy to be spewed out here, show that these *xenon oscillations* have a period of from about 15 to 30 hours.

Xenon oscillations can only occur in large reactors. The argument to show this is as follows:

If the neutrons produced in one region of the reactor do not cause significant fissions in another region, then the two regions can act independently of one another. The criterion that determines whether or not this is possible is the degree of neutron leakage from the one region to the other. In a reactor such as NPD the core is small enough to permit a disturbance started in one region to have an effect in another region. The xenon and flux changes would therefore affect the whole core and a regulating system based on flux measurements in one locality can correct the flux disturbance and prevent xenon oscillations from being initiated.

If the reactor is large, leakage of neutrons between regions is very small. A disturbance started in one region has little effect in another region. Thus, if a flux increase occurs due to a fuel change in one region, for example, a non-regional regulating system would compensate for this and maintain steady power by lowering the flux in another region to keep the average flux across the core constant. This would set up a xenon oscillation in the second region exactly out of phase with that in the first region.

Furthermore, it is obvious that xenon oscillations can only occur if the flux is high enough for xenon burnup to be as pronounced as xenon decay.

These two conditions for the presence of xenon oscillations (ie, large reactor size and high flux) are satisfied for most power reactors. Since xenon oscillations can occur at constant power they may go unnoticed unless the flux and/or power density distributions are monitored at several points in the reactor. This must be done in order to prevent such oscillations, since they represent something of a hazard to the safe operation of a reactor. Conceivably, they may lead to dangerously high local temperatures and even to fuel meltdown.

In any event, these oscillations, if permitted to continue, burden the core materials with unnecessary temperature cycling which may result in premature materials failure.

One of the purposes of the regional absorber rods at Douglas Point, and of the regional liquid zone control systems at Pickering and Bruce, is to prevent such xenon oscillations. For example, at Pickering the reactors are subdivided into 14 regions (called zones), and each region has flux detectors whose output is used to adjust the amount of light water absorber in the zone control compartments.

### Samarium-149

Sm-149 is the most important of the stable fission products. It is formed in the fuel by the decay of fission product neodymium-149 and promethium-149:

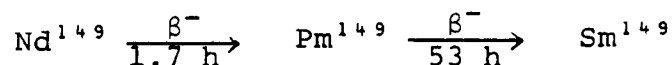

Since Sm-149 is stable, the only removal process for it is neutron capture. The Sm-150 formed has a low absorption and is therefore insignificant. Sm-149 has a much lower cross section ( $4.2 \times 10^{-4} \text{b}$ ) than Xe-135, it will take correspondingly longer for equilibrium to be reached. The half-life of neodymium is so short compared to promethium that we lump its fission product yield with promethium. Note that there is no direct production of samarium from fission. As with xenon we need two equations to describe the behaviour:

$$\frac{d}{dt} N_{\text{Pm}} = \underbrace{\gamma_{\text{Pm}} \Sigma_f \phi}_{\text{Production from fission}} - \underbrace{\lambda_{\text{Pm}} N_{\text{Pm}}}_{\text{Loss due to decay}}$$

$$\frac{d}{dt} N_{\text{Sm}} = \underbrace{\lambda_{\text{Pm}} N_{\text{Pm}}}_{\text{Production from decay of Pm}} - \underbrace{\sigma_a^{\text{Sm}} N_{\text{Sm}} \phi}_{\text{Loss due to burnup}}$$

where:  $\gamma_{Pm}$  = Fission Product Yield of Promethium  
 $\Sigma_f$  = Fission Cross Section of the Fuel  
 $\phi$  = Average Neutron Flux  
 $\lambda_{Pm}$  = Decay Constant of Promethium  
 $N_{Pm}$  = Number Density of Promethium  
 $N_{Sm}$  = Number Density of Samarium  
 $\sigma_a^{Sm}$  = Cross Section of Samarium

The equilibrium Pm-149 concentration is:

$$N_{Pm} = \frac{\gamma_{Pm} \Sigma_f \phi}{\lambda_{Pm}}$$

Just as with iodine-135, the equilibrium concentration of Pm-149 is a direction function of the power level.

The equilibrium concentration of Sm-149 is:

$$N_{Sm} = \frac{\gamma_{Pm} \Sigma_f}{\sigma_{sm}}$$

Note that equilibrium samarium is independent of the flux level. Equilibrium Samarium Load is around -5.5 mk and it takes about 300 hours of operation to reach equilibrium for our reactors (time to reach equilibrium is a function of the flux level).

#### Samarium Growth After Shutdown

After a shutdown the samarium concentration will increase since none is being burned out and some is still being produced by the decay of Promethium. The maximum Samarium Load after shutdown depends on the promethium concentration prior to shutdown. For our larger reactors the maximum Samarium Load is about 12 mk. The buildup is shown in Figure 9.

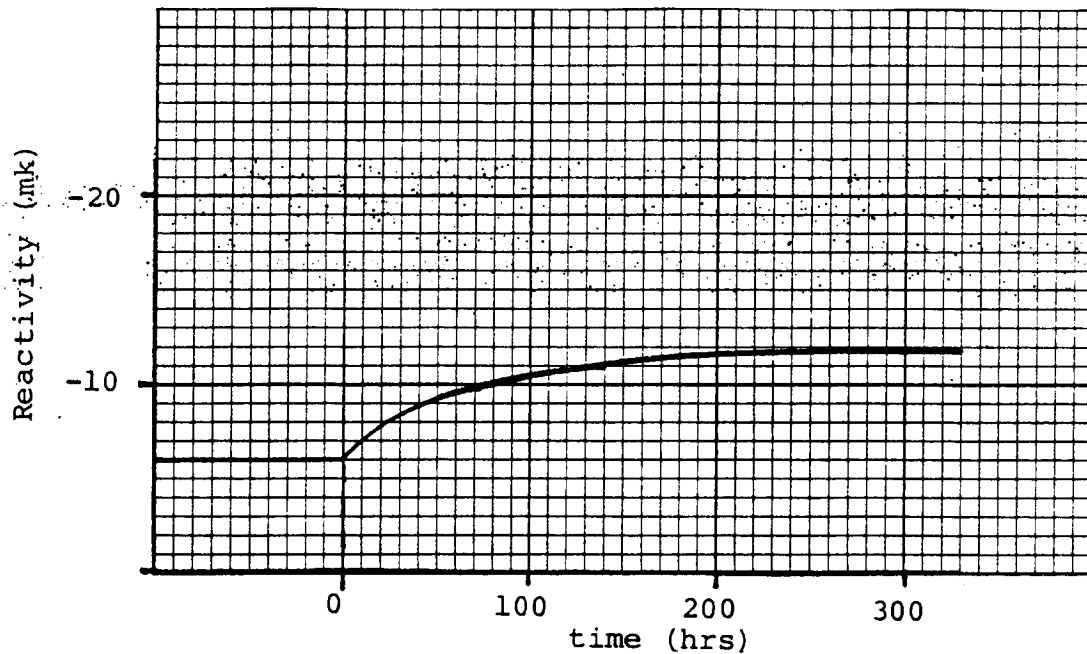

Figure 9

It is interesting to note that although the equilibrium samarium load has to be allowed for in reactor design, the shutdown load may be ignored. There are two reasons for this.

- (1) By looking at the time scale of Fig. 9 you will realize that the maximum samarium load will not appear until the xenon transient has long been and gone. There will therefore be lots of reactivity available. You can also see that the increase in samarium load during the xenon poison override time is negligible, so that this doesn't present a problem either.
- (2) The rate at which the samarium is formed is governed by the Pm-149 half-life of 53 hours, and it corresponds almost exactly to the rate at which Pu-239 is formed after a shutdown. (Pu-239 is still produced from Np-239 decay, but it is not being used up since there are no neutrons). It turns out that the increased reactivity from this plutonium transient more than compensates for the increased samarium load. The net change after shutdown is about +6 mk due to combined effect of samarium and plutonium.

ASSIGNMENT

1. Write the equations for the time rate of change of  $N_{Xe}$  and  $N_I$ . Explain what each term represents and give the magnitudes of the terms. Note the conditions under which these magnitudes are applicable.
2. Explain why equilibrium Xenon Load changes very little when power is raised from 50% to 100%.
3. Explain why peak xenon after shutdown from 100% equilibrium will be nearly twice what it is after shutdown from 50% equilibrium.
4. Give and explain the conditions required for a xenon oscillation to occur.
5. Define Iodine load and explain its significance.
6. Explain why samarium growth after shutdown may be neglected in reactor design.

J.U. Burnham  
J.E. Crist

## Nuclear Theory - Course 227

REACTIVITY EFFECTS DUE TO TEMPERATURE CHANGES

---

In the lesson on reactor kinetics we ignored any variations in reactivity due to changes in power. As we saw in the previous lesson there are marked changes in reactivity due to xenon; occurring over a period of minutes to hours after an overall power change. Changes in reactor power causes changes in the temperature of the fuel, moderator, and coolant. These also have an effect on reactivity which is more rapid than xenon effects.

The NRX Experiment

In 1949, the NRX reactor at AECL, Chalk River, was allowed to "run away". NRX is a heavy water moderated reactor which uses control rods for reactor regulation. The heavy water level was set 3 cm above the height at which the reactor would be critical at low power with the rods withdrawn. The reactor power was allowed to increase unchecked, and the manner in which it increased is rather unexpected (see Figure 1).

The power initially increased exponentially with a period of 33 seconds ( $T = 33 \text{ s}, \Delta k = +1.6 \text{ mk}$ ). However, it did not increase indefinitely as you might have expected. As the temperature of the fuel rods increased, the reactivity decreased and this caused the rate of power increase to slow down. Later the reactivity decreased at a faster rate as the heavy water got warmer. The total decrease in reactivity was enough to make the reactor subcritical, and the end result was that the power reached a maximum value and then started to decrease.

Thus the reactor is self-regulating with temperature increases preventing the power from continuing to increase. Of course, in this experiment the initial excess reactivity was quite small; if more reactivity had been inserted initially it is quite possible that the power would have continued to rise. The point of this example is not to demonstrate that reactor power would never increase continuously (it well might), but to show that there was a loss in reactivity due to the increase in the temperatures of fuel and heavy water.

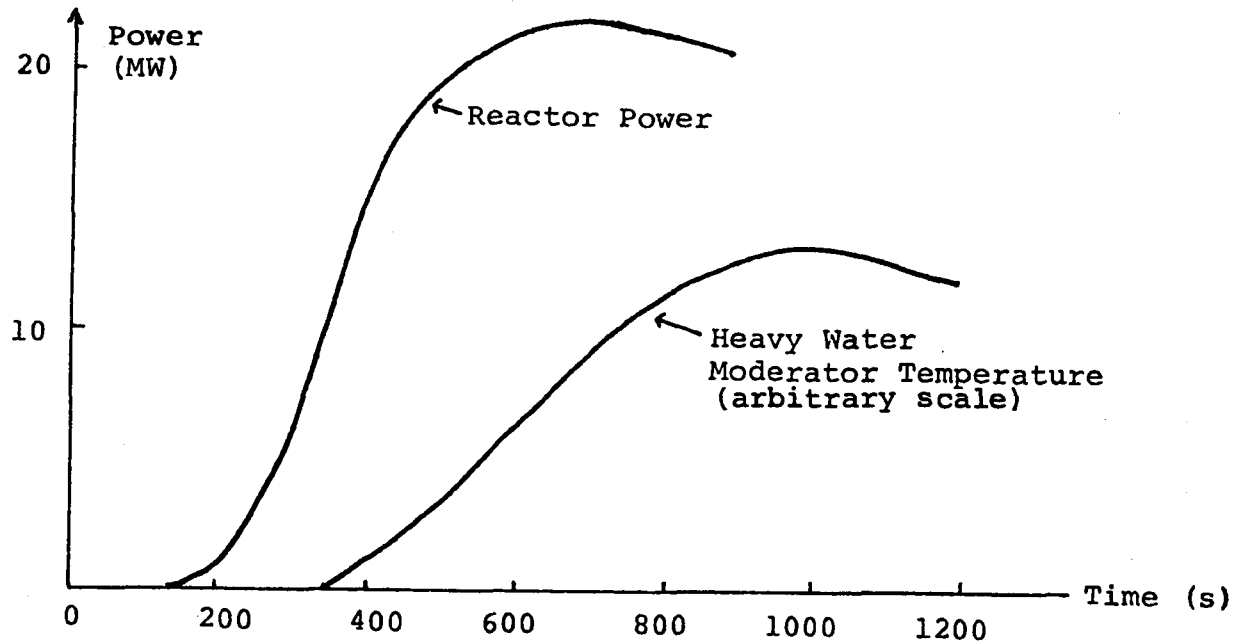

Fig. 1 The NRX Experiment

The *temperature coefficient of reactivity* is defined as the change in reactivity per unit increase in temperature. Its units are  $\text{mk}/^\circ\text{C}$ .

The coefficient may be positive or negative. In the example just described it was negative, because an increase in temperature led to a loss of reactivity.

Temperature changes occur, more or less independently, in the fuel, the heat transport system and the moderator, and there will therefore be a temperature coefficient of reactivity associated with each of these. It is very desirable for the overall temperature coefficient of a reactor to be negative to provide the self-regulating feature illustrated by NRX.

In order to fully understand why changes in temperature cause changes in reactivity it is necessary to understand both the physical and nuclear properties which change with temperature.

(a) Thermal Expansion Effect

As the temperature of the coolant and/or moderator increases its density decreases. As a result neutrons travel further thus, they have an increased probability of escaping ( $\Lambda_f$  and  $\Lambda_{th}$  may both decrease). Also with fewer moderator molecules there is less absorption in the moderator and thermal utilization ( $f$ ) increases.



(b) Direct Nuclear Effect

This is the effect commonly known as *Doppler Broadening*. We mentioned earlier in the course that resonance capture occurs in U-238 for certain neutron energies related to the target nucleus which was assumed to be at rest. The resonance is actually determined by the relative velocity of the neutrons and the target nuclei. When the fuel gets hot, the uranium atoms will vibrate more vigorously. A neutron which would have been outside the resonance peak if the uranium atoms had been at rest, may encounter an atom moving at the necessary speed to put their relative velocity in the resonance peak. Thus the neutron, which might have survived in cold fuel, is now captured in hot fuel, and this is reflected in a spreading of the resonance peak as shown in Figure 2. There will then be a decrease in the resonance escape probability  $p$  and in the reactivity due to this so-called Doppler Broadening of the resonance peak\*.

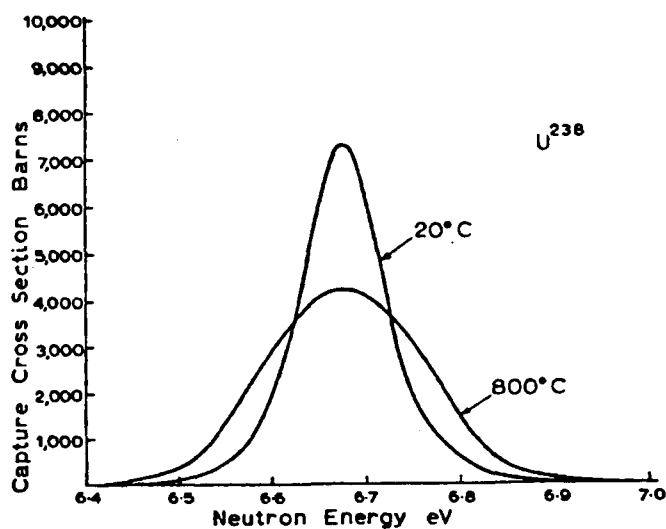

Fig. 2 Doppler Broadening

\*Without a rigorous mathematic treatment it may not be easy to convince you that although the area under the curve is the same, the absorption increases. A simple (but basically correct) approach is to say that although  $\sigma_a$  for hot fuel is only half of what it is for cold fuel, it is high enough to virtually guarantee absorption of any resonance energy neutrons entering the fuel. Only now the resonance energy range has been doubled.

(c) Indirect Nuclear Effect

A thermal neutron is one which is in thermal equilibrium with its surroundings. Clearly then any change in the temperature of the moderator, coolant, or fuel will affect the average thermal neutron energy. Thus neutron cross sections, being energy dependent, are affected. This may affect the thermal utilization ( $f$ ) and the reproduction factor ( $\eta$ ). Generally the changes in  $\eta$  which are most significant, are due to changes in the ratio of the fission cross section to the absorption cross section of the fissile material ( $\sigma_f/\sigma_a$ ).

Figure 3 shows the variation of  $\eta$  for  $U^{235}$  and  $Pu^{239}$ . Note in particular that around 0.3 eV,  $\eta$  for  $Pu^{239}$  starts to rise rapidly

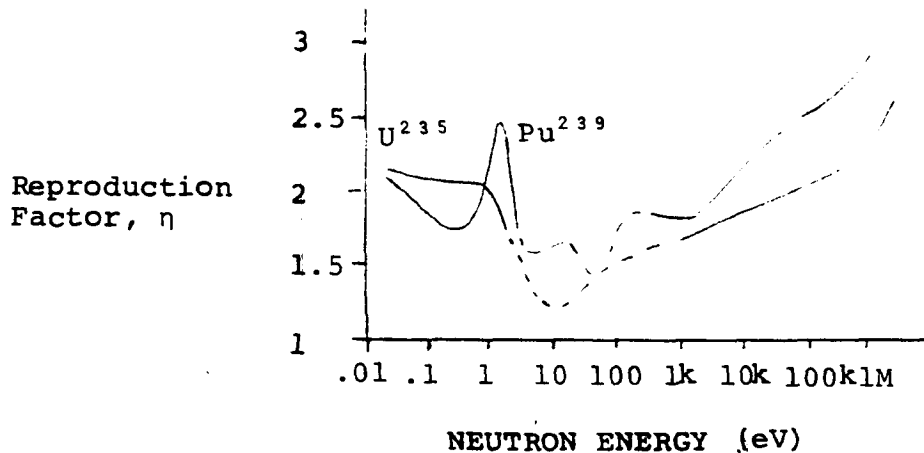

Figure 3

To evaluate the magnitude of the effects mathematically the Design Manuals evaluate the derivative of  $k$  with respect to temperature

$$\frac{dk}{dT}$$

$$k = \epsilon p \eta f \Lambda_f \Lambda_t$$

$$\frac{1}{k} \frac{d}{dT} k = \frac{1}{\epsilon} \frac{d\epsilon}{dT} + \frac{1}{p} \frac{dp}{dT} + \frac{1}{\eta} \frac{d\eta}{dT} + \frac{1}{f} \frac{df}{dT} + \frac{1}{\Lambda_f} \frac{d\Lambda_f}{dT} + \frac{1}{\Lambda_t} \frac{d\Lambda_t}{dT}$$

The change in each of the factors is tabulated in Table I for both fresh and equilibrium fuel. We will now look at the temperature coefficients for the fuel, moderator and coolant.

### Fuel Temperature Coefficient

There are two primary effects due to an increase in the fuel temperature:

- 1) Increased resonance absorption
- 2) An altered ratio of fission to absorptions in the fuel.

Let us look at a concrete example. Table I gives makeup of the fuel temperature coefficient for the Pickering units at nominal operating conditions.

From this table you can see that the predominant term is the resonance capture term. It is sufficiently large to ensure an overall negative fuel temperature reactivity effect at nominal operating conditions, and it therefore provides the self-regulating feature that is so desirable.

TABLE I

#### Fuel Temperature Coefficient For Pickering Units 1-4

(Nominal Operating Conditions. Units are  $\mu\text{k}/^\circ\text{C}$ )

	Fresh Fuel	Equilibrium Fuel
$(1/\epsilon) d\epsilon/dT$	0	0
$(1/p) dp/dT$	-9.33	-9.29
$(1/f) df/dT$	-0.79	+0.34
$(1/\eta) d\eta/dT$	-4.04	+5.33
$(1/\Lambda_f) d\Lambda_f/dT$	0	0
$(1/\Lambda_t) d\Lambda_t/dT$	-0.83	-0.43
TOTAL	-14.99	-4.05

The resonance escape term  $\left( \frac{1}{P} \frac{dP}{dT} \right)$  is negative

because increasing the fuel temperature causes increased resonance capture due to doppler broadening. Fresh and

equilibrium fuel values are the same because the amount of  $U^{238}$  in the reactor is essentially constant.

The reproduction factor term  $\left(\frac{1}{\eta} \frac{d}{dT} \eta\right)$  is negative for fresh fuel because the fissile material is all  $U^{235}$  and  $\eta$  decrease with increasing temperature in the  $U^{235}$  for energies of interest ( $< 1$  ev) as shown in Figure 3. For equilibrium fuel this term is positive due to the increased concentration of  $Pu^{239}$ . The increase in  $\eta$  with temperature for  $Pu^{239}$  overwhelms the negative effect of the uranium.

The behavior of the thermal utilization term is also due to the increased concentration of plutonium. (The plutonium increases at 80% of the uranium 235 depletion. Thus  $0.8 \times 741.6 = 593 \text{ b} > 580 \text{ b}$  the cross section for U235.)

The change in thermal leakage is due to an increase in the distance a thermal neutron diffuses, which is brought about by an overall reduction in the thermal absorption cross section of the whole core.

#### Heat Transport Temperature Coefficient of Reactivity

The reactivity effect associated with a change in coolant temperature is rather more complicated in its make-up than the fuel temperature effect, and we won't discuss it in detail.

Figure 4 shows the overall coolant temperature coefficient of reactivity for the Pickering units as calculated from the design data. It is very difficult to determine it from measurements, because you can't change the coolant temperature without changing the fuel temperature. It is however positive.

Figure 5 shows the results of measurements made on Pickering Unit 3 when it contained fresh fuel. The heat transport system was heated by running the primary pumps while the reactor was held critical at 0.1% of full power. The measurements extended over a period of 13 hours so that one must assume that the fuel temperatures kept in step with the coolant temperatures. The measured changes in reactivity therefore reflected both the fuel and the heat transport coefficients of reactivity, and you can see that the negative effect of the former more than compensates for any positive effect of the latter. The reactivity change is seen to be  $-7 \text{ mk}$  from cold shutdown to hot shutdown.

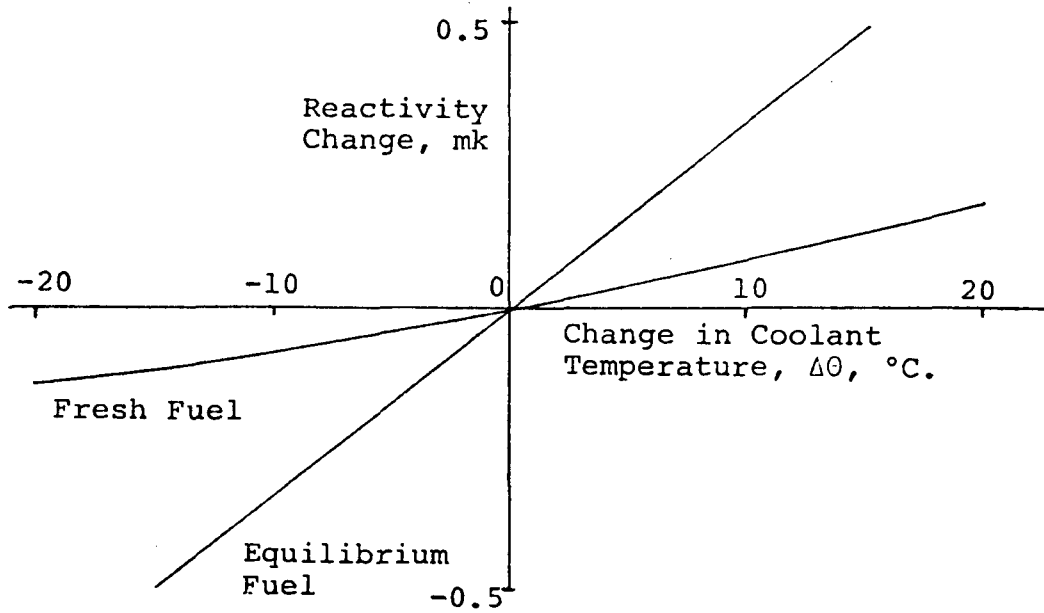

Calculated Change in Reactivity Versus Change in Coolant Temperature (Pickering Units 1-4)

Figure 4

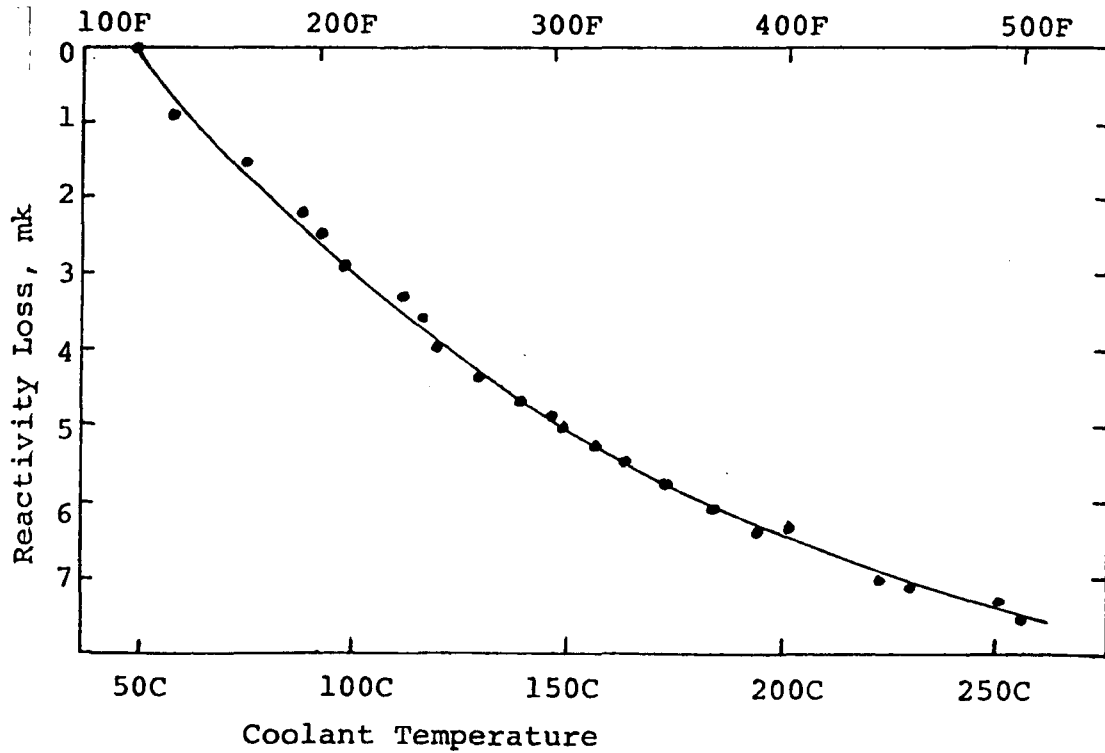

Reactivity Loss Versus Coolant Temperature  
(Pickering Unit 3, Fresh Fuel)

Figure 5

Moderator Temperature Coefficient of Reactivity

As with the fuel temperature coefficient there are two effects; change in moderator density and increasing average thermal neutron energy. The temperature of the moderator affects the neutron energy much more than coolant or fuel does - it is the base temperature, so to speak. One would therefore expect the magnitude of the moderator coefficient to be greater than the other two, and this is in fact the case, as you can see from Table II which again gives the values applicable to Pickering.

TABLE IIModerator Temperature Coefficient for Pickering Units 1 - 4

(In units of  $\mu\text{k}/^\circ\text{C}$ , calculated for  $\Delta T = -13^\circ\text{C}$ )

	Fresh Fuel	Equilibrium Fuel
$(1/\epsilon) d\epsilon/dT$	0	0
$(1/p) dp/dT$	-24.0	-23.9
$(1/f) df/dT$	55.4	67.1
$(1/\eta) d\eta/dT$	-59.2	76.0
$(1/\Lambda_f) d\Lambda_f/dT$	-13.0	-13.0
$(1/\Lambda_t) d\Lambda_t/dT$	-28.7	-22.0
TOTAL	-69.5	+84.2

The change in moderator density is responsible for an increase in the distance a neutron travels in slowing down. This in turn leads to a decrease in the resonance escape probability,  $p$ , as well as in the fast non-leakage probability.

The distance a neutron diffuses also increase. It is not only affected by the change in moderator density, but also by the reduction in all the absorption cross sections with increasing thermal energy. Consequently, the change in thermal leakage is greater than that in fast leakage.

The great changes in the value of  $\eta$  from fresh to equilibrium fuel are due to the effects of the ratio of fission to absorption in  $\text{Pu}^{239}$  and  $\text{U}^{235}$  as previously stated.

The thermal utilization term is always positive due to a decrease in absorption by the moderator associated with a decrease in moderator density.

### Practical Aspects

We have already mentioned that it is desirable for the temperature coefficients to be negative so that a self-regulating feature is provided. However, more must be considered than just the values of the three temperature coefficients. Two most important additional factors are; the size of the various temperature changes for a given power change, and the time period over which the changes occur.

Typically, in a change from hot shutdown, to 100% power, the average coolant temperature may increase by  $\approx 20 - 40^\circ\text{C}$  while the average fuel temperature will increase by 500 to  $600^\circ\text{C}$  and the moderator temperature will be maintained constant. Furthermore, the fuel temperature will change nearly instantaneously as the power changes while the coolant temperature change will lag the power change by a few seconds.

Thus, we achieve the desired self-regulation merely by having a negative fuel temperature coefficient of reactivity.

A negative temperature coefficient does, however, create some problems. In heating the fuel and coolant from a cold shutdown condition to a hot shutdown condition there is a net loss of reactivity worth which can be as much as 9 mk. Also, when power is increased there is a reactivity loss which must be compensated for. In Ontario Hydro, this is expressed in terms of the *power coefficient*, which is defined as the reactivity change in raising power from hot shutdown to 100% full power. It only includes the temperature coefficients of reactivity, and not any reactivity loss due to fission product formation. It is typically of the order of 5 or 6 mk for a heavy water reactor.

### Effects Due to Void Formation

Voids will be formed if either the moderator or the heat transport system fluid boils. Void formation in the coolant is of more concern than in the moderator, and so we'll restrict our discussion to the effects of loss of coolant.

Because the reactivity increases with loss of liquid coolant, knowledge of the magnitude of this effect is important for safety reasons.

The liquid coolant may boil as a result of:

- rupture of the feeder pipe(s)
- failure of the primary pump(s)
- large power excursions
- channel blockage.

Under all these circumstances the coolant will gradually be displaced by steam, and eventually the channel(s) may become totally depleted of liquid coolant. This is frequently called voiding the channel.

The severity of the above emergency conditions depends primarily on the rate of reactivity addition, although the total reactivity addition may be of equal importance. For a light water cooled reactor, such as Gentilly, loss of coolant results in a very large change in reactivity. For example, it is estimated that for Gentilly, operating with fresh fuel, the reactivity change for a loss of coolant in half the core can be as high as 37 mk, depending on the operating conditions at the time. This colossal change is of course primarily due to the increase in the thermal utilization,  $f$ , caused by the loss of  $H_2O$  absorber.

For  $D_2O$  cooled reactors, the effects are nowhere near as drastic, although they are still very important.

Voiding of fuel channel causes a decrease in the moderation of neutrons in the immediate neighborhood of the fuel elements. Looking at figure 6 (a quadrant of a fuel bundle) you can see that a neutron born in one fuel element (eg, element 'A') normally passes through some coolant before reaching the next fuel element (element 'B') with the coolant providing a little moderation. With the channel voided there is no moderation hence, higher energy neutrons are interacting with the fuel in element B.

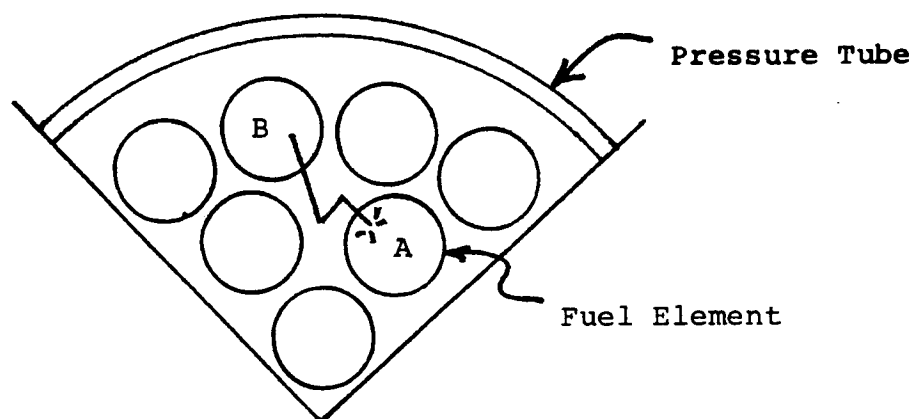

Quadrant of a Fuel Bundle

Figure 6



This has two effects which can be seen by looking at the radiative capture and fission cross sections of  $U^{238}$  shown in Figure 7

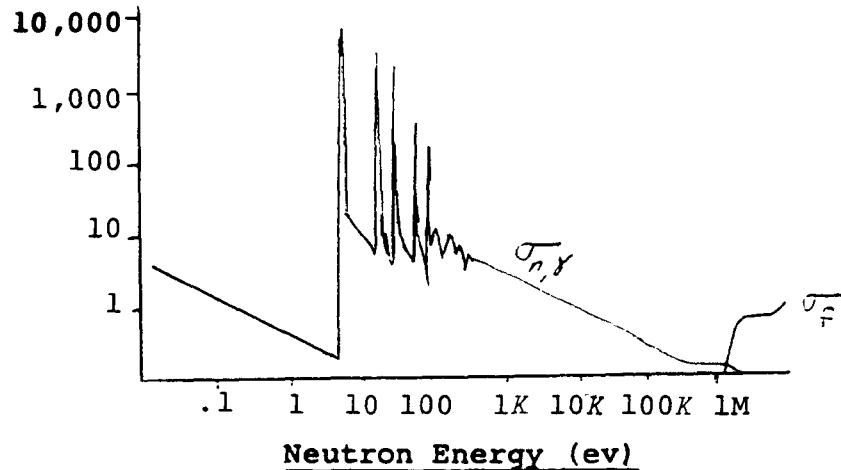

Figure 7

- (a) An increase in the fast fission factor ( $\epsilon$ ) since  $\sigma_f$  increases with increasing energy.
- (b) An increase in the resonance escape probability ( $p$ ) since  $\sigma_{n,\gamma}$  decreases with increasing neutron energy.

Both of these give rise to a positive void coefficient.

Voiding of the coolant also reduces the amount of absorbing material in the reactor, however, for heavy water coolant, this decrease is very small provided the coolant isotopic is high. In practice there is a lower limit on coolant isotopic to prevent an excessively large void coefficient. This lower limit is usually defined in Station Operating Policy and Principles. (eg, 97% at Bruce NGS 'A').

Excessive positive or negative void coefficients are to be avoided if possible. An excessively large positive coefficient will cause large power surges, during the void formation, which are likely to cause severe damage to the reactor if the protective system does not respond enough.

Excessive negative coefficients, on the other hand, cause a rapid decrease in power when the void is formed, which is then corrected for by the regulating system. Then, when the void fills, a power surge again results.

ASSIGNMENT

1. Explain why the fuel temperature coefficient of reactivity is more important than either the coolant or moderator temperature coefficient of reactivity. (Two reasons.)
2. Explain why the fuel temperature coefficient is larger in magnitude for fresh fuel than it is for equilibrium fuel.
3. Cite an example of when the moderator temperature coefficient of reactivity may be useful.
4. Considering only the effect on the void coefficient, explain why it is undesirable to add soluble poison to the coolant.

J.E. Crist

## Nuclear Theory - Course 227

## REACTIVITY CONTROL

Reactivity mechanisms represent the final control elements which cause changes in the neutron multiplication constant  $k$  (or reactivity  $\Delta k$ ) hence, reactor power. There are two separate requirements of the reactivity mechanisms which are preferably fulfilled by two independent systems. These requirements are:

1. Reactor Regulation. The three basis functions of the reactor regulation systems are:
  - a) Maintain  $k = 1$  for steady power operation.
  - b) Provide small changes +ve or -ve in  $\Delta k$  to change reactor power.
  - c) Prevent the development of flux oscillations.
2. Reactor Protection. The principal purpose of the protective system is to rapidly insert a large amount of negative reactivity to shutdown the reactor (TRIP).

From a reactor safety viewpoint it is desirable to have reactor regulation and protection performed by separate systems. From a practical viewpoint no single system can adequately fulfill all the requirements for reactor regulation let alone regulation and protection together.

#### Requirements of Reactivity Mechanisms

As well as independence between (1) and (2) the complex physical and nuclear changes occurring in core during reactor operation mean that an effective regulating system will have to consist of more than one type of reactivity mechanism. A convenient breakdown of the various in core reactivity changes which require compensating/regulating controls is listed in Table 1 and grouped in terms of the most important parameters of any reactivity mechanism namely:

- (i) reactivity worth (or depth)  $\Delta k$  (mk).

This must be somewhat larger than the reactivity change for which the mechanism must compensate or control, and

- (ii) operational time interval.

This is the time period during which the mechanism has to be able to supply or remove reactivity and this will hence determine the reactivity insertion rate (sometimes called the ramp reactivity rate),  $\Delta k$  per unit time (mk/s).

Each of the tabulated reactivity changes is now briefly described and typical  $\Delta k$  worths necessary to adequately control these changes as they occur in our stations are shown for comparison in Table 2. Where these values change from fresh fuel to equilibrium fuel load conditions then the difference is noted.

### In Core Reactivity Changes

#### (a) Power Changes (Ref. Lesson 227.00-12)

Because the temperatures of the fuel and coolant increase as power increases from a hot shutdown condition to a hot full power condition, reactivity changes. Under normal (ie, non excursion) type conditions there will be a negative reactivity worth change called the power coefficient of reactivity. These are tabulated in Table 2. In order to maintain criticality an equal but opposite reactivity worth must be supplied by some other means, (eg, by removing an equivalent reactivity worth from the Zone Control System).

#### (b) Fuel and Coolant Temperature Changes (Ref. Lesson 227.00-12)

As the fuel and coolant are heated from a cold shutdown condition ( $\sim 25^\circ\text{C}$ ) to a hot shutdown condition ( $\sim 276^\circ\text{C}$ ) reactivity decreases, Table 2.

#### (c) Moderator Temperature Changes (Ref. Lesson 227.00-12)

Normally moderator temperature is kept fairly constant (typically  $70^\circ\text{C}$  maximum in the calandria and  $40^\circ\text{C}$  at the heat exchanger outlets) but variation could be obtained by changing the rate of heat removal from the heat exchangers. The accompanying reactivity change is usually negative with increasing temperature for a freshly loaded core but changes to a small positive value at equilibrium fuel burn up as shown in Table 2.

#### (d) Fresh Fuel Burn Up (Ref. Lesson 227.00-7)

From an initial fresh fuel charge to equilibrium fuel burn up there is a large increase in negative reactivity load over a period of 6 - 7 months as a result of build up of long lived neutron absorbing fission products (not including  $\text{Xe}^{135}$ ) and depletion of fissile material. Figures for our reactors are quoted in Table 2. This is a slow but continuous reactivity change.

(e) Equilibrium Fuel Burn Up

At equilibrium fuel burn up, when the operating target excess reactivity has been reached, fission products continue to be built up and fissile material continues to be depleted. Continuous on power refuelling is of course the most important method of compensating for this continual depletion of fissile material at equilibrium burn up. The rate of reactivity loss for our reactors without refuelling is shown in Table 2 and for comparison the reactivity increases due to the refuelling of a single typical central channel are also listed.

(f) Equilibrium Xe Load Build Up (Ref. Lesson 227.00-11)

Following a long reactor shutdown (>2 - 3 days) an equilibrium reactivity load (up to 28 mk see Table 2) will be built up due to  $Xe^{135}$  accumulating in the fuel after start up.

(g) Xe Transient Build Up (Ref. Lesson 227.00-11)

Within 12 hours of a reactor shutdown (or large derating due to operational problems, or a load following situation) there is a very large transient rise in Xe poison concentration (up to -80 mk above the equilibrium level at Pickering, Table 1). To enable us to restart the unit, Xe OVERRIDE or BOOSTING CAPABILITY is provided to compensate for this reactivity loading providing an override time, measured after shutdown, which gives reactivity capability of restarting a unit within this time. Actual reactivities available and the override times thus obtained are listed in Table 2 for all our stations.

(h) Flux Oscillations (Ref. Lesson 227.00-11)

As localized flux/power changes occur in the core (from, for example, refuelling part of a channel or movement of a localized control rod) these can result in quite large undamped power swings (Xenon oscillations) being set up with periods between 15 - 30 hours.

To counterbalance these oscillating unbalanced reactivity loads in various regions (called ZONES) of the core, the ZONE CONTROL system is used. Total reactivity worth of these systems are shown in Table 2, and are actually larger than required to control only the flux oscillations as these systems are also used for bulk power control.

(i) Plutonium and Samarium Build Up (Ref. Lessons 227.00-7&11)

After shutdown plutonium builds up from the decay of neptunium adding positive reactivity and samarium builds up from the decay of Promethium adding negative reactivity. The overall effect is positive as shown in Table 1.

TABLE 1  
In core reactivity changes

Source of in-core reactivity changes.	$\Delta k$ depth	time interval
(a) Power changes, hut shutdown to hot full power.	medium (+ve, -ve)	seconds, minutes
(b) Fuel and Coolant temperature changes.	medium (+ve, -ve)	seconds, minutes
(c) Moderator temperature change.	small (+ve, -ve)	minutes
(d) Fresh fuel burn up.	large (-ve)	6 - 7 months
(e) Equilibrium Xe load build up.	large (-ve)	40 hours
(f) Xe transient build up.	large (-ve)	<12 hours
(g) Flux Oscillations.	medium (+ve, -ve)	15 - 30 hours
(h) Equilibrium fuel burn up.	small (-ve)	days (continuous)
(i) Plutonium and Samarium build up.	medium (+ve)	300 hours

**TABLE 2: COMPARISON OF STATION REACTIVITY LOADS**

REACTIVITY WORTH CHANGE		NPD	DOUGLAS POINT	PICKERING A & B	BRUCE A & B
(a) Power Coefficient hot shutdown - hot full power	fresh fuel	-3.3 mk	-6 mk	-7 mk	-9 mk
	equilibrium fuel	-1.2 mk	-5 mk	-3 mk	-3.5 mk
(b) Fuel and Coolant temperature 25°C to 275°C	fresh fuel	-3 mk	-6 mk	-8 mk	-9 mk
	equilibrium fuel	-1 mk	-4.5 mk	-2.5 mk	-3 mk
(c) Moderator Temperature Coefficient	fresh fuel	-0.08 mk/ C	-0.06 mk/ C	-0.06 mk/ C	-0.07 mk/ C
	equilibrium fuel	+0.01 mk/ C	+0.03 mk/ C	+0.08 mk/ C	+0.09 mk/ C
(d) Fresh Fuel Burn Up		-9 mk	-20 mk	-26 mk	-22 mk
(e) Xe Equilibrium Load		-24 mk	-28 mk	-28 mk	-28 mk
(f) Xe Peak Load Xe Override Capability* Xe Override Time		-46 mk	-107 mk	-98 mk	-105 mk
		+2.4 mk	+10 mk	+18 mk	+15 mk
		35 min	30 min	45 min	40 min
(g) Zone Control Reactivity Worth		NONE	3 mk	5.4 mk	6 mk
(h) Reactivity Loss (Equilibrium Fuel)  Reactivity Gain/Refuelled Central Channel		-0.15 mk/day	-0.3 mk/day	-0.3 mk/day	-0.5 mk/day
		+0.1 mk	+0.2 mk	+0.2 mk	+0.5 mk
(i) Plutonium and Samarium Build Up		+2.5 mk	+6 mk	+6 mk	+6 mk

\* New elements only, will decrease by ~30% at end of life burn up.

227.00-13

As you can see the range of reactivity depths and insertion rates make it impractical to try to design a single control mechanism.

### Methods of Reactivity Control

Before we can discuss actual control mechanisms we must look at the theoretical methods of reactivity control. Recalling that:

$$k = \epsilon p \eta f \Lambda_f \Lambda_t$$

we will examine which of the six factors we can use to change/control reactivity (remember  $\Delta k = \frac{k - 1}{k}$ )

First neither the fast fission factor ( $\epsilon$ ) nor the resonance escape probability ( $p$ ) are easily varied. They depend on the amount of U-238 present and the lattice spacing in the reactor. Therefore, we make no attempt to control reactivity by controlling  $\epsilon$  or  $p$ .

Next is the reproduction factor ( $\eta$ ).

Recall that:

$$\eta = \nu \frac{\Sigma_f^{\text{fuel}}}{\Sigma_a^{\text{fuel}}}$$

If we increase the amount of fissile material present ( $\Sigma_f^{\text{fuel}}$ ) we will increase  $\eta$ . That is, more neutrons will be produced per neutron absorbed by the fuel.

Thermal utilization ( $f$ ) is the fraction of neutrons absorbed by the fuel to those absorbed in the whole core:

$$f = \frac{\Sigma_a^{\text{fuel}}}{\Sigma_a^{\text{fuel}} + \Sigma_a^{\text{non-fuel}}}$$

If we increase or decrease the amount of non-fuel absorption, we vary  $f$ , hence reactivity. Variation of neutron absorption is by far the most common method of control.

Finally we have the fast and thermal non-leakage probabilities ( $\Lambda_f$  &  $\Lambda_t$ ). If we vary the leakage of neutrons from the reactor we will vary reactivity.



### Reactivity Mechanisms

In order to discuss the reactivity mechanisms presently in use we shall divide them into five groups based on their basic function in the reactor. The five functional groups are:

- 1) Automatic Reactor Regulation - (includes bulk power and zone control)
- 2) Xenon Override.
- 3) Long Term Reactivity Control - (includes fresh fuel burn up, the build up of equilibrium xenon and the build up of plutonium and samarium after shutdown).
- 4) Equilibrium Fuel Burn up.
- 5) Shutdown Systems

For each of these categories we will discuss the methods used and the significant advantages and disadvantages of those methods (See 433.50-1 for a discussion of the mechanics of the systems). Table 3 indicates which systems are used at each station and the reactivity depth of each system.

### Automatic Reactor Regulation

- a) Moderator Level Control.  
Small changes in moderator level change the thickness of the reflector on top of the reactor thus varying leakage ( $\Lambda_f$  &  $\Lambda_t$ ).
- Advantages:
  - 1) Easily incorporated into a system using moderator dump for protection.
- Disadvantages:
  - 1) Zone control is not possible.
  - 2) Lowering the moderator level distorts the overall flux distribution.
- b) Control Absorbers.  
Solid rods of a mildly absorbing material (typically stainless steel) which can be operated vertically in the core. Because they are parasitic absorbers the control absorbers change the thermal utilization (f).

Advantages:

- 1) Provide additional reactivity at minimal cost.

Disadvantages:

- 1) In core guide tubes represent, permanent, reactivity loss (fuel burn up loss).

c) Liquid Zone Control (LZC)

Zone Control Compartments inside reactor which contain a variable amount of light water (a mild neutron absorber). Varying the amount of light water in the LZC, varies parasitic absorption hence thermal utilization (f).

Advantages:

- 1) Individual zone levels can be independently varried for zone control.
- 2) Operating equipment is mainly outside contain-ment, therefore, accessible during reactor operation.
- 3) Cooling easily accomplished.
- 4) Only slight distortion of the overall flux pattern.

Disadvantages:

- 1) Requires special design to insure that the zones fail safe (ie, fill).
- 2) In core structure represents a reactivity (or fuel burn up) loss.

Xenon Override

a) Booster Rods.

Solid rods of highly enriched (~90%) U-235. In-  
sertion of booster rods increases the amount of  
fissile material in the reactor hence the repro-  
duction factor ( $\eta$ ). It also increases f.

Advantages:

- 1) Can provide large override capability.

## Disadvantages:

- 1) Enriched Uranium is a very expensive, non-Canadian product.
- 2) Require highly reliable source of cooling (loss of cooling to an inserted booster at high power could cause the rod to melt down in about 5 seconds).
- 3) Because of cooling requirements additional trips are required thus complicating the reactor protection systems.
- 4) Limited lifetime as the reactivity worth decreases with each use.
- 5) A criticality hazard exists in the storage of both new and irradiated booster rods.
- 6) Because of all of the above reasons, the AECB requires special licenses, which, at this writing ( June 1979) BNGS A does not have.

b) Adjuster Rods

Solid rods of a neutron absorbing material (Cobalt or Stainless Steel). Normally fully inserted in the reactor thus increasing parasitic absorption (decreasing  $f$ ). Positive reactivity is provided by withdrawing the adjuster rods.

## Advantages:

- 1) Provide flux flattening which must be provided by some other method if booster rods are used for xenon override.
- 2) No significant decrease in reactivity worth over normal lifetime.

## Disadvantages:

- 1) Presence of adjusters results in a fuel burnup penalty of ~8%. (The adjusters reduce  $f$ , therefore, we must increase one of the other factors. Thus  $\eta$  is increased by not allowing the fuel to burn out as much.

### Long Term Reactivity Control

The method of long term reactivity control presently in use is the addition of soluble poison to the moderator. While solid rods could be used for this purpose, soluble poison systems are cheaper and cause no flux distortions. However, the addition of poison to the moderator does reduce the flux reaching the ion chambers sufficiently to require that the power reading from out of core ion chambers be corrected for the presence of the poison. Boron in the form of boric acid  $B_3O_3$  or gadolinium in the form of gadolinium nitrate  $Gd(NO_3)_3 \cdot 6H_2O$  are the poisons presently in use. Gadolinium has the advantage over boron for Xe load simulation because the neutron burn up rate of the neutron absorbing gadolinium isotopes ( $Gd155$  and  $Gd157$ ) and the Xe build up are sufficiently complementary that little adjustment of the gadolinium concentration by IX control is necessary during start up. The IX columns are, however, used to remove the reactivity build up of low cross section gadolinium absorption products to limit their accumulation in the moderator.

Using boron to simulate Xe load needs a closely monitored operation of the cleanup circuit to obtain the rapid reduction of boron required (3.5 ppm = 28 mk), boron removal being essentially only dependent on the IX removal rate rather than neutron burn up rate. Much more IX column capacity is also needed for B removal than for the Gd system. Gadolinium is not used at Pickering A as there is some concern that it may lead to high deuterium gas levels in the cover gas system due to increased radiolysis of the moderator.

### Equilibrium Fuel Burn Up

On power refueling is used in all of Ontario Hydro's reactors. This essentially keeps the amount of fissile material constant by replacing irradiated fuel with fresh fuel more or less continually. This system of refueling has several distinct advantages:

- 1) No downtime for refueling
- 2) Better average fuel burnup
- 3) Better flux shaping.
- 4) Failed fuel can be removed easily without a shutdown.

There are of course some disadvantages mainly the high capital cost of the fueling machines and the maintenance which is required for them.

If the fueling machines are unavailable for some reason, there is a limited time the reactor can continue to operate.

A Bruce 'A' reactor normally consumes 0.5 mk/day. (That is the reactivity worth of the fuel diminishes at that rate). If the LZC were at 50% at full power in an equilibrium fuel condition, about 3 mk of excess positive reactivity would be available. That gives approximately 6 days of operation before we must start inserting the boosters (actually undesirable for this purpose) or reduce the operating power (called derating) or shutdown the reactor.

On the other hand, if you overfuel the reactor you may have to derate the reactor due to the high flux in the area of the new fuel, (called regional overpower).

#### Shutdown Systems

Early Candu designs had a single shutdown system. As the design of the reactor became more sophisticated, the requirement for extremely high reliability dictated that two independent shutdown system be provided. There are presently three types of shutdown systems in use.

##### 1) Moderator Dump

As the moderator level decreases, the physical size of the active portion of the core decreases. As the core gets smaller, leakage increases ( $\Lambda_f$  and  $\Lambda_t$  go down).

##### Advantages:

- 1) Simple, fail safe with gravity system.
- 2) Absolute shutdown, with the moderator dumped the core cannot be made critical.

##### Disadvantages:

- 1) Slow for a large reactor. The initial reactivity insertion rate may not be adequate to protect the reactor from certain types of accidents. Figure 1 shows reactivity vs time for moderator dump at PNGSA. Note that in the first two seconds only -2mk of reactivity has been inserted.
- 2) Time required to pump the moderator back into the calandria is so long (~50 min. at PNGSA) in a larger reactor that a poison out is quite possible.

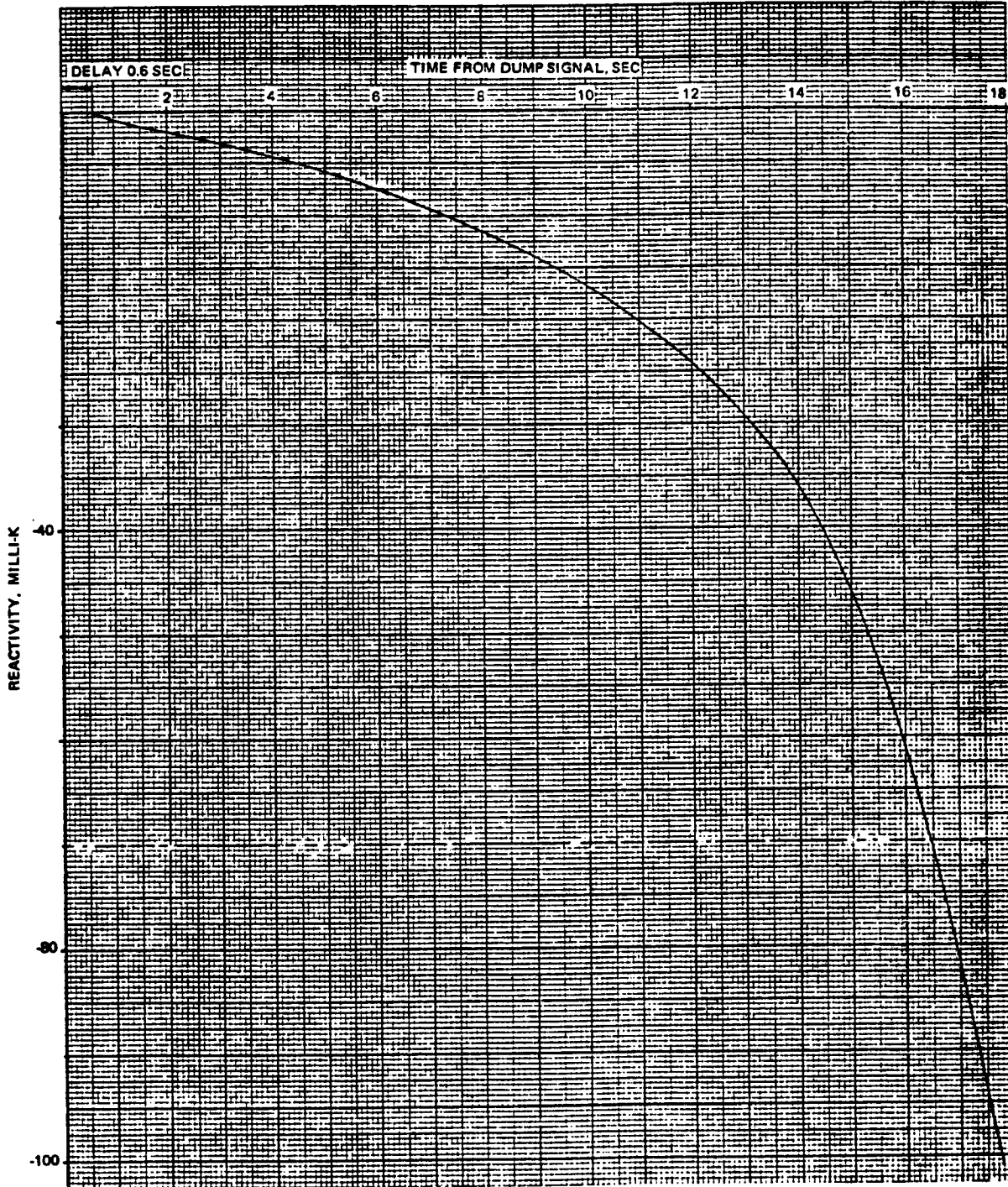

REACTIVITY VERSUS TIME FROM INITIAL MODERATOR DUMP SIGNAL  
(100 PERCENT MODERATOR LEVEL, EQUILIBRIUM FUEL CONDITIONS) 44.01100-46

FIGURE 1

## 2) Shutoff Rods

Hollow cylinders of neutron absorbing material (normally stainless steel sheathed cadmium) which can be gravity dropped into the reactor. Their presence greatly increases parasitic absorption thus reducing the thermal utilization (f).

### Advantages:

- 1) Rapid reactivity insertion as required for protection in certain worst case accidents. Figure 2 shows reactivity vs time for PNGSA shutoff rods. Note that in 2 seconds the rods have inserted -22 mk.
- 2) Rapid recovery from a trip is possible. (~3 minutes to withdraw the rods).

### Disadvantages:

- 1) Limited reactivity depth. As presently designed shutoff rods do not provide enough reactivity for a guaranteed long term shutdown.
- 2) Complex system (relative to dump) subject to mechanical failure. Safety analysis normally assumes that the two most reactive rods don't drop on a trip.

## 3) Poison Injection

Poison (Gadolinium) is injected into the moderator under high pressure. This causes a large reduction in the thermal utilization (f).

### Advantages:

- 1) Rapid insertion of reactivity. Figure 3 shows reactivity vs time for BNGSA poison injection system. Note that -33 mk is inserted in 1.5 seconds. Total worth is approximately -675 mk.

### Disadvantages:

- 1) Poison must be removed from the moderator by ion exchange which is costly and slow (~12 hours). If poison injection shuts down the reactor, a Xenon poison out will occur before the moderator poison can be removed.

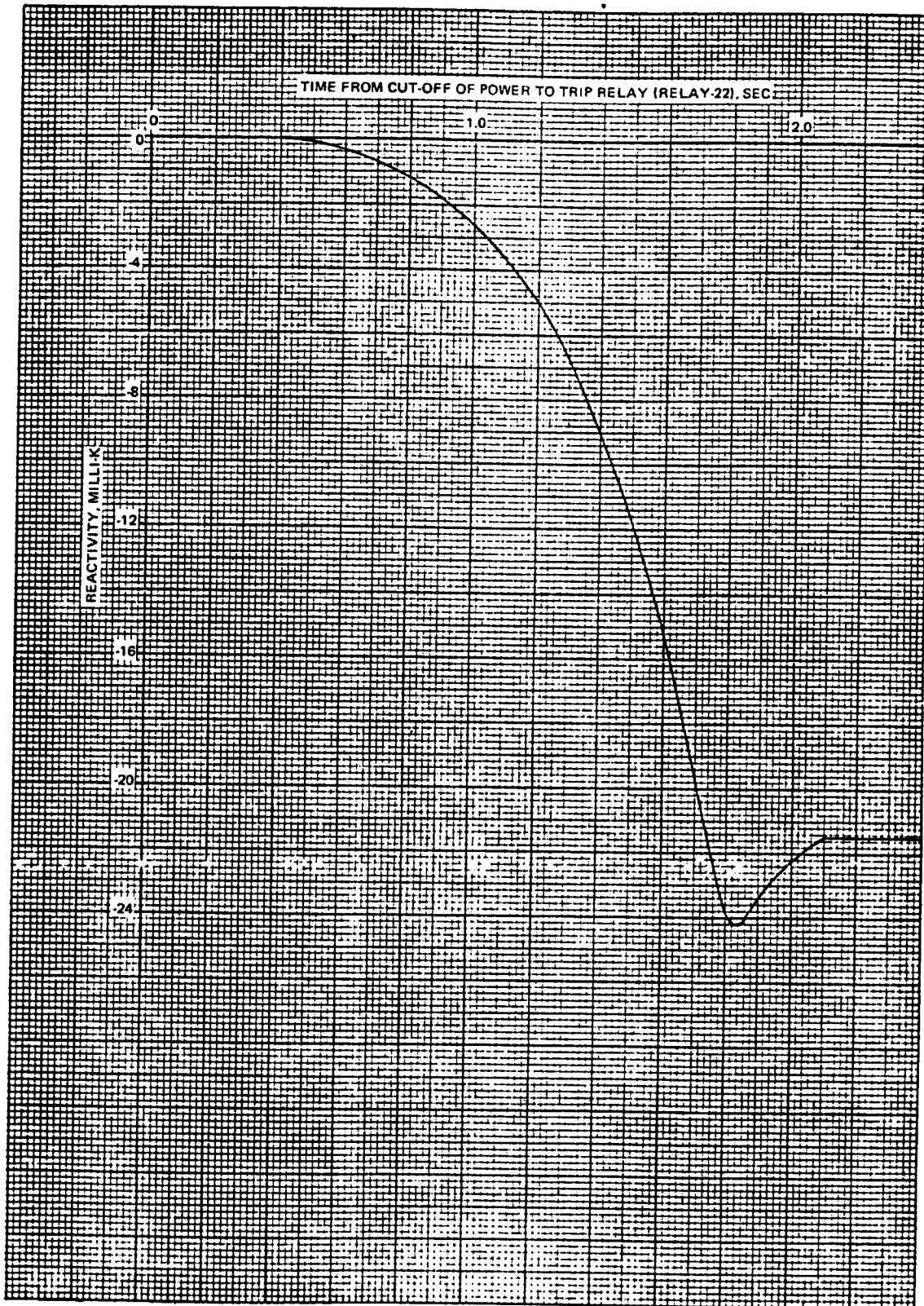

REACTIVITY VERSUS TIME FROM TRIP SIGNAL (RELAY-22) FOR SHUT-OFF ROD DROP AT FULL MODERATOR LEVEL, EQUILIBRIUM FUEL CONDITIONS

44-01100-

FIGURE 2



FIGURE 3

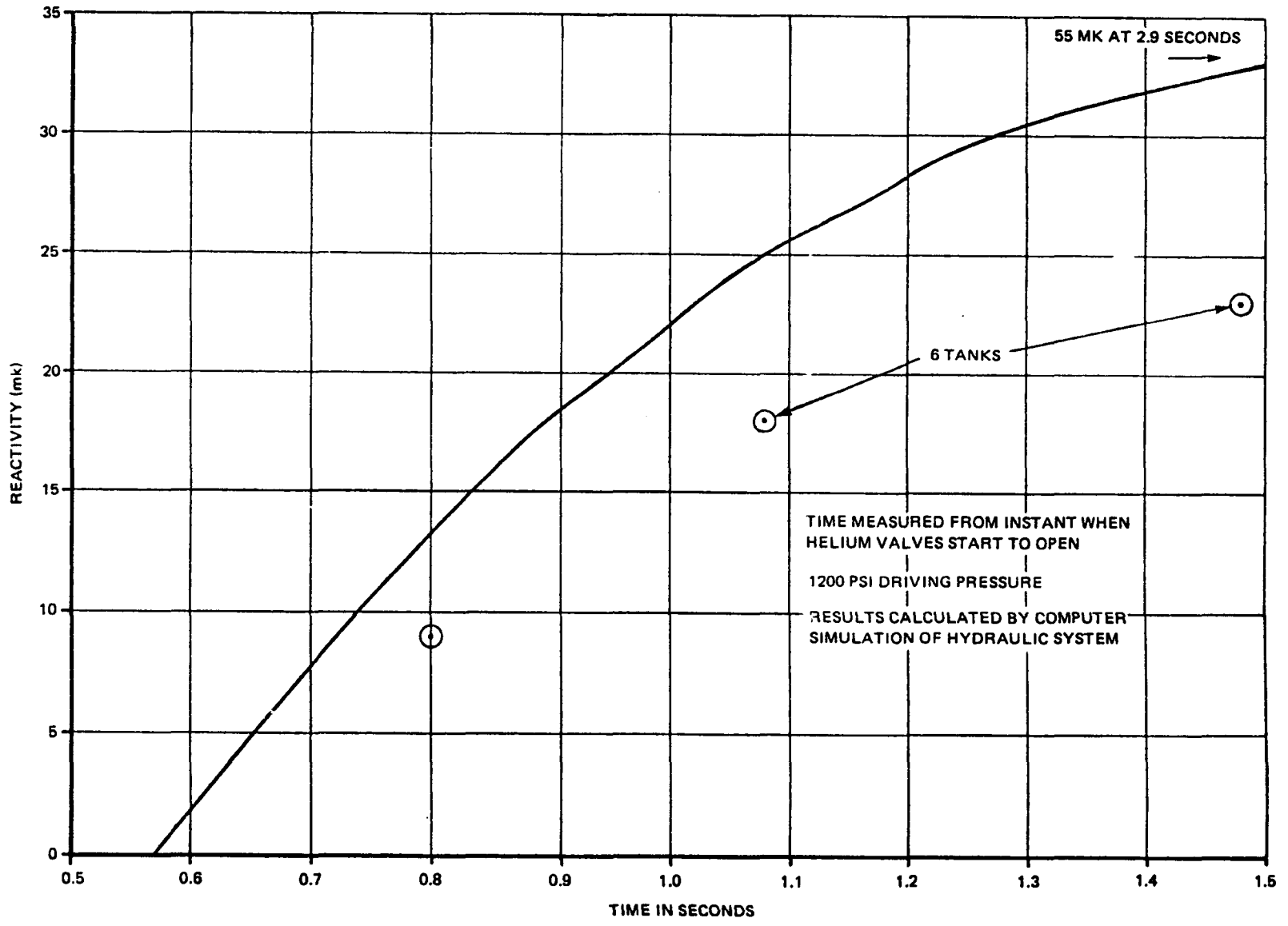

Reactivity Vs Time, For Poison Injection.

		NPD	Douglas Pt.	Pickering A	Bruce A	Pickering B	Bruce B
Automatic Reactor Regulation(1)	Primary	Moderator Level Control	4 Control Absorbers (3mk)	14 Liquid Control Zones (5.4mk)	14 Liquid Control Zones (6mk)	14 Liquid Control Zones (6mk)	14 Liquid Control Zones (6mk)
	Secondary	NONE	Moderator Level Control	Moderator Level Control	4 Control Absorbers (7mk)	4 Control Absorbers (10mk)	4 Control Absorbers (9.5mk)
Xenon Override		1 Booster Rod (2.4mk)	8 Booster Rods (10mk)	18 Adjuster Rods (18mk)	16 Booster Rods (15mk)	21 Adjuster Rods (18mk)	24 Adjuster Rods (18mk)
Long Term Reactivity Control		Moderator Level Control	Moderator Poison Addition (Variable reactivity depending on poison Concentration)				
Equilibrium Fuel Burn up		All Stations use on power refueling					
Shutdown Systems	SDS 1	Moderator Dump	Moderator Dump	11 Shutoff Rods (24mk)	30 Shutoff Rods (40mk)	28 Shutoff Rods (48mk)	32 Shutoff Rods (69mk)
	SDS 2	NONE	NONE	Moderator Dump (2)	Poison Injection (55mk in 2.9s)	Poison Injection (N/A)	Poison Injection (55mk in 2.9s)

- NOTES: (1) The primary system is normally used for reactor regulation. If the primary system is unavailable or has insufficient reactivity depth, the secondary system will act automatically.
- (2) Operation of the dump system at Pickering A is not entirely independent of the shutoff rods.

TABLE 3  
Reactivity Control Systems

ASSIGNMENT

1. A Bruce reactor trips inserting - 40mk due to the shutoff rods. Using the information in Table 2 and assuming an equilibrium fuel condition, would you expect the reactor to remain shutdown (subcritical) if the heat transport system was kept at normal operating temperature? If the heat transport system was cooled down? Justify your answers.
2. Both methods of Xenon Override require derating when used. Explain why.
3. Simple chemical analysis for boron or gadolinium is not considered sufficient to determine the reactivity worth of moderator poison, explain why.

J.E. Crist  
A. Broughton

## Nuclear Theory - Course 227

## THE APPROACH TO CRITICAL

---

The initial approach to criticality is a procedure undertaken with a great deal of respect because the reactor is in a potentially dangerous condition. The reasons for this are:

1. Available reactivity is near its maximum value since there has been no fuel burnup and there are no fission products present. This excess positive reactivity is compensated for by moderator poison; however, the poisons are removable, hence the possibility of a large positive reactivity insertion exists.
2. Normal nuclear instruments (ion chambers and/or flux detectors) will be "off scale" at their low end ( $\sim 10^{-5}$  of full power); therefore, the regulating system will not automatically control the reactor.
3. Although startup instruments (He-3 or BF<sub>3</sub> detectors) will be wired into the shutdown systems, their response becomes increasingly longer as the flux levels decrease.
4. The critical value of the control variable is not precisely known. For example if the approach to critical is being made by raising moderator level, the critical level is only a design estimate. (These are generally quite accurate.)

During the approach to criticality the reactor will by definition be subcritical. Therefore, you should review the behaviour of neutron power in a subcritical reactor. (lesson 227.00-9).

The First Approach to Critical

The most common method in the past has been to raise moderator level until enough fuel was covered to sustain a chain reaction. More precisely,  $k_{\infty}$  was fixed and the leakage was gradually reduced until  $k$  was exactly 1. This procedure was used at NPD, Douglas Point and Pickering Units 1 and 2.

Alternatively, with a high enough poison concentration in the moderator to ensure that criticality cannot be possible. Start at a certain moderator level (nominally near full calandria). (This is known as guaranteed shutdown state.

The poison is then gradually removed until criticality is reached. In this case, the leakage is nearly constant, and  $k$  is increased by raising the value of  $f$ , the thermal utilization, until  $k$  becomes equal to 1. This was the procedure used at PNGS 'A' Unit 3, and BNGS 'A', which of course doesn't have moderator level control at all. It will be used on all future reactors.

### Pickering Unit 1

The conditions prior to the startup were as follows:

1. A boron concentration of 7.25 ppm was chosen for the moderator system to achieve a first critical level just above 4 m. This figure was obtained from design calculations.
2. All adjuster rods were fully inserted, and all light water zone compartments were full.
3. The heat transport system was cold (46° C) and pressurized with the normal number of heat transport system pumps (12) running.
4. Three fission counters (designated NT9, NT8 and NT7), mounted in an aluminum tube, and one He-3 counter were located in channel U-11 which was otherwise empty (ie, no fuel or heat transport fluid).
5. Three more He-3 counters were mounted outside the core (in the ion chamber housing) to test a proposal to startup later Pickering units using out-of-core instruments alone.
6. The count rates from the in-core neutron counters were determined by feeding their output pulses to scalers, which counted all pulses arriving in a preset time (of the order of 5 minutes at low count rates).
7. The protective system trips were set on the output of rate-meters connected to the fission counters NT8 and NT9 and the He-3 counter in channel U-11. Trip levels were always maintained at about one decade above the prevailing count rate.

The approach to critical was monitored by devising an (approximately) linear plot which could readily be extrapolated to predict the critical moderator level. From lesson 227.00-9 recall that:

$$P_{\infty} = \frac{P_0}{1-k} = - \frac{P_0}{\Delta k}$$

Since the count rate on any detector is proportional to  $P_{\infty}$ , we can now write:

$$\frac{1}{\text{count rate}} \propto 1 - k \propto \Delta k$$

Since  $\Delta k$  is a direct function of moderator level (as level increase,  $k$  increases), we can plot the reciprocal count rate versus moderator level as shown in Fig. 1.

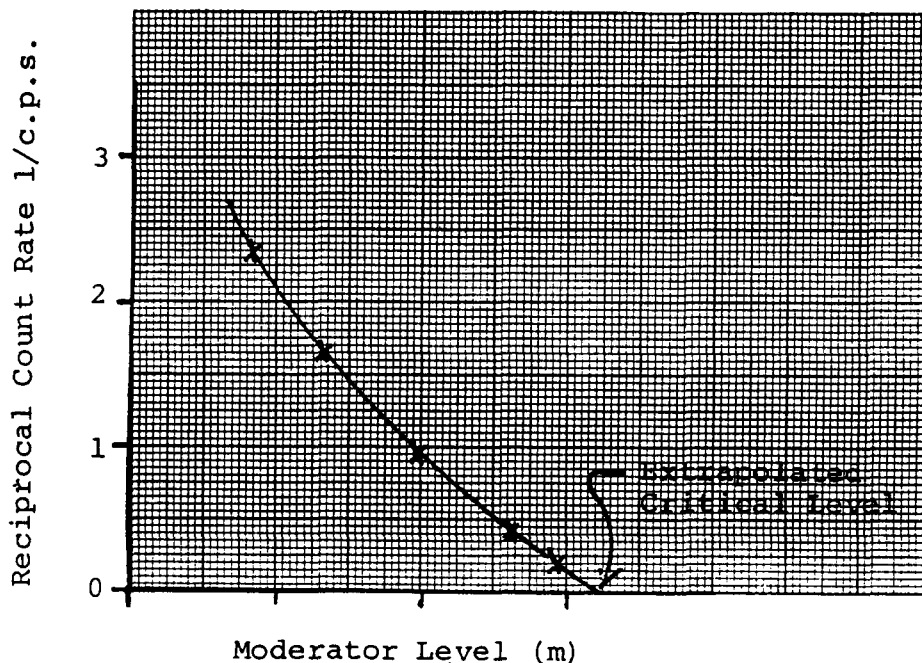

Figure 1

Approach-to-Critical Graph

The intercept of this curve with the moderator level axis should therefore give the critical level.

Pickering A, Unit 3 and all Bruce A units obtained initial criticality by removing poison (boron or a combination of boron and gadolinium) from the moderator. In these cases the moderator was at full tank throughout the startup. The multiplication constant ( $k$ ) is a direct linear function of poison concentration (1 ppm boron = 8.85 mk; 1 ppm gadolinium = 31.42 mk). Because of this, total poison load may be directly calculated and a plot of poison load versus inverse count rate is a straight line. Figure 2 is a plot of inverse count rates from the incore detectors for the Bruce A, Unit 1 initial criticality. Note that they all give straight lines which accurately predicted the poison concentration at criticality.

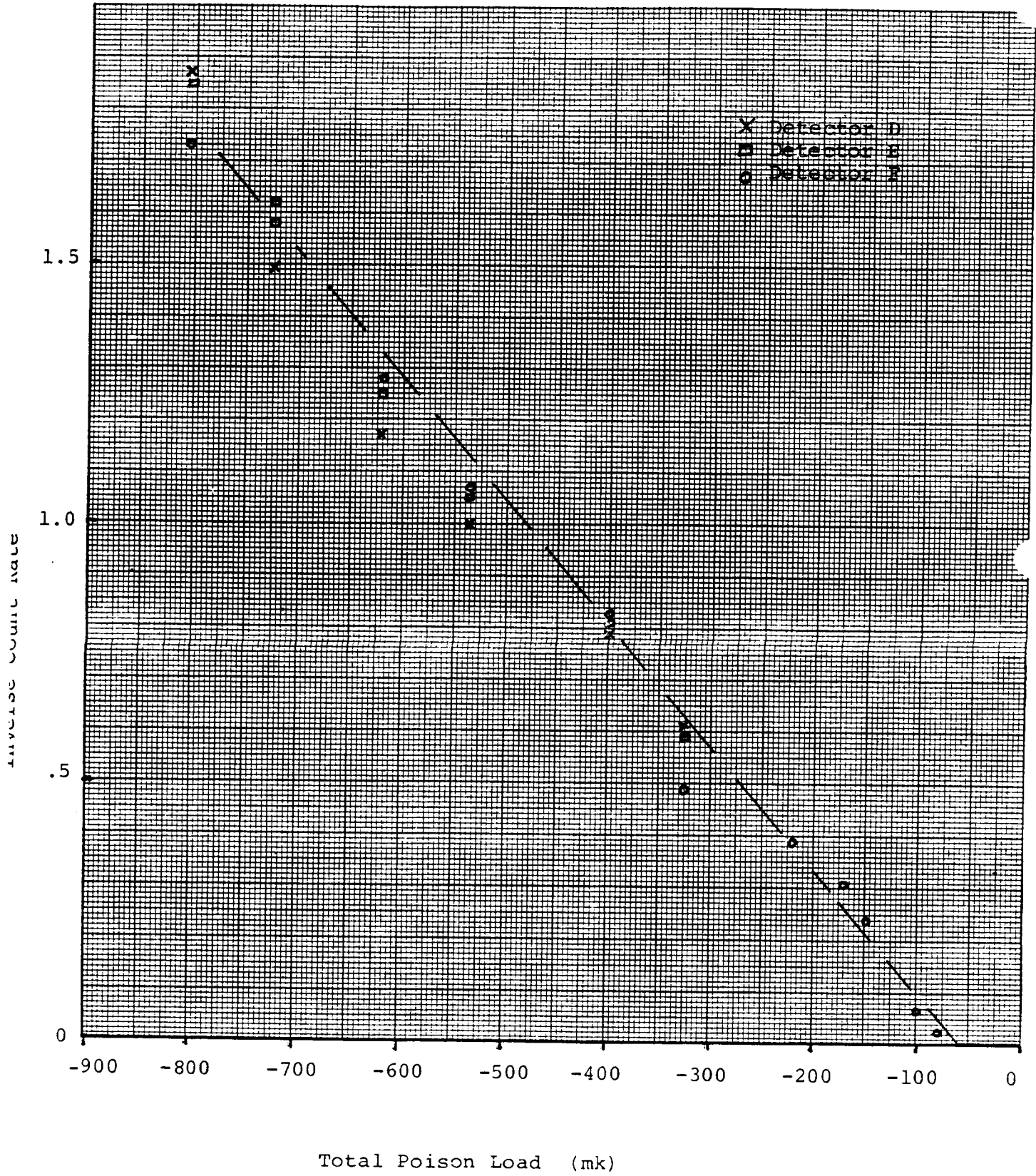

Figure 2

These types of approaches do not have to be repeated for every startup. Once sufficient fission products have been builtup to give a significant photoneutrons source, (ie, actual neutron power  $>10^{-5}\%$ ) the reactor may be started up using installed instrumentation and automatic regulation.

J.E. Crist  
A. Broughton