

FIGURE 3.7-2 XENON REACTIVITY TRANSIENTS AFTER STARTUP TO VARIOUS POWER LEVELS

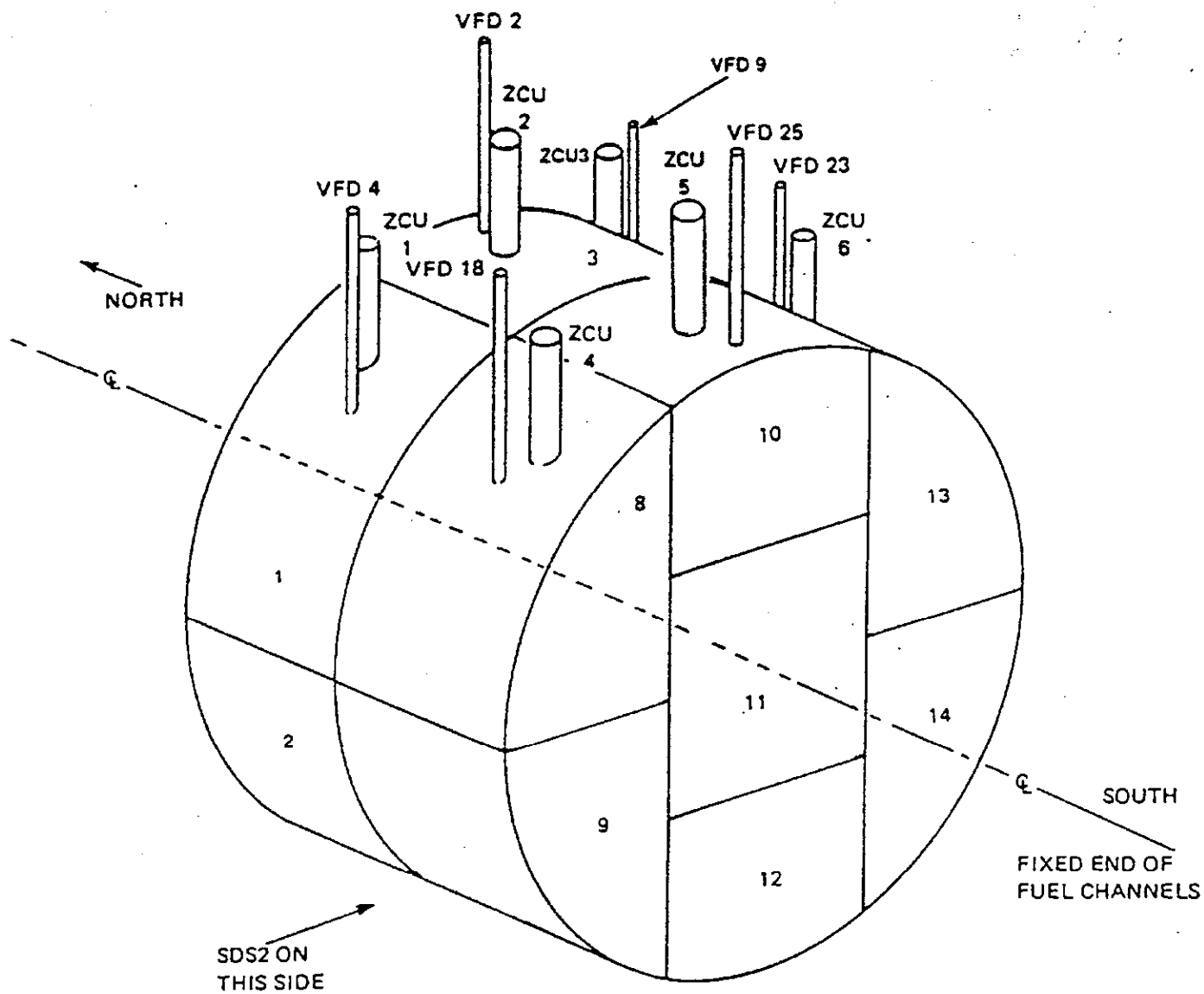

FIGURE 3.8-1 RELATION OF ZONE CONTROL UNITS (ZCU) TO THE FOURTEEN ZONES AND THE REACTOR ZONE CONTROL DETECTOR ASSEMBLIES VFD 2, 4, 9, 18, 23, 25

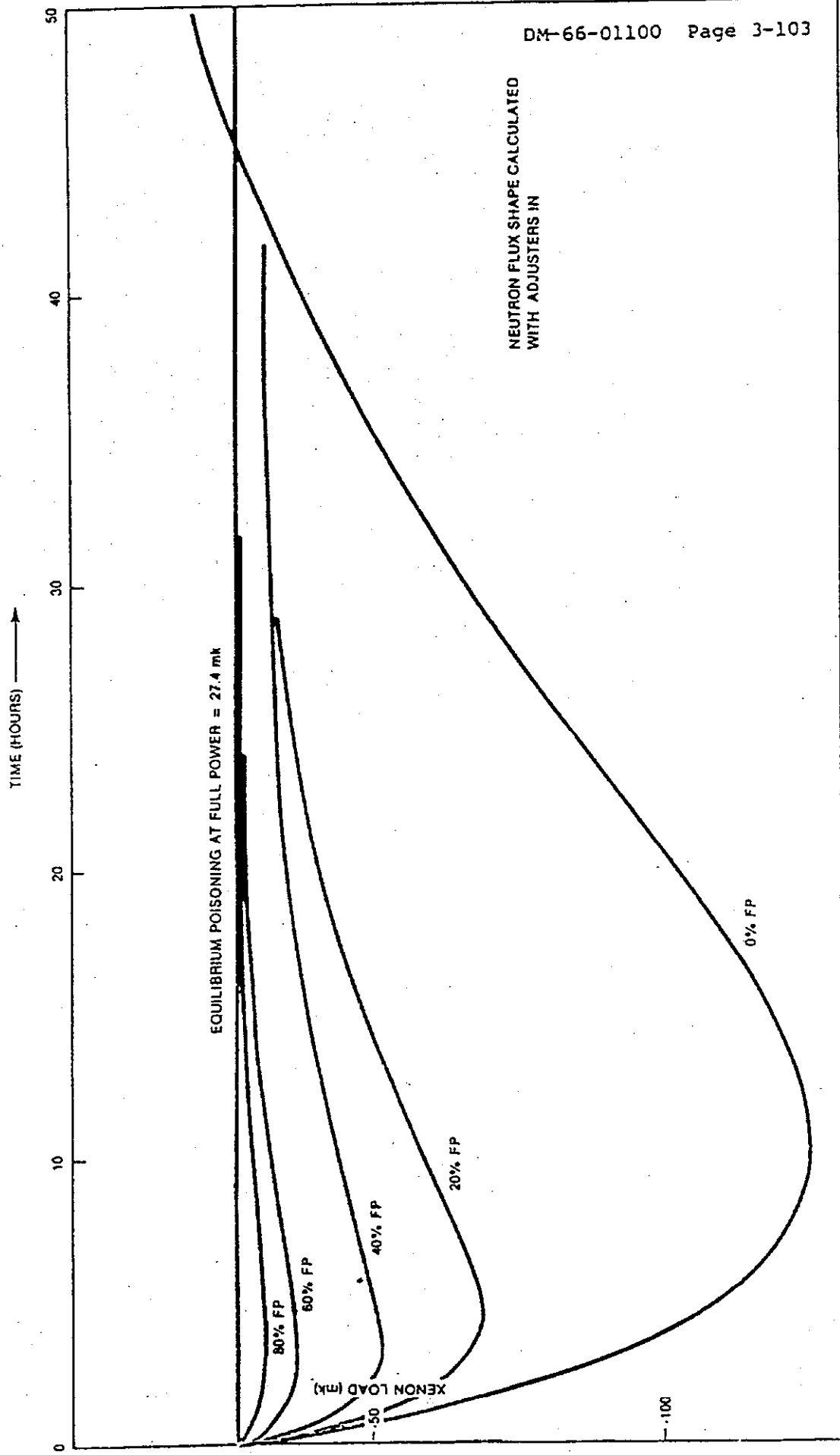

FIGURE 3.7-3 VARIATION OF XENON LOAD FOLLOWING STEP POWER REDUCTIONS TO 0,20,40,60 AND 80% OF FULL POWER FROM EQUILIBRIUM FULL POWER CONDITION

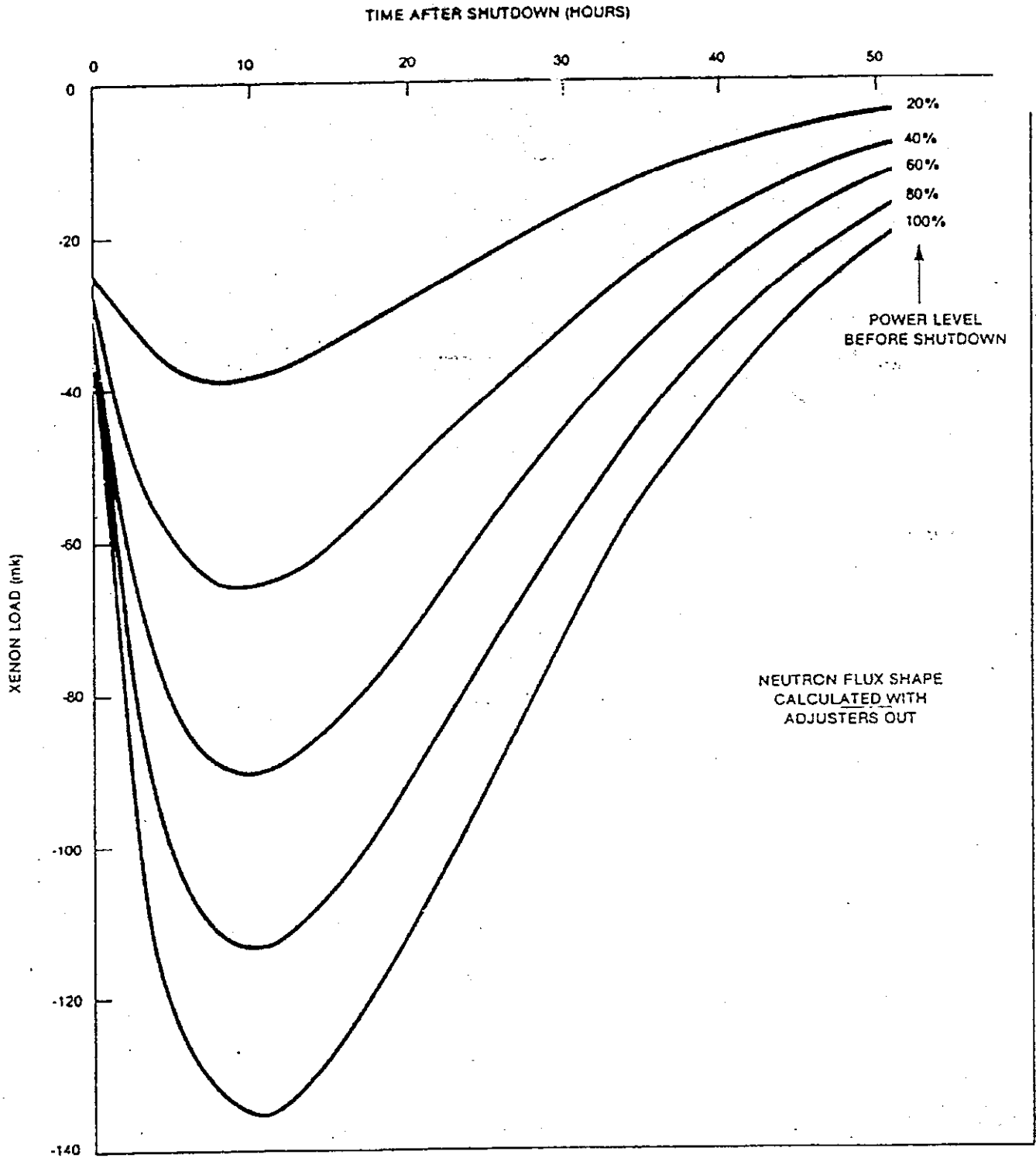

FIGURE 3.7-1 XENON TRANSIENTS AFTER SHUTDOWN FROM VARIOUS POWER LEVELS

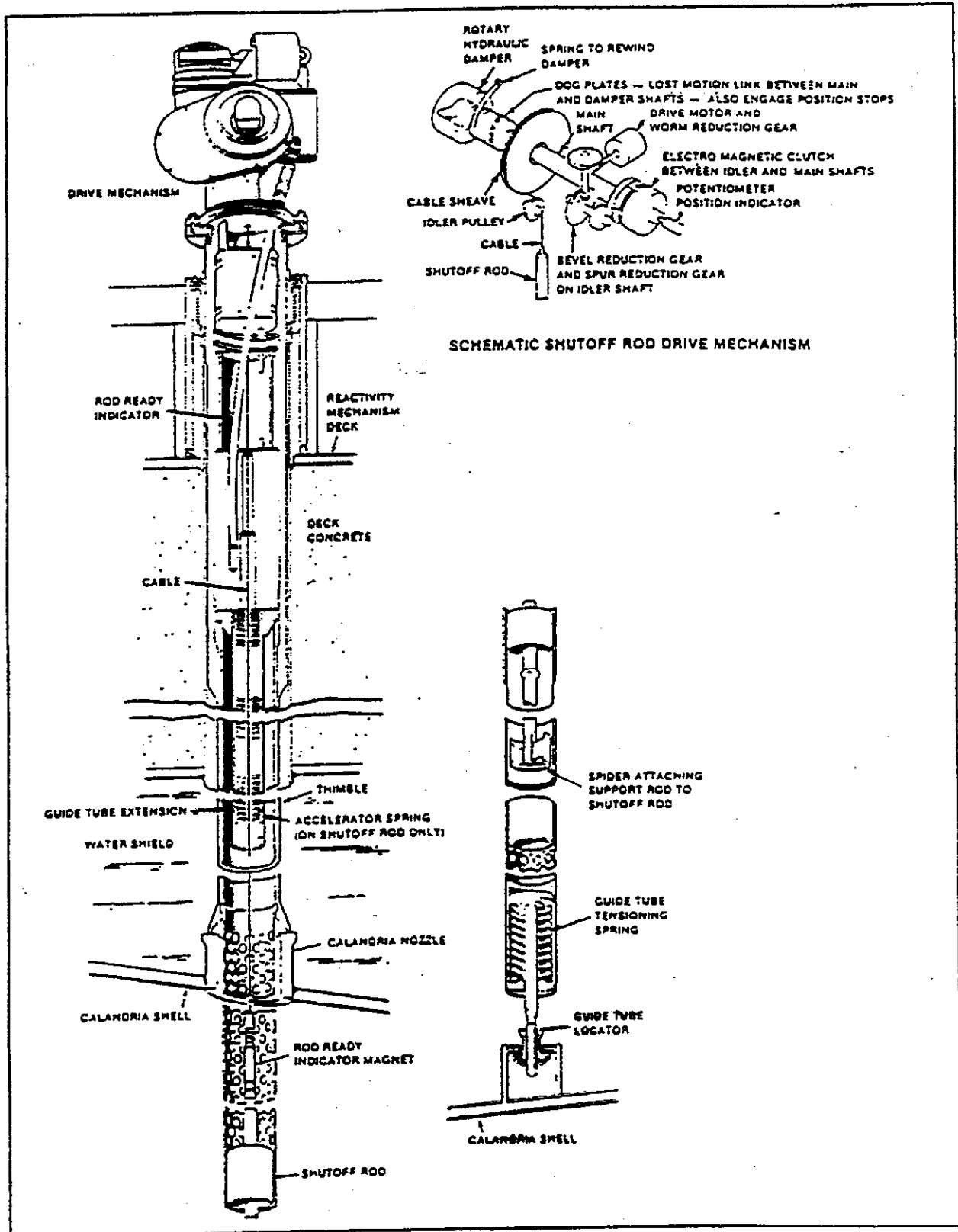

Figure 6.6 Barre d'arrêt.

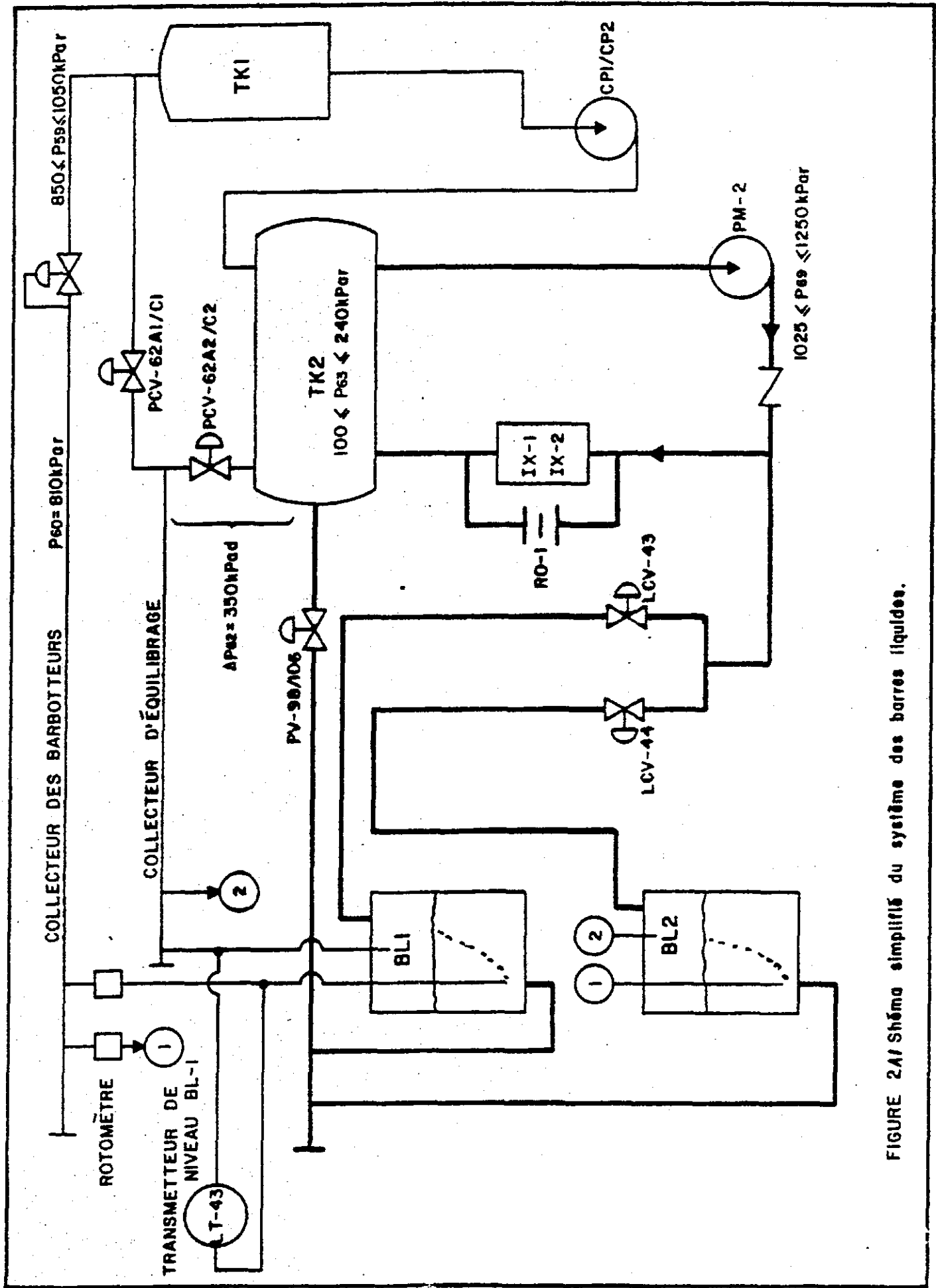

FIGURE 2.4/ Schéma simplifié du système des barres liquides.

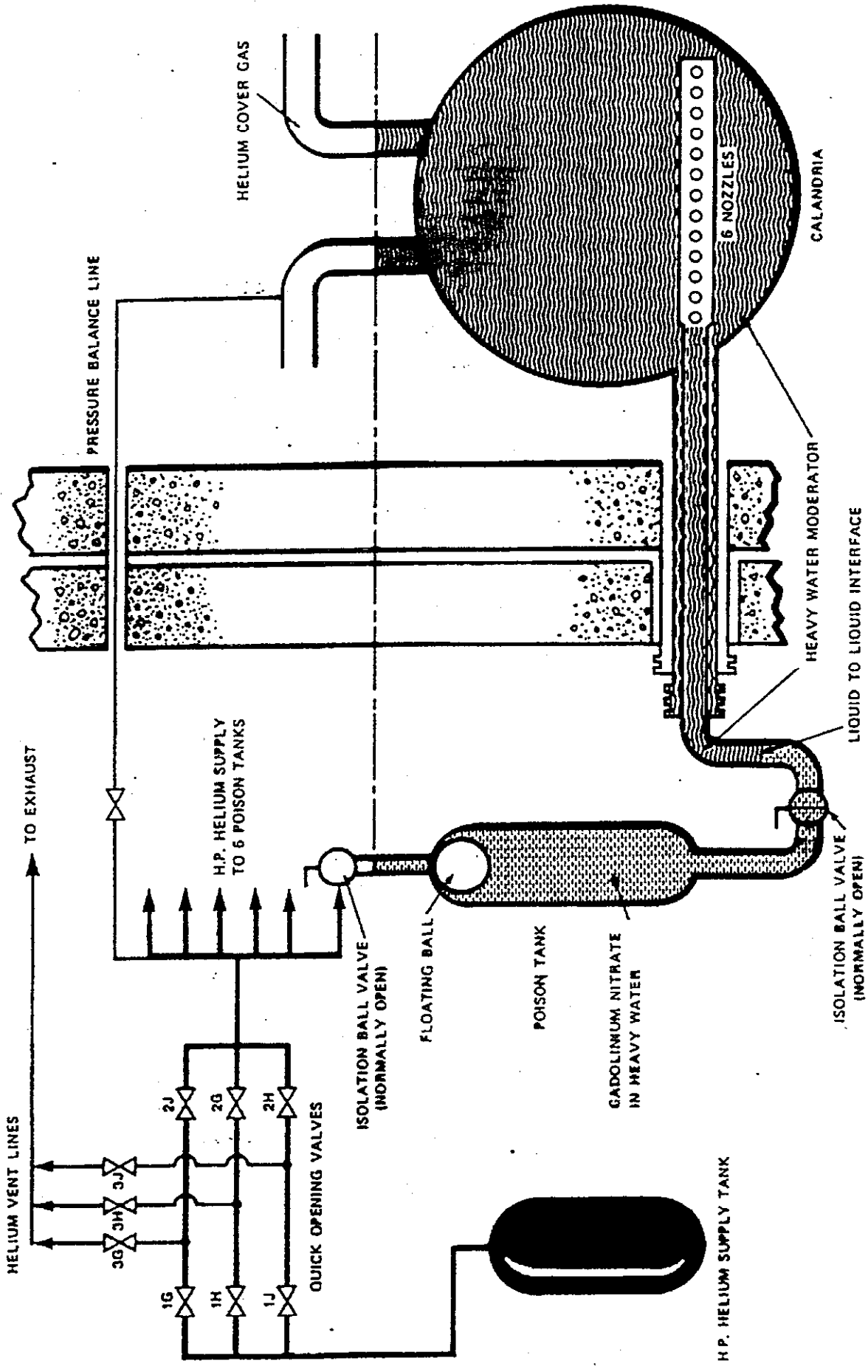
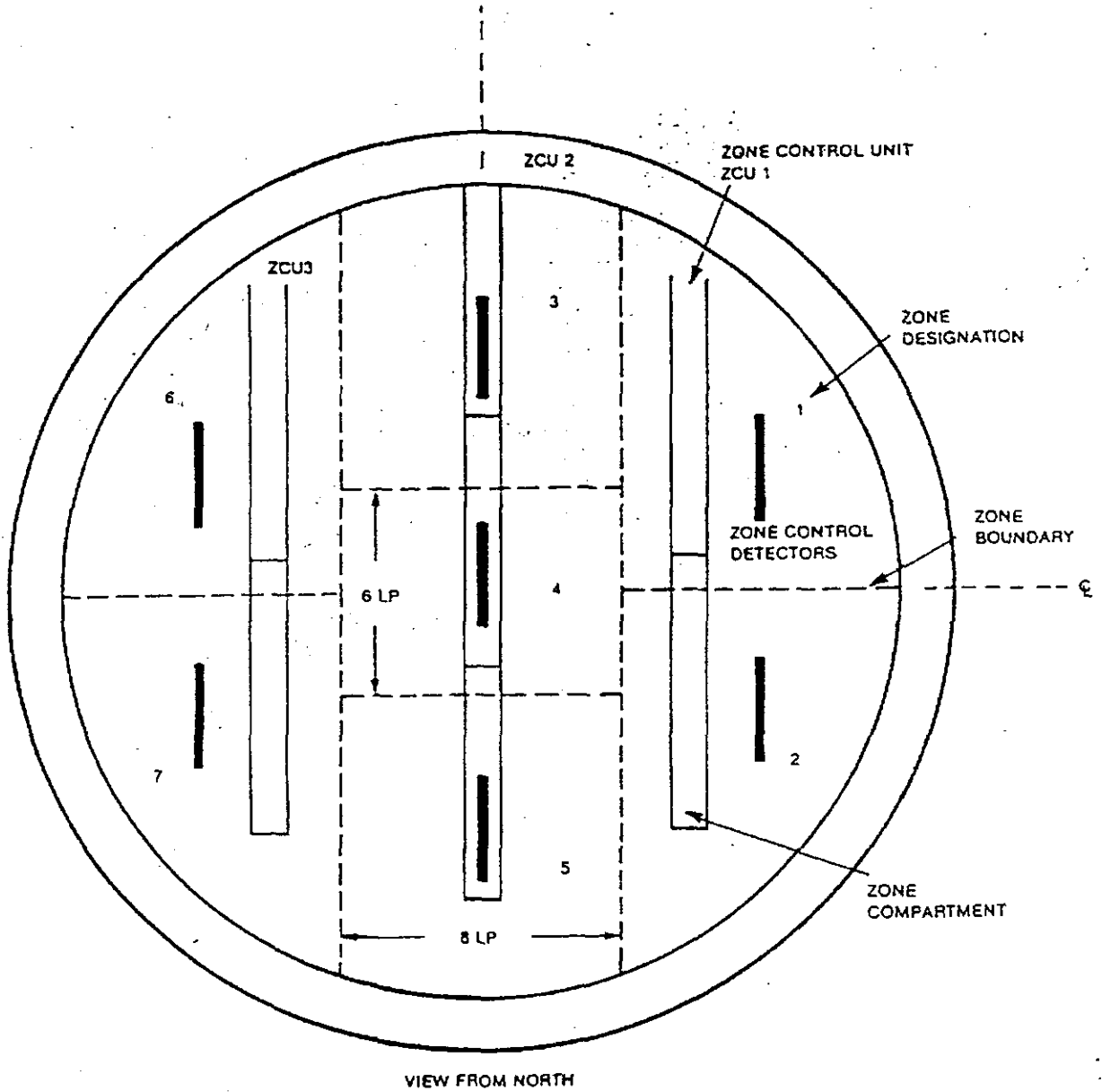

FIGURE 6.5 - 3 SHUTDOWN SYSTEM NO. 2



NOTES

1. LP = LATTICE PITCH
2. ALL ZONE CONTROL DETECTORS ARE 3 LATTICE PITCHES LONG
3. THE BANK OF CONTROLLERS ON THE SOUTH SIDE IS SYMMETRIC TO THIS.

FIGURE 3.8-2 POSITION OF ZONE CONTROL DETECTORS WITH RESPECT TO ZONE COMPARTMENTS

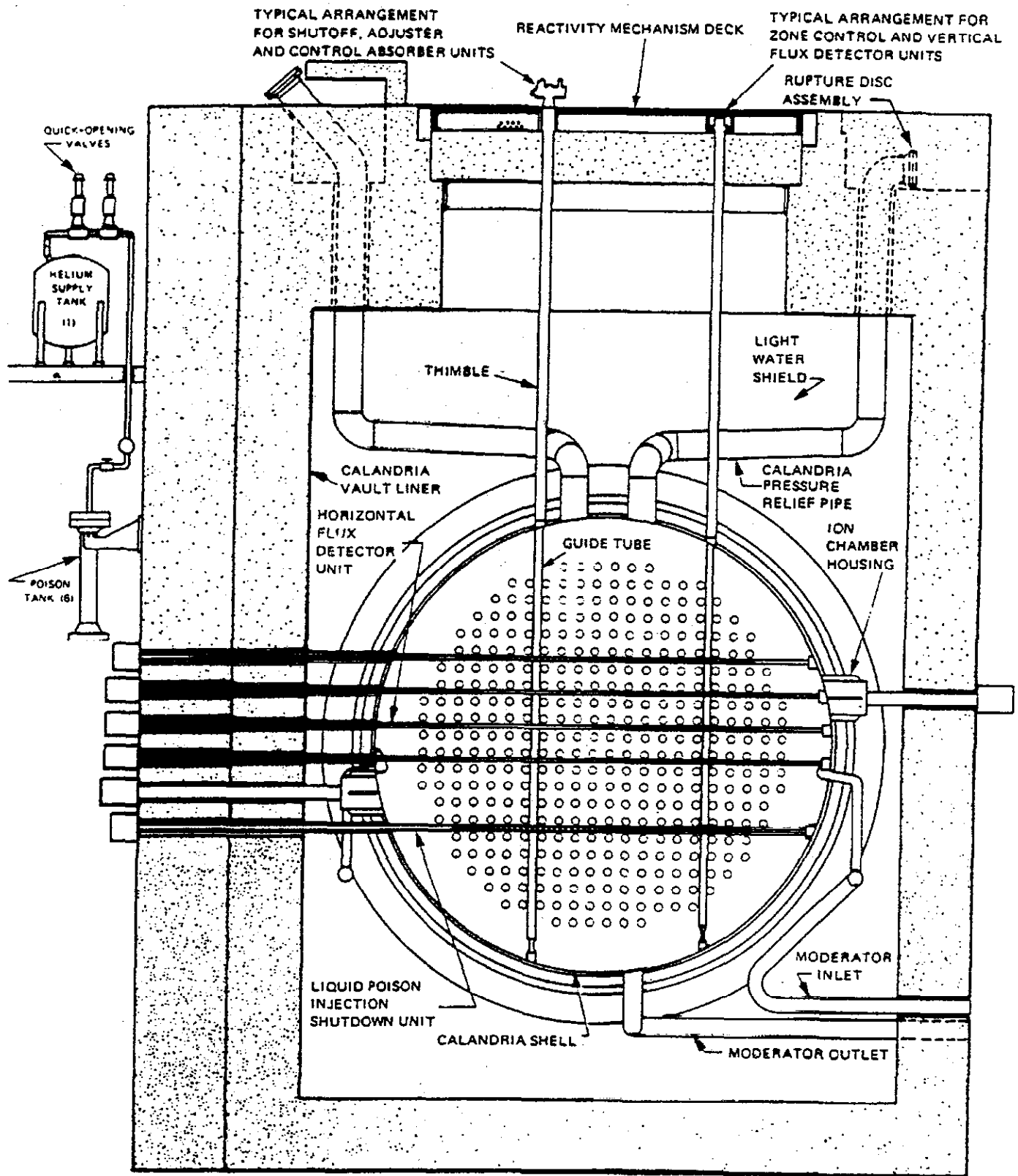
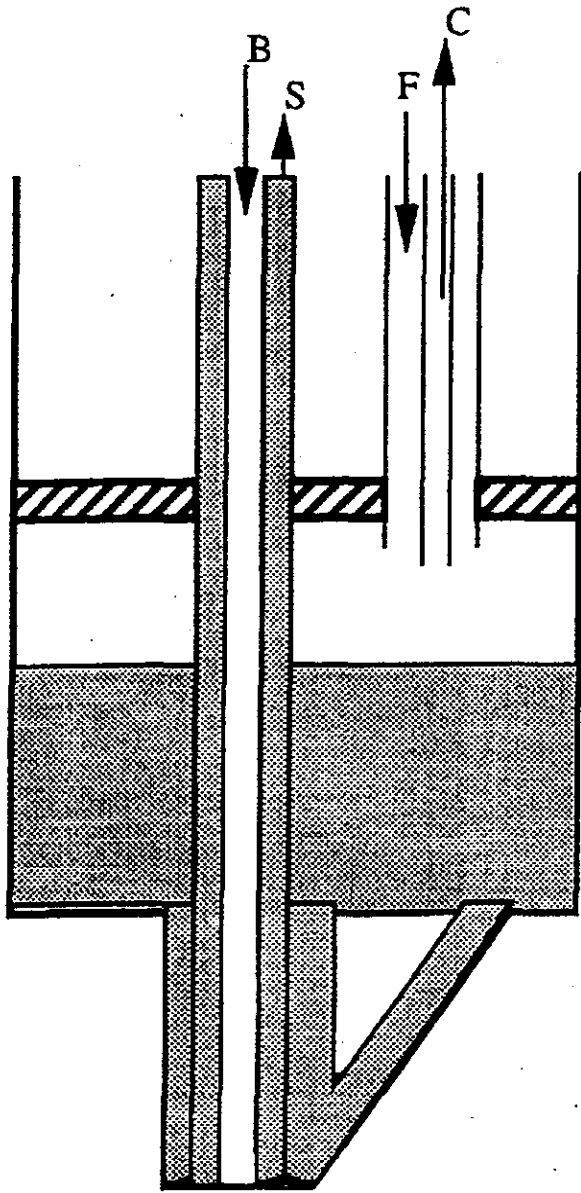

FIGURE 4.1.1-2 REACTOR LAYOUT - ELEVATION



B: Barbotteur d'Hélium

S : Sortie d'eau

F : Entrée d'eau

C : Equilibrage d'Hélium

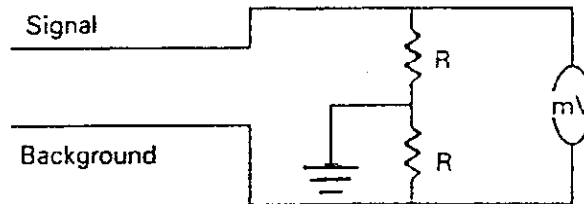
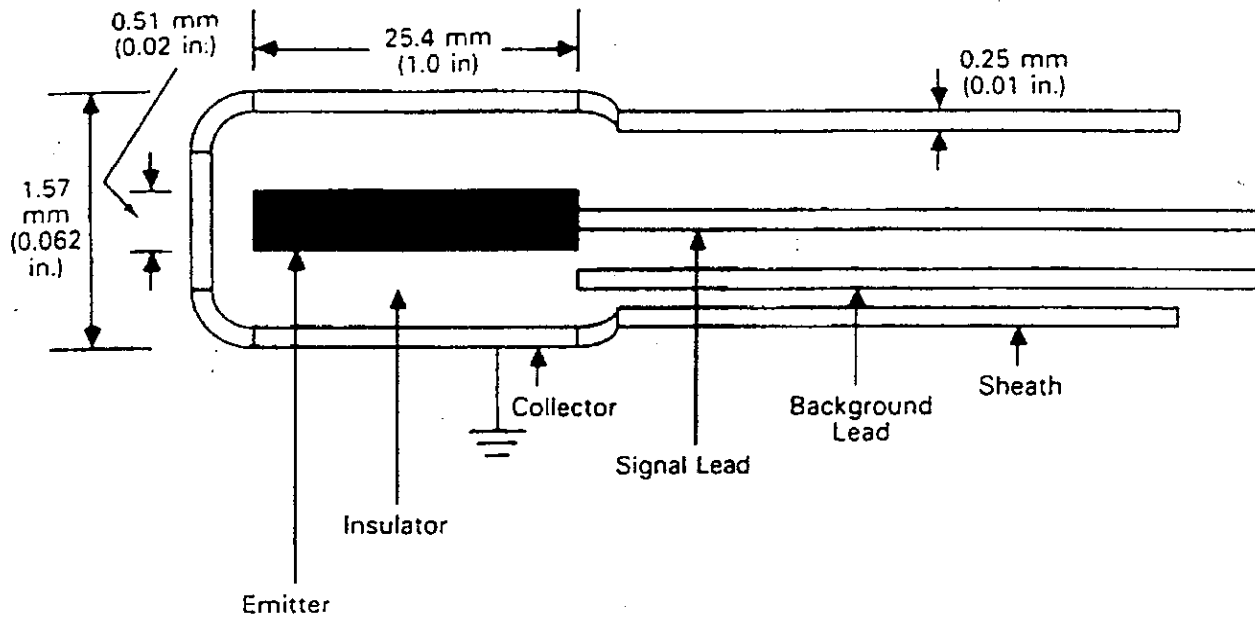

Fig. 1. Schematic of SPND with automatic background subtraction.

methods and is adaptable to other SPND types and sizes. In the analog method, the components of the electronic circuits are specified, and actual values and results obtained under realistic reactor conditions are shown. Unlike other approaches, the background compensation is dynamic and automatic.⁶ The problem with small currents, a result of small emitters, is handled in a manner that minimizes external noise interference. In the digital method, all constants are determined from basic physical parameters independent of the detector type, size, or environment.

II. THEORY OF THE RSPND DYNAMIC RESPONSE

The RSPND used in this work and shown in Fig. 1 is made up of three primary parts: the emitter, the insulator, and the collector. Neutrons that pass through the collector and the insulator can be absorbed by the rhodium emitter and lead to activation products that will decay through the emission of beta particles as shown in Fig. 2. Those electrons having sufficient energy to permanently escape from the emitter give rise to a current that can be measured. Since the current is

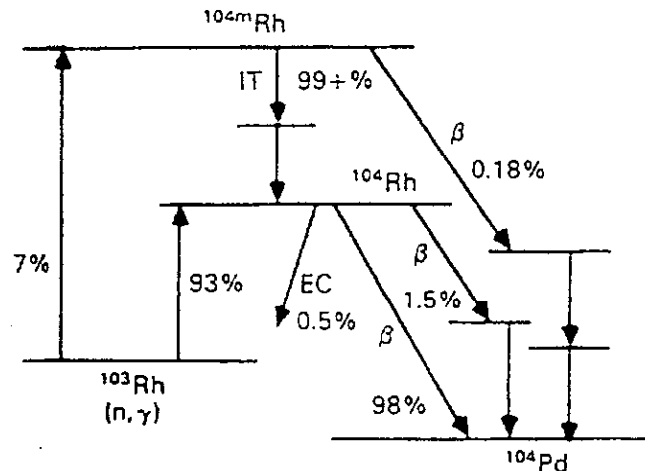

Fig. 2. Decay scheme of rhodium relevant to SPND.

produced from neutrons being absorbed in the rhodium, the magnitude of the current is proportional to the magnitude of the neutron flux at steady state.

The current from an RSPND can be written in terms of the processes that lead to production of energetic

Simulations of the Gentilly-2 Reactor During a Postulated Simultaneous Pressure Tube-Calandria Tube Rupture Event

J. Koclas*, A. Baudouin, M. Garceau, G. Hotte, C.H. Nguyen
Hydro-Québec, Section Analyse

June 29, 1992

1 INTRODUCTION

The effectiveness of the shutdown systems of the G2 reactor was analyzed for a postulated simultaneous rupture of a pressure tube and calandria tube occurring when relatively important soluble poison concentrations (such as Boron and Gadolinium) are present in the moderator. Such concentrations occur when restarting the reactor after a rather long outage, ie. longer than one day. The soluble poisons are used to compensate the absence of parasitic fission products, such as Xenon, and the build-up of Plutonium.

The purpose of this analysis is to determine the maximum allowable poison concentration, as a function of reactor power, to avoid exceeding the limits of safety system effectiveness for a pressure tube-calandria tube rupture. The methodology is similar to the one used previously by Ontario Hydro in the analysis of the Bruce B station.

*Present Adress : IGE, Ecole Polytechnique de Montréal

2 POSTULATED EVENT DESCRIPTION

Should a severe channel rupture, defined here as a simultaneous pressure tube and associated calandria tube rupture, occur during a start-up, coolant will be discharged in the moderator at a rate of about 220 kg/sec. High pressure and increasing moderator level will cause the opening of the calandria rupture discs and discharge of the heavy water into the reactor building. Poison concentration in the core will decrease because poison free coolant will be mixed with the moderator. Also, some moderator will escape through the opened rupture discs, thereby entraining soluble poison in the process. This soluble poison loss will cause a positive reactivity increase of the core.

The isotopic purity of the coolant is usually lower than that of the moderator. The resulting mixture will thus have a lower isotopic purity than the initial moderator, and this results in a negative reactivity contribution.

Hot coolant discharged in the colder moderator will cause a bulk moderator temperature increase. This effect results in a positive reactivity contribution. Steam will be produced near the ruptured channel, giving negative reactivity, which is not taken into account here.

The net result of these effects is a positive reactivity ramp. The Reactor Regulating System (RRS) would normally attempt to maintain bulk reactor power at its full power setpoint, and zonal powers at their relative power setpoints, by filling the liquid zone compartments with light water. If this is not enough to hold power constant, then RRS will drive two or four absorbers rods (Mechanical Control Absorbers or MCA) ,in banks of 2, into the reactor.

If power increases despite these actions by RRS, or if the flux tilts caused by the MCAs being inserted at full power cause the fuel to approach its dryout power, then the Shutdown System number 1 (SDS1) would trip the reactor by dropping shut-off rods (SOR) into the core due to a Regional Over-Power (ROP) signal from in-core flux detectors. The SDS2 could also inject a poison solution into the core in response to its own ROP system. Other shutdown system parameters may also exceed their trip setpoints.

The ruptured pressure tube might impair nearby vertical guide tubes of MCA's and SOR's by pipe whip interactions. This will further diminish the total negative reactivity available to RRS. The possibility of occurrence of overpower is increased because of the axial and lateral flux tilts that are induced in this fashion.

3 ANALYSIS METHOD

In order to assess quantitatively the different effects mentioned in the previous section, many codes were used to perform the needed computations. The codes and their interactions are shown schematically on Figure 1.

The G2 specific version 2.01 [2],[3] of the SOPHT [1] code was used to obtain the Primary Heat Transport (PHT) system response following the break, and to calculate the coolant discharge rate into the moderator.

In order to maximize the coolant mass flow rate, a high flow channel was selected for this study. The channel break was postulated to occur in the axial center of the channel. Furthermore, all fuel bundles were removed from the channel in this computation, thus increasing the mass flow rate. The damping effects of the moderator mass on the coolant discharge was neglected by assuming the discharge to occur to the atmosphere.

The discharge rate, and the discharged coolant enthalpy, as calculated by SOPHT, were then fed to the COMETES [6] code, which calculates the G2 moderator system response. The bulk moderator temperature is obtained by a mass and energy balance. The moderator level is calculated dynamically, and D₂O reaching the rupture discs level is removed from the moderator system. Soluble poison concentrations in the calandria are calculated with a piston model, which assumes that the coolant and moderator do not mix, and that only poisoned moderator is discharged. This releases a maximum amount of poison with the escaping moderator. Moderator isotopic concentration is obtained in the same fashion.

The SMOKING2 [4],[5] code calculates the neutronic response of the reactor, including detailed RRS actions. Reactivity effects of changes in poison concentrations and isotopic concentration are calculated with the POWDERPUF-V code. Moderator temperature changes are treated in the same way. Coolant density and fuel temperatures from SOPHT are transformed into modal reactivities directly in SMOKING2. Only two MCA's are available in this analysis, because two guide tubes are supposed impaired by pipe whip from the ruptured channel. Furthermore, the average zone level was supposed to be at 70% at the beginning of the rupture event, in order to minimize RRS capability to compensate the reactivity ramp.

The reactor power excursion thus obtained by SMOKING2 is then fed to SOPHT, and the entire cycle of calculations is redone for more precise results.

The G2 specific version [?] of the MINISOPHT [1] code calculates transient coolant flow in a specific hot channel, given inlet and outlet header boundary conditions from SOPHT, and the time-varying channel power of SMOKING2. The axial power shape is treated as constant in these calculations, since it was found to vary little in the high power channels of interest. This set of calculations is done only for the channels presenting the highest possibilities of reaching dry-out conditions. The first occurrence of sheath dry-out is determined using a 37 element critical heat flux correlation [8]. Maximum sheath temperature is obtained for the hot pin of the fuel bundle, taking into account the radial power distribution inside the fuel bundle.

Regional OverPower trip times are calculated by SMOKING2, while Shut-Down SDS1 and SDS2 process trips, such as Low Pressurizer Level and Low Heat Transport Pressure are calculated by SOPHT.

If dry-out is predicted to occur before two trip parameter setpoints are reached on each of SDS1 and SDS2, the initial moderator poison concentration is reduced, and a full set of calculations is redone in order to determine the maximum allowable poison concentration for this particular initial power level. The whole exercise is then repeated at various initial reactor powers.

4 RESULTS

We describe here a simulation of the G2 reactor at 75% power, with 25mk of soluble poisons in the moderator, and a 0.2% isotopic difference between moderator and coolant.

Figure 2 shows the reactor power excursion. Coolant is discharged at an initial rate of 260 kg/sec, causing a positive reactivity ramp, which is compensated by RRS during 40 seconds, by the liquid zone controllers filling up, and by the two unimpaired MCA's which are being inserted. Finally the MCA's attain a depth sufficient to reverse reactivity and bring the power back to its initial value. The power reaches a maximum value of 110% at 100 seconds after event initiation.

The total discharge flow rate of the coolant, from both ends of the ruptured channel, shows a fast variation in the first few seconds following the break, which corresponds to channel depressurisation. The mass flow rate stabilizes at about 220 Kg/second.

The pressuriser level as a function of time is shown on Figure 3. The trip

setpoint, which is power dependant, is also shown there. It is assumed that the reactor power is identical to the power measurement used in dynamic trip setpoint determination. Initially, the level diminishes, corresponding to coolant loss. The power increase causes coolant swelling, producing a temporary increase in level. The level eventually decreases after the power returns to its initial value.

Moderator level increases rapidly during the first 40 seconds, and stays constant thereafter, because moderator then leaves the calandria by the rupture discs. Figure 4 shows the inlet, outlet and average temperatures of the moderator. During the 210 seconds shown, there is a 33 ° C increase in average temperature. This corresponds to a 2.3mk reactivity contribution at the end of the transient.

The soluble poison concentration (in mk) varies linearly as a function of time. A 4.25mk contribution is obtained over the simulation period. Moderator isotopic concentration also varies linearly and contributes -1.25mk during the same 210 seconds. This value is based only on the 0.2 atom% initial difference between PHT and moderator isotopics. It is usually larger in normal operation.

Generally, the zones located in the bottom of the calandria show stronger power excursions than the zones located near the top of the core. This is due to the insertion of MCA's, which are located in the top zones during the whole transient, as shown on Figure 5. The MCA's are inserted by RRS control (and not via a stepback), with a speed determined by the power error. The power excursion of zone 5 is shown on Figure 6. It shows a stronger transient, going from 75% to 123%, than the total power which varies from 75% to 110%.

The low pressuriser level trip setpoint is reached 46 seconds in the transient, while ROP trip occurs at 72 seconds. Three critical channels including high flow and low flow channels were chosen for analysis with MINISOPHT. The calculated minimum critical heat flux ratio for each of these channels show a substantial margin to dry-out during the period of time preceding trips by either SDS1 or SDS2.

A similar calculation was performed for the the reactor at 100% power (103% in the simulations) with 8mk of soluble poisons and 0.2% isotopic difference. The transient is milder than the preceding one because of the lower poison concentration. The reactor power remains constant, and only one MCA bank is sollicitated by RRS. ROP trip occur at 110 seconds while

low pressuriser level occurs at 125 seconds. Again, dry-out conditions are not attained in this situation.

The poison limit curve now applied at G2 is shown in Figure 7.

5 CONCLUSION

A series of calculations, such as those described in the preceding sections, can be performed to establish a safe operating envelope, specifying the maximum allowable power as a function of soluble poison concentrations. This envelope is such that the shutdown systems are fully effective in preventing fuel failures should a pressure tube-calandria tube rupture event occur during start-up.

References

- [1] Y.F. Chang et al. *A thermal-hydraulic system simulation model for the reactor, boiler and heat transport system (SOPHT)*. Ontario Hydro report CNS-37-2, September 1977.
- [2] S. Chapados, J. Wilson. *Manuel de l'utilisateur de SOPHT*. Hydro-Québec Report G2-RT-90-03, October 1990.
- [3] S. Chapados. *Description des données d'entrée pour SOPHT du modèle de Gentilly-2, version 2.05*. Hydro-Québec report G2-RT-91-11 (draft), May 1991.
- [4] M. Gold. *SMOKIN - A Family of codes for reactor space-time neutronics calculations based on modal kinetics- theory manual*. Ontario Hydro NSD report no 90133, September 1990.
- [5] S. Alaoui. *Guide de l'utilisateur de SMOKING2*. Hydro-Québec/Ecole Polytechnique report GAN-177, August 1987.
- [6] M. Garceau. *COMETES version 0.0, Comportement du modérateur en transitoire et à l'état stable, description générale*. Hydro-Québec report G2-RT-92-05 (draft), March 1992.
- [7] I. Beaulieu. *Rapport de conversion et d'implantation du logiciel SOPHTMINI-1A sur VAX*. Hydro-Québec/ENAQ report ENAQ-51, September 1991.
- [8] J.A. Lorenc. *Critical heat flux in 37 element fuel*. Ontario Hydro D&D report no. 85099, March 1985.

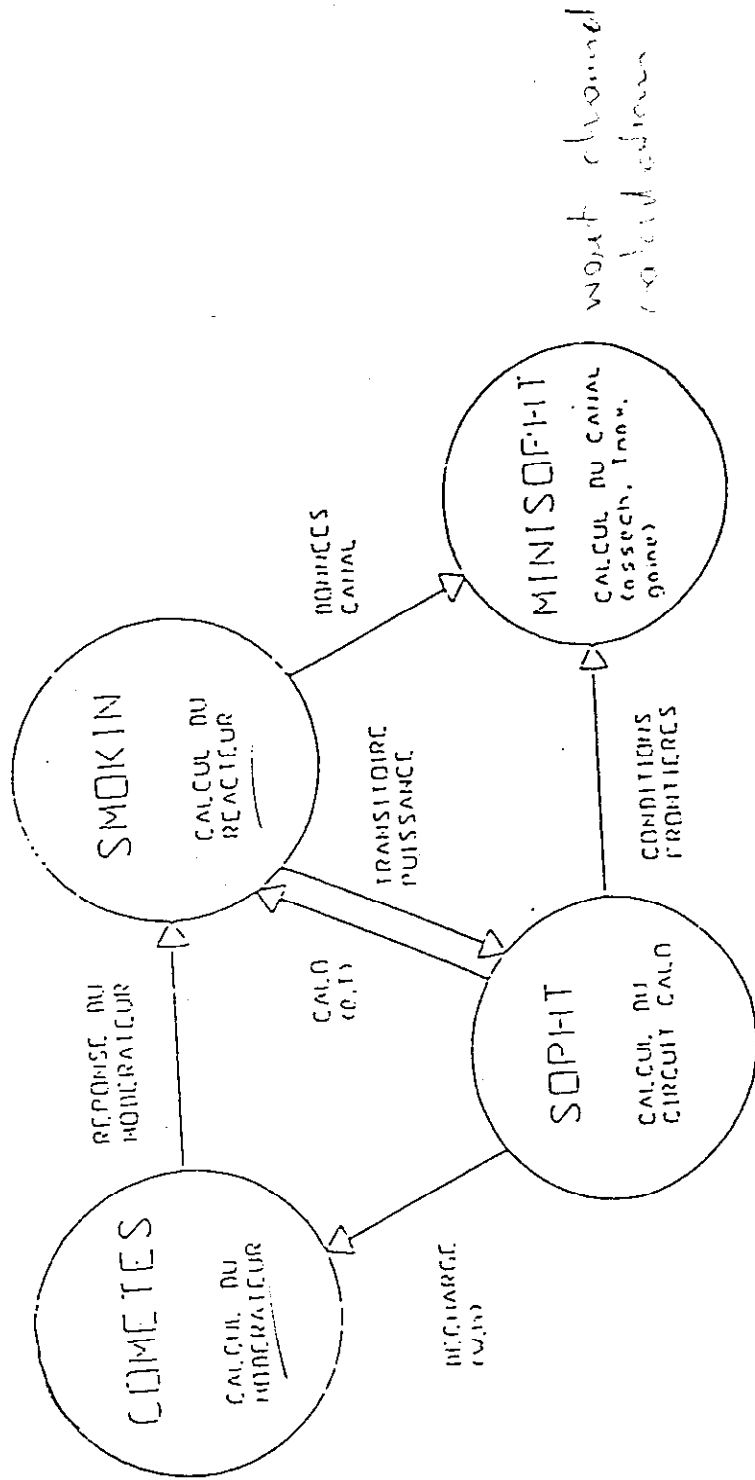

FIGURE 1
INTERACTIONS BETWEEN THE VARIOUS CODES

75% INITIAL POWER 25mk poison

GLOBAL POWER

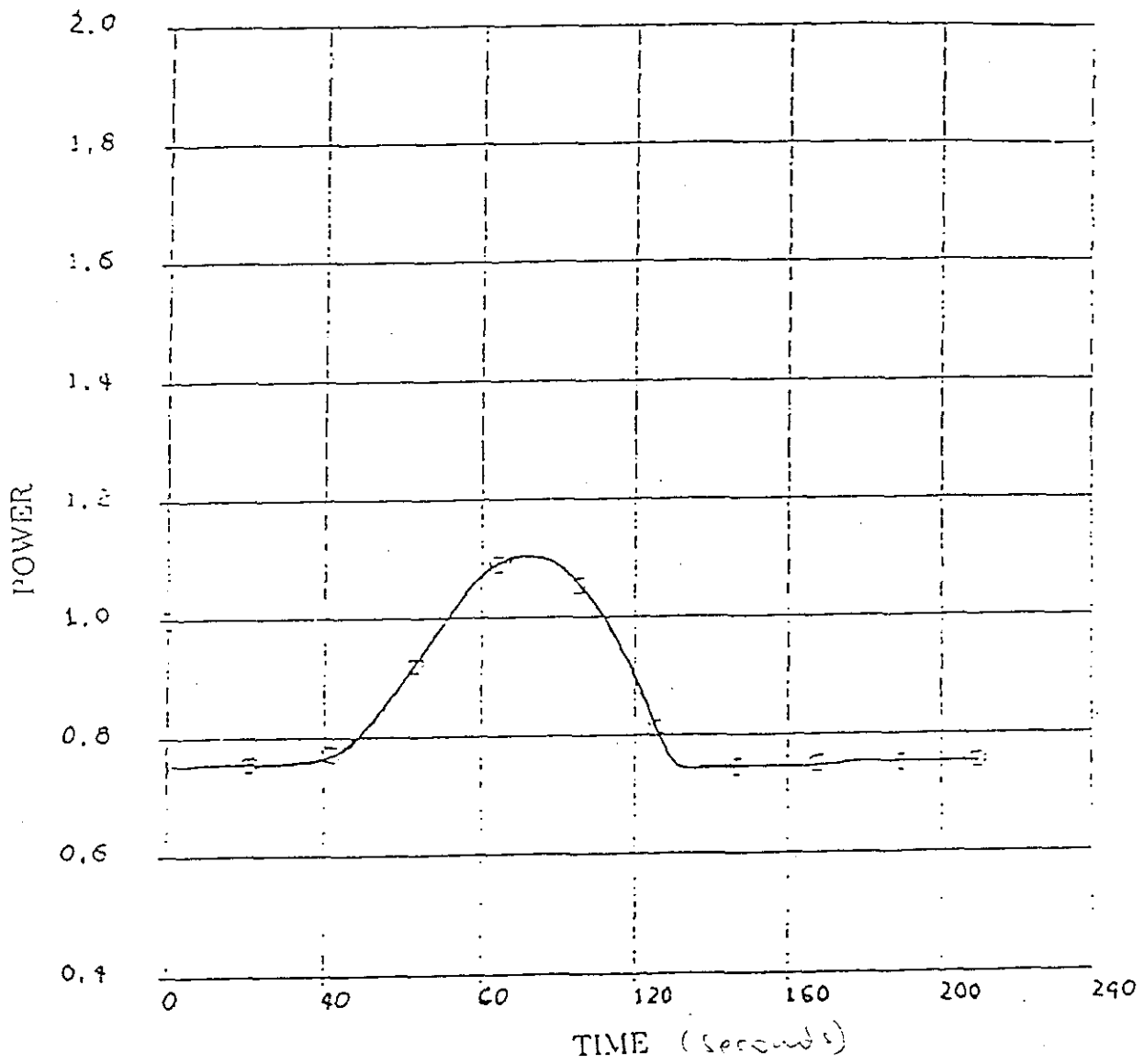

FIGURE 2

PRESSURISER LEVEL

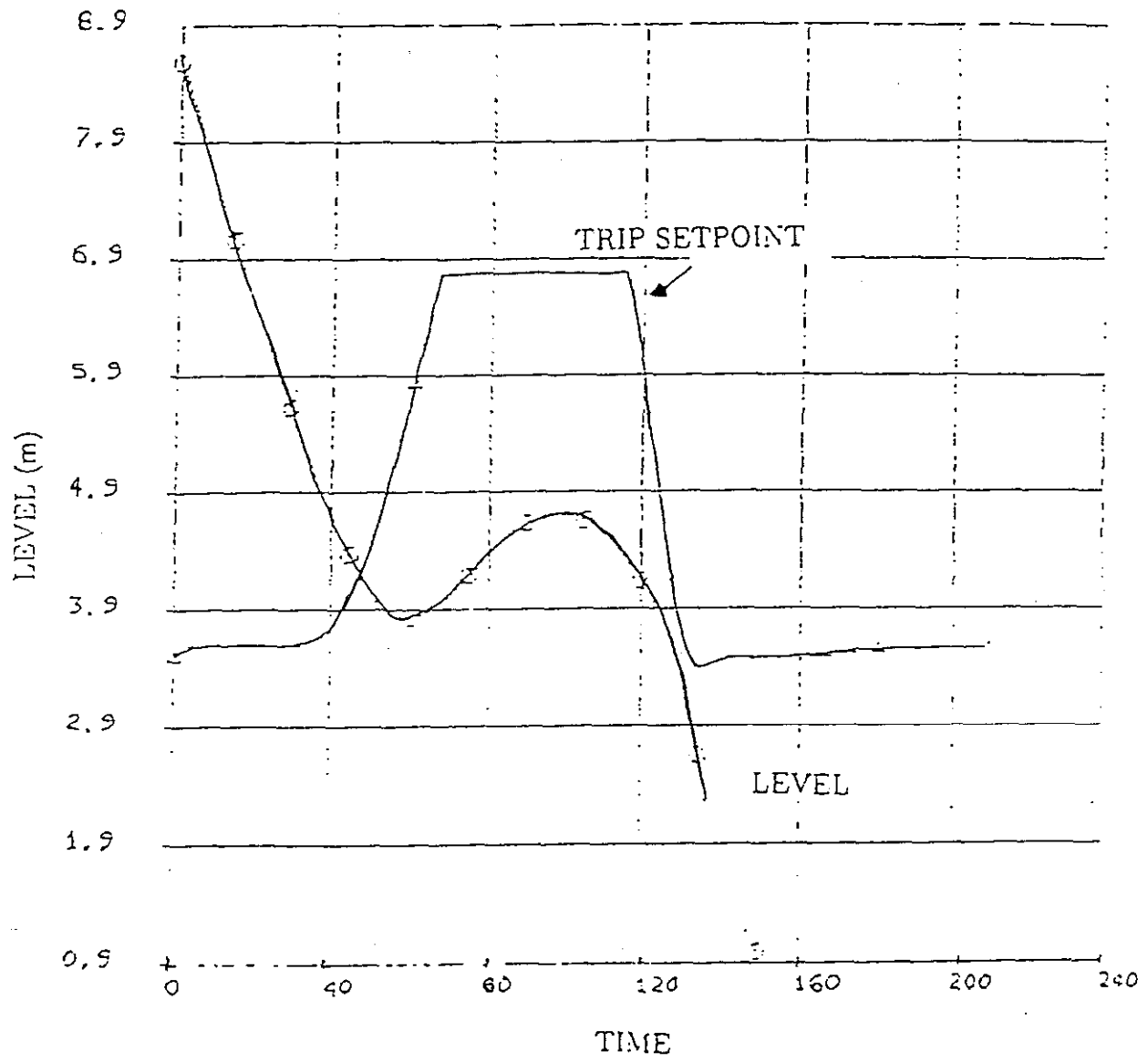

FIGURE 3

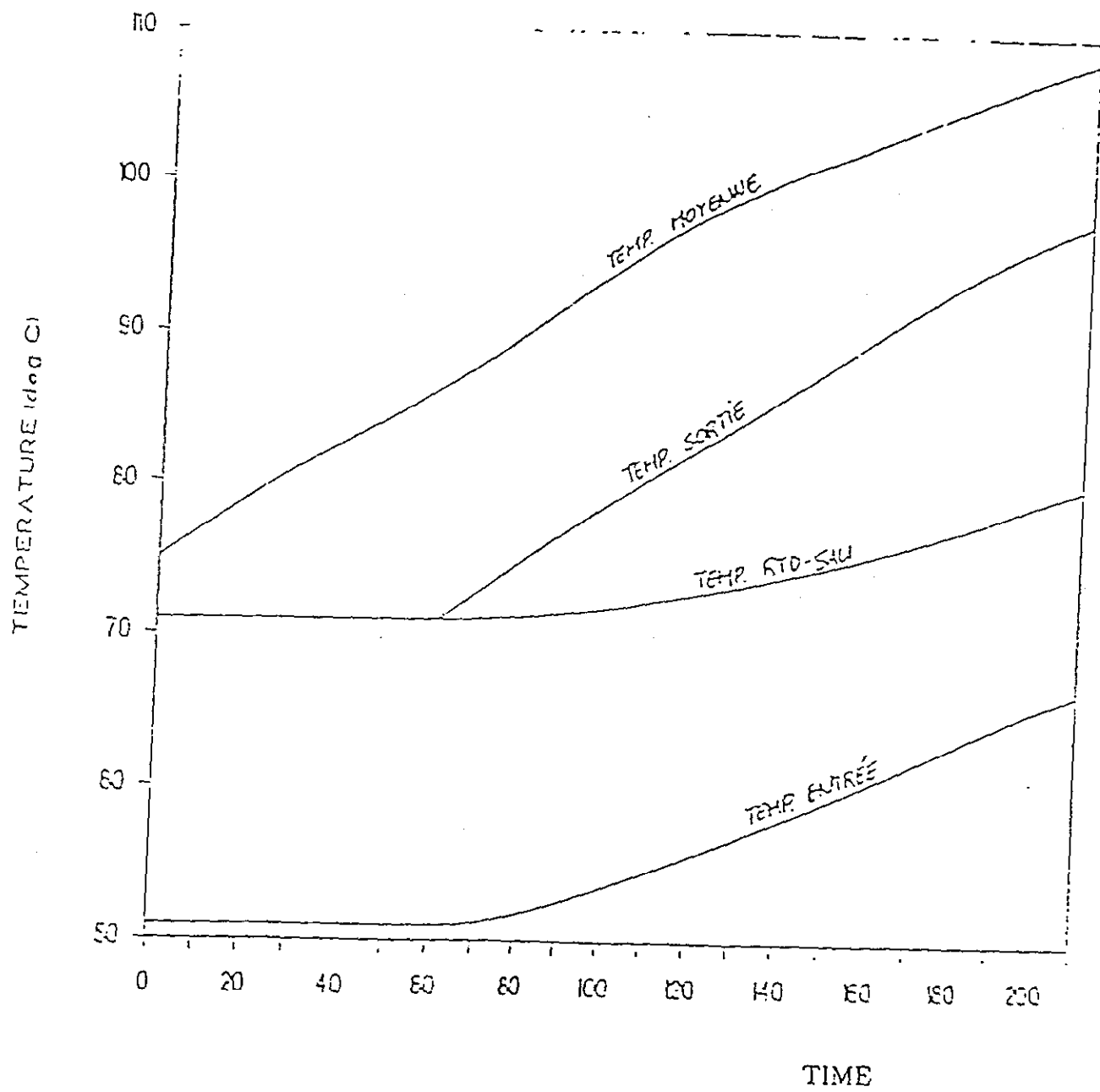

FIGURE 4

MCA #3 and #4 POSITIONS

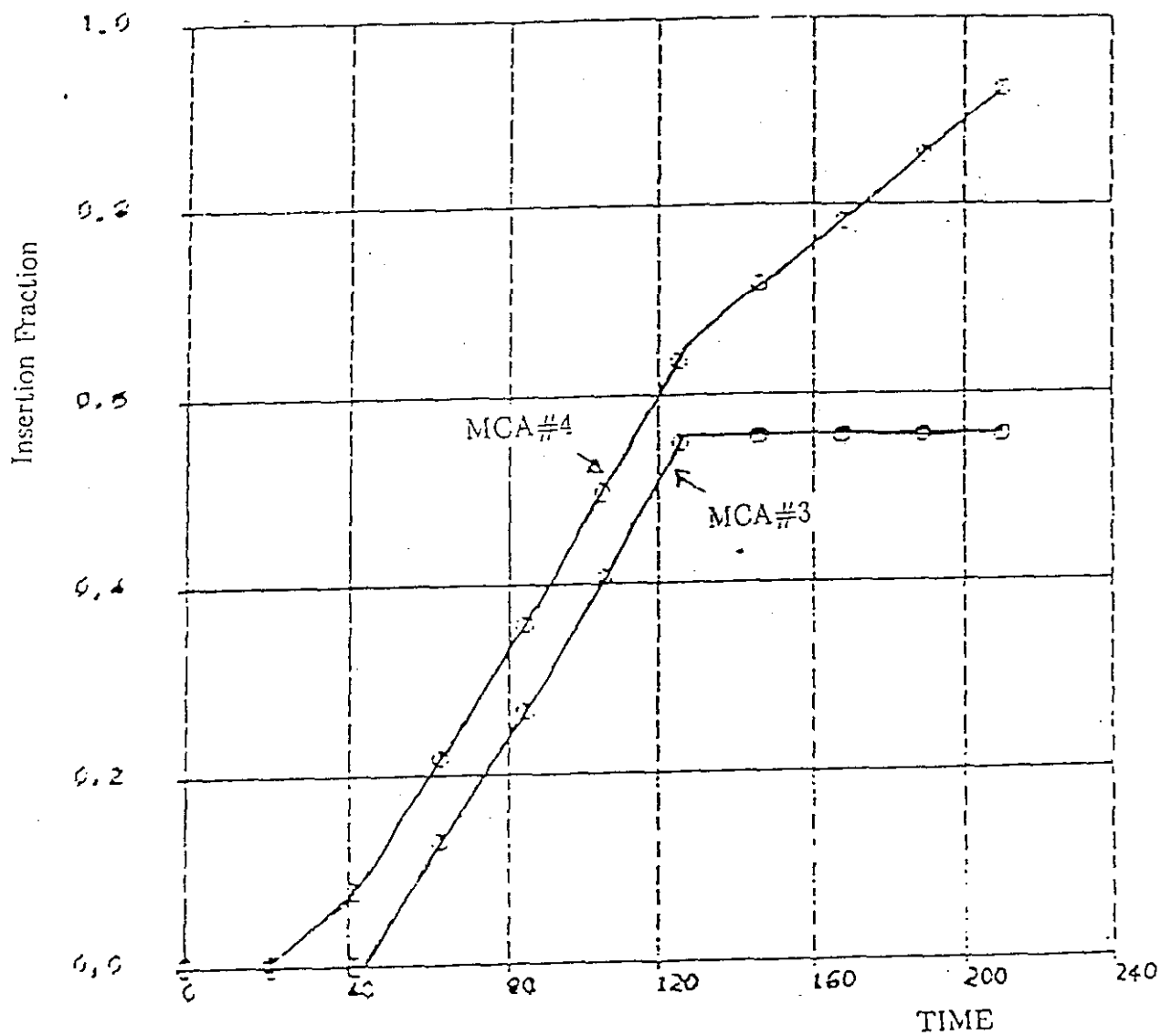

FIGURE 5

ZONE 5 CALIBRATED POWER

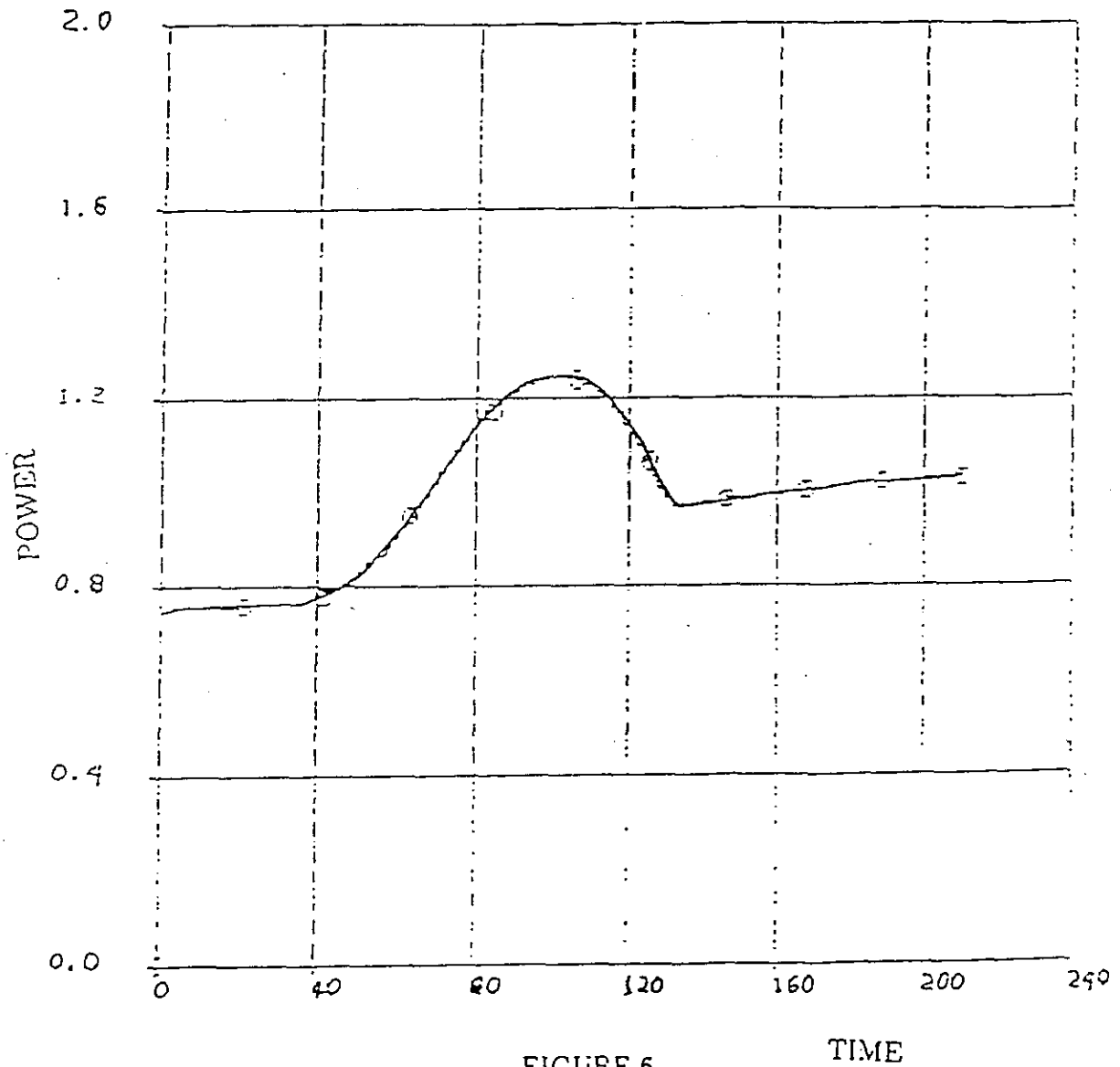

FIGURE 6

TIME

FIGURE 7

PUISSANCE MAXIMALE VS POISON SOLUBLE

