

IT ALL STARTED WITH WW II WHEN CANADA
WAS GIVEN THE JOB OF MAKING PLUTONIUM
USING D₂O MODERATED CRITICAL PILES.

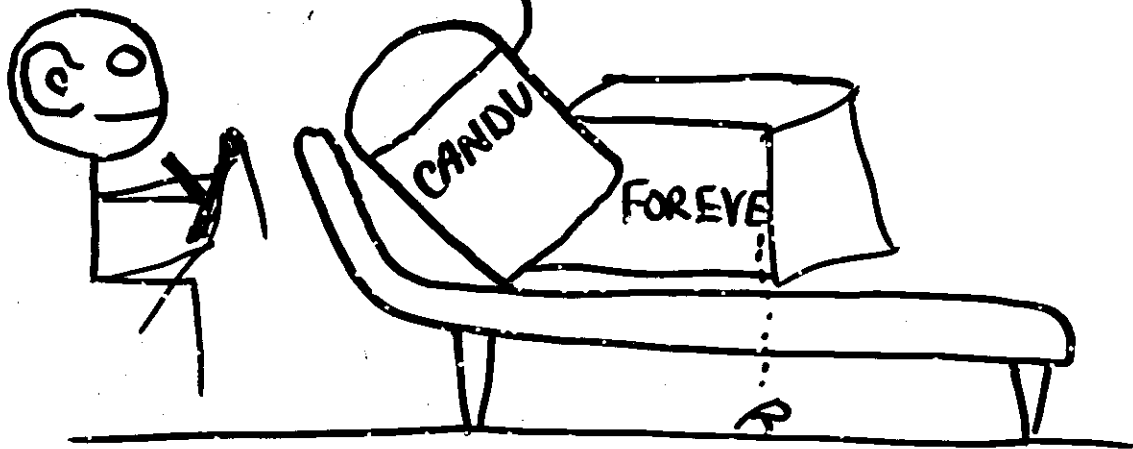

GET TO KNOW WHAT
YOU HAVE TO MODEL.

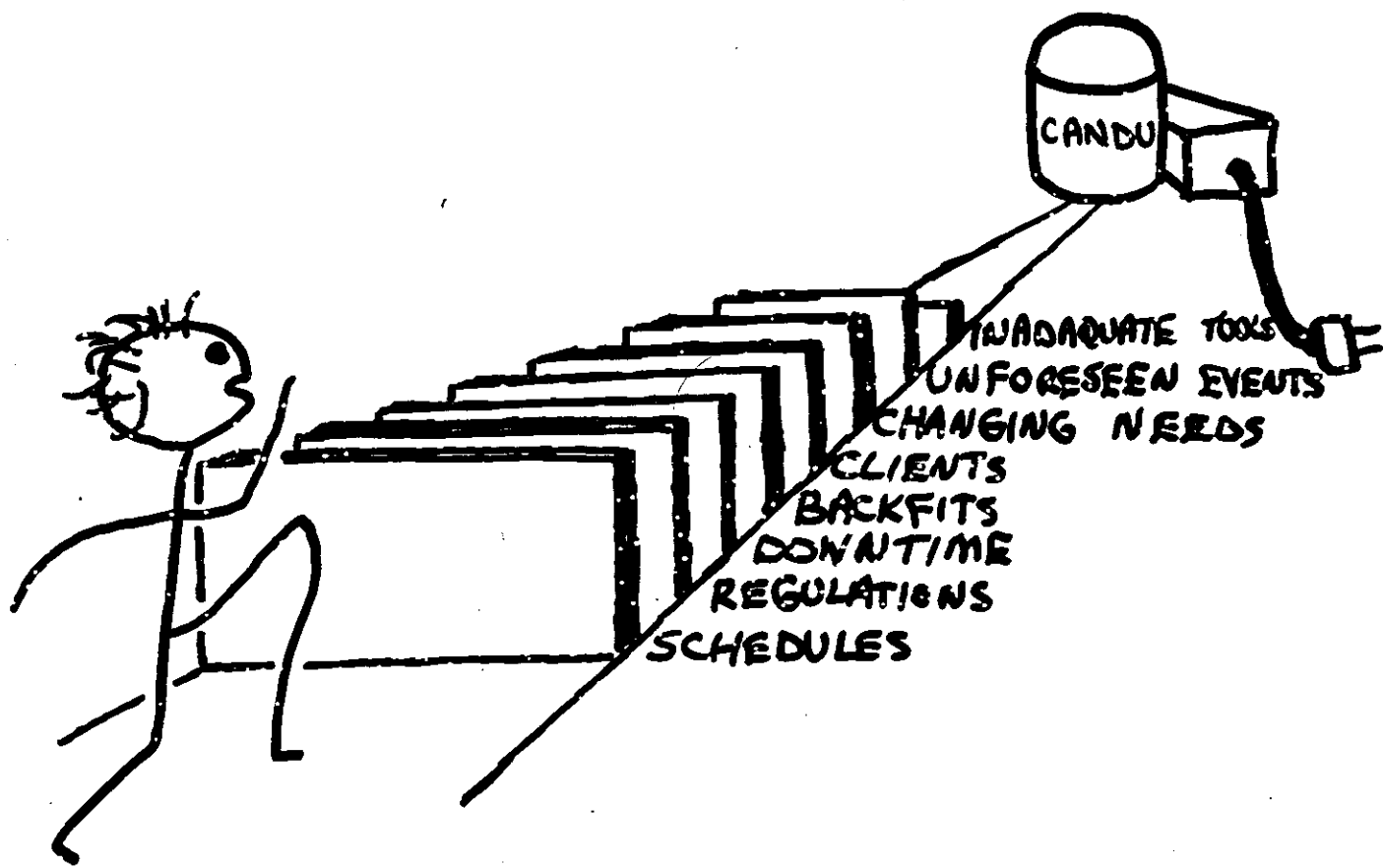

IN THE GREAT SCHEME
OF THINGS,
COMPUTATION IS NOT THE
DESIGNER / ANALYST'S
BIGGEST PROBLEM

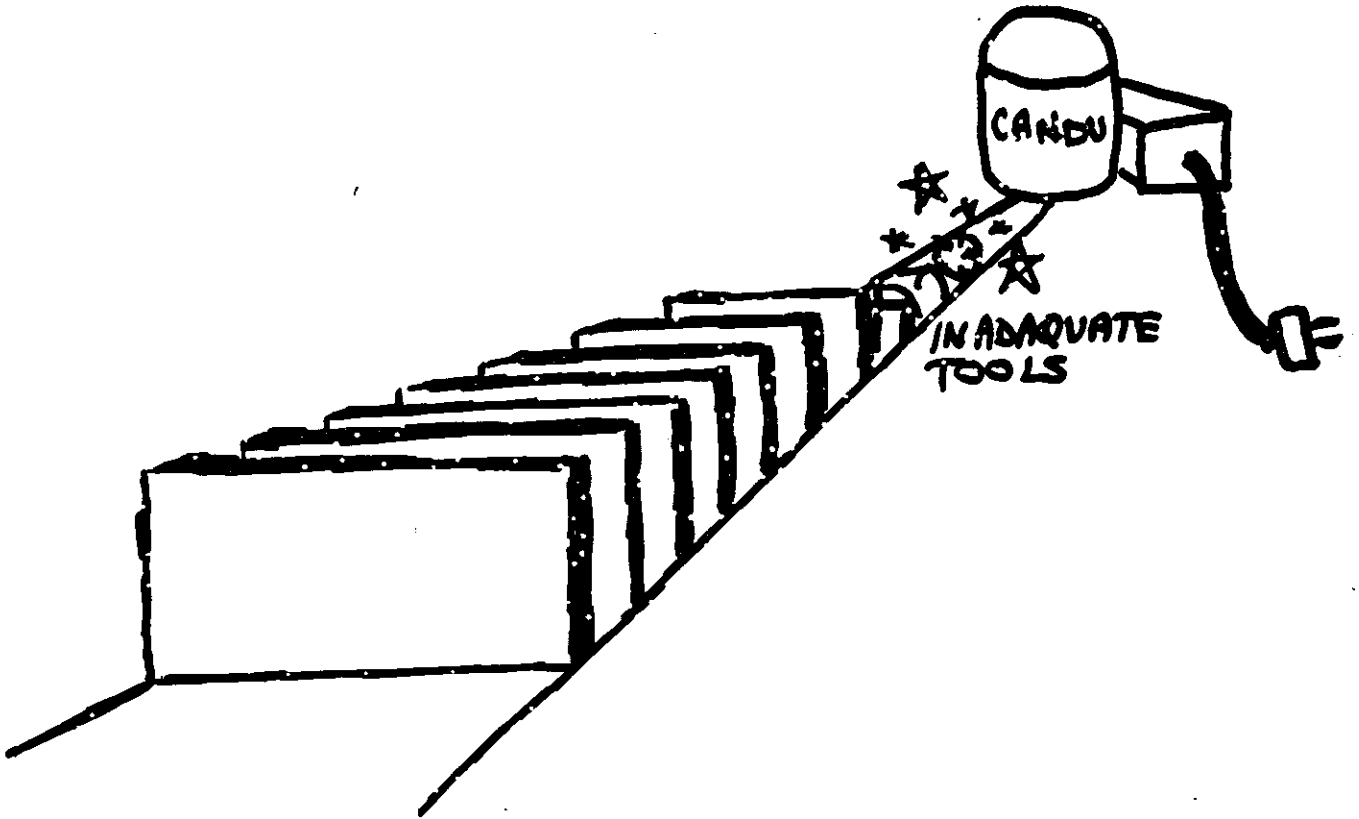

BUT IT CAN'T
BE IGNORED !

- THE ISSUES OF COMPUTATIONAL ACCURACY, SPEED, EFFICIENCY, CONVERGENCE, STABILITY, CONSISTENCY, ETC. ARE GENERALLY NOT MAJOR ISSUES — BECAUSE ADVANCES HAVE BEEN MADE IN THESE AREAS.
- THE PROBLEM IS USUALLY ONE OF ACHIEVING A DESIGN OR ANALYSIS THAT IS GOOD ENOUGH, ON TIME AND WITHIN BUDGET.

KNOWING HOW TO DO A
SPECIFIC TASK IS USUALLY
EASY.

"Herman . . . two is load . . . THREE is fire!"



KNOWING WHEN IS USUALLY
NOT SO EASY.

GENERAL STRATEGY :

- 1) ROUGH IN ENTIRE PROBLEM/SOLUTION
- 2) REFINE
- 3) ITERATE

THIS IS NOT SO DIFFERENT FROM ANY CONVERGENCE ALGORITHM.

SO WHY IS IT SO OFTEN IGNORED ?

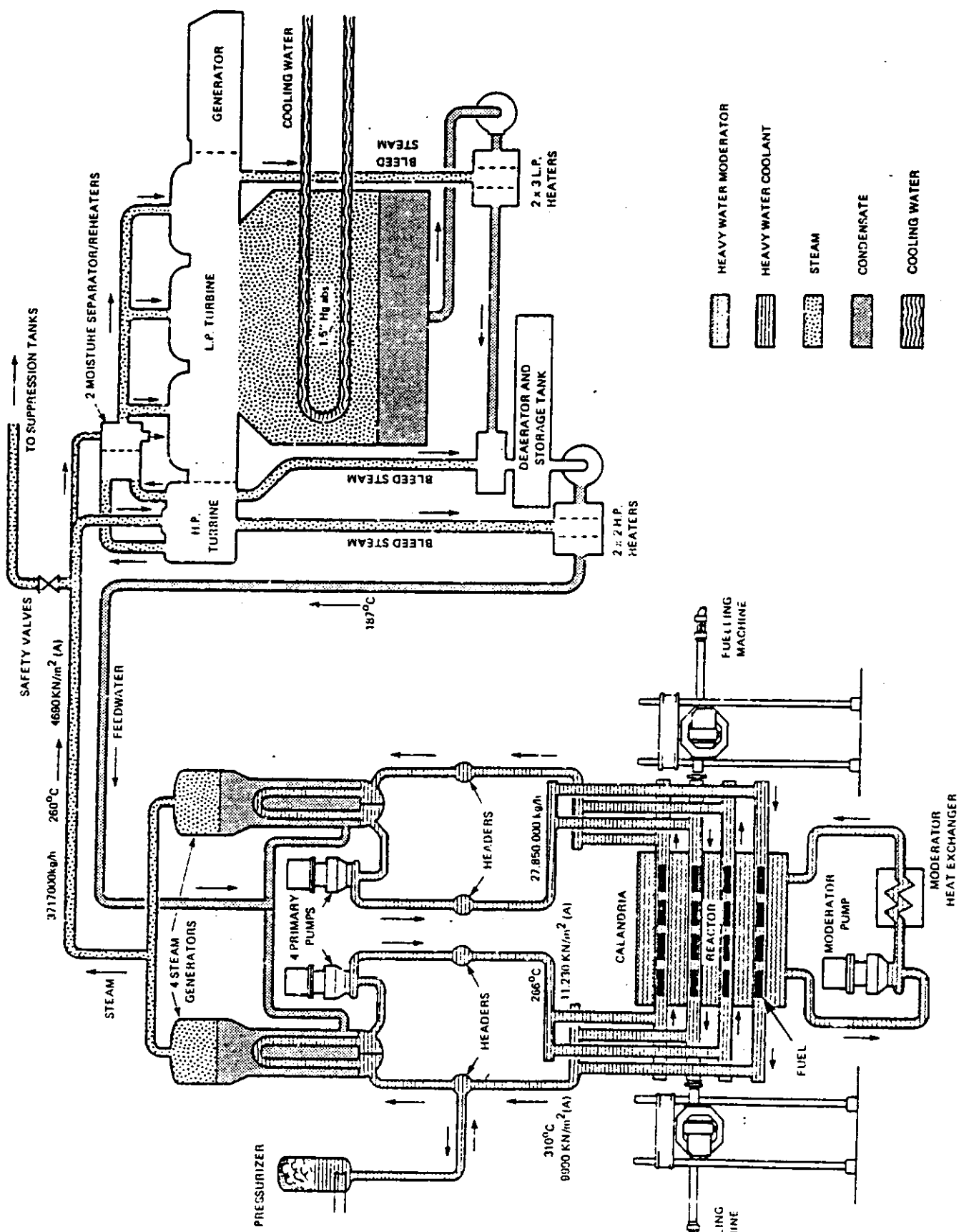

- HEAVY WATER MODERATOR
- HEAVY WATER COOLANT
- STEAM
- CONDENSATE
- COOLING WATER

FIGURE 1.1 CANDU NUCLEAR POWER SYSTEM

Some 40 process systems involving thermohydraulics.

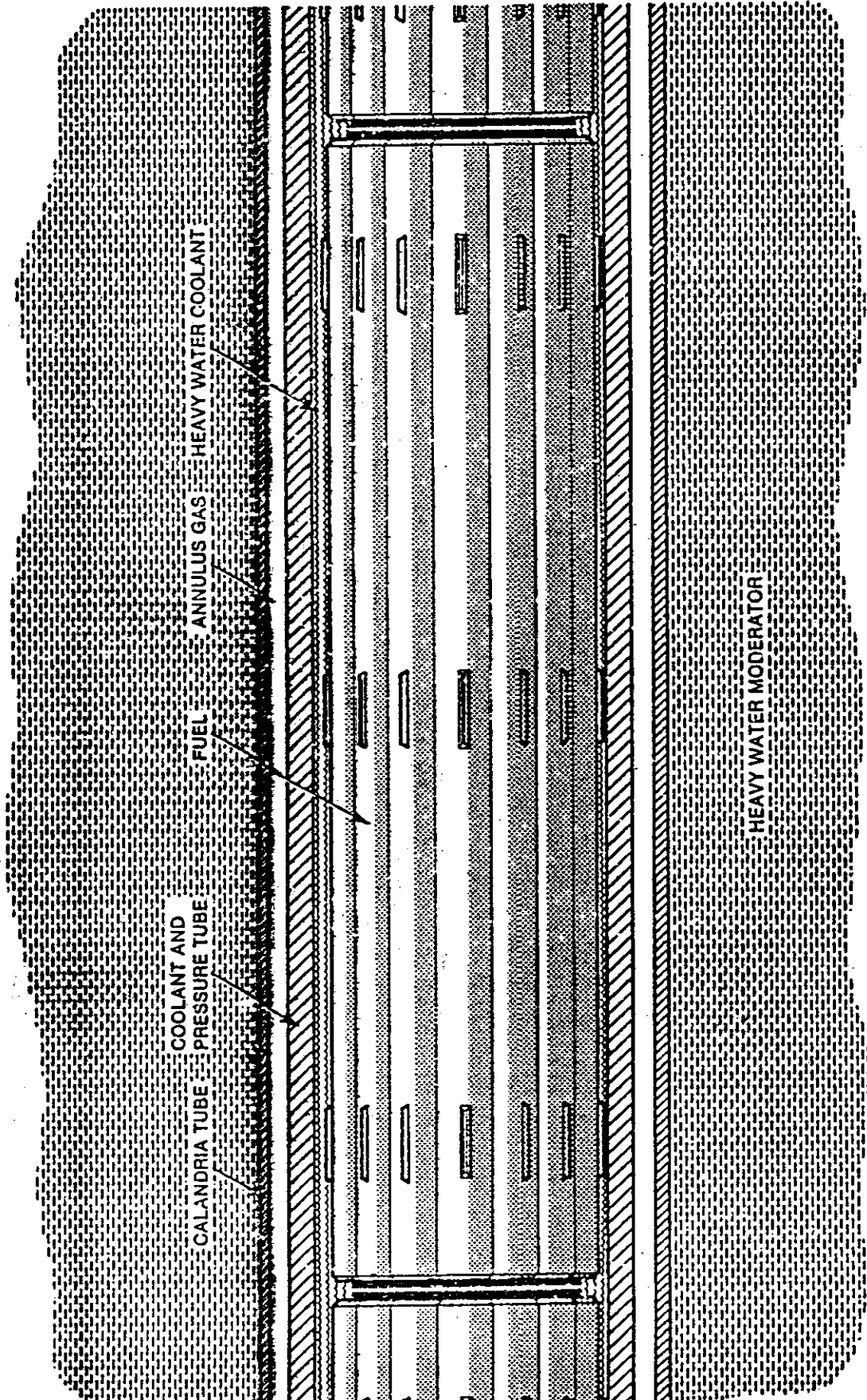

FIGURE 1.2 FUEL CHANNEL ARRANGEMENT

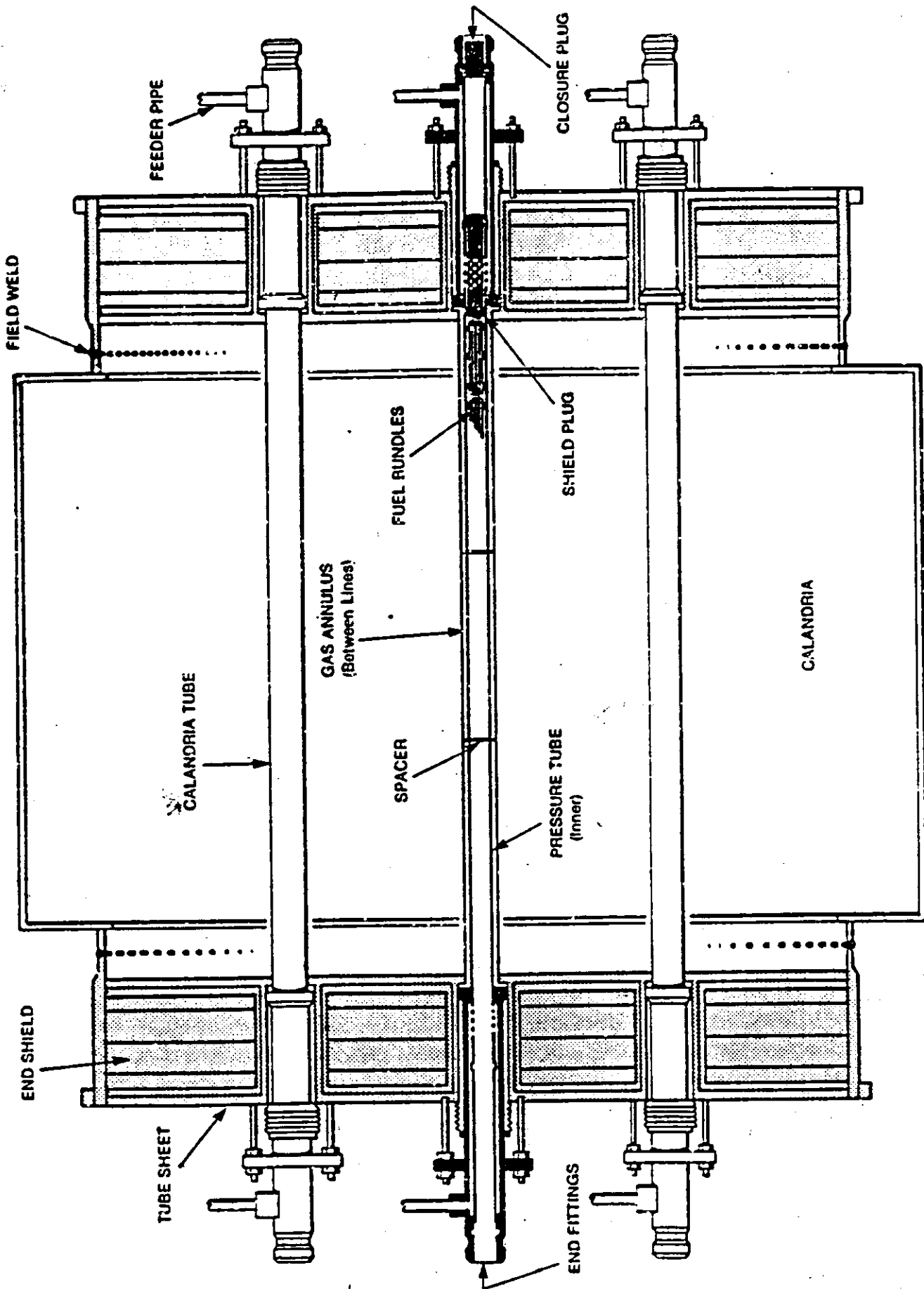

FIGURE 1.3 REACTOR CORE SCHEMATIC

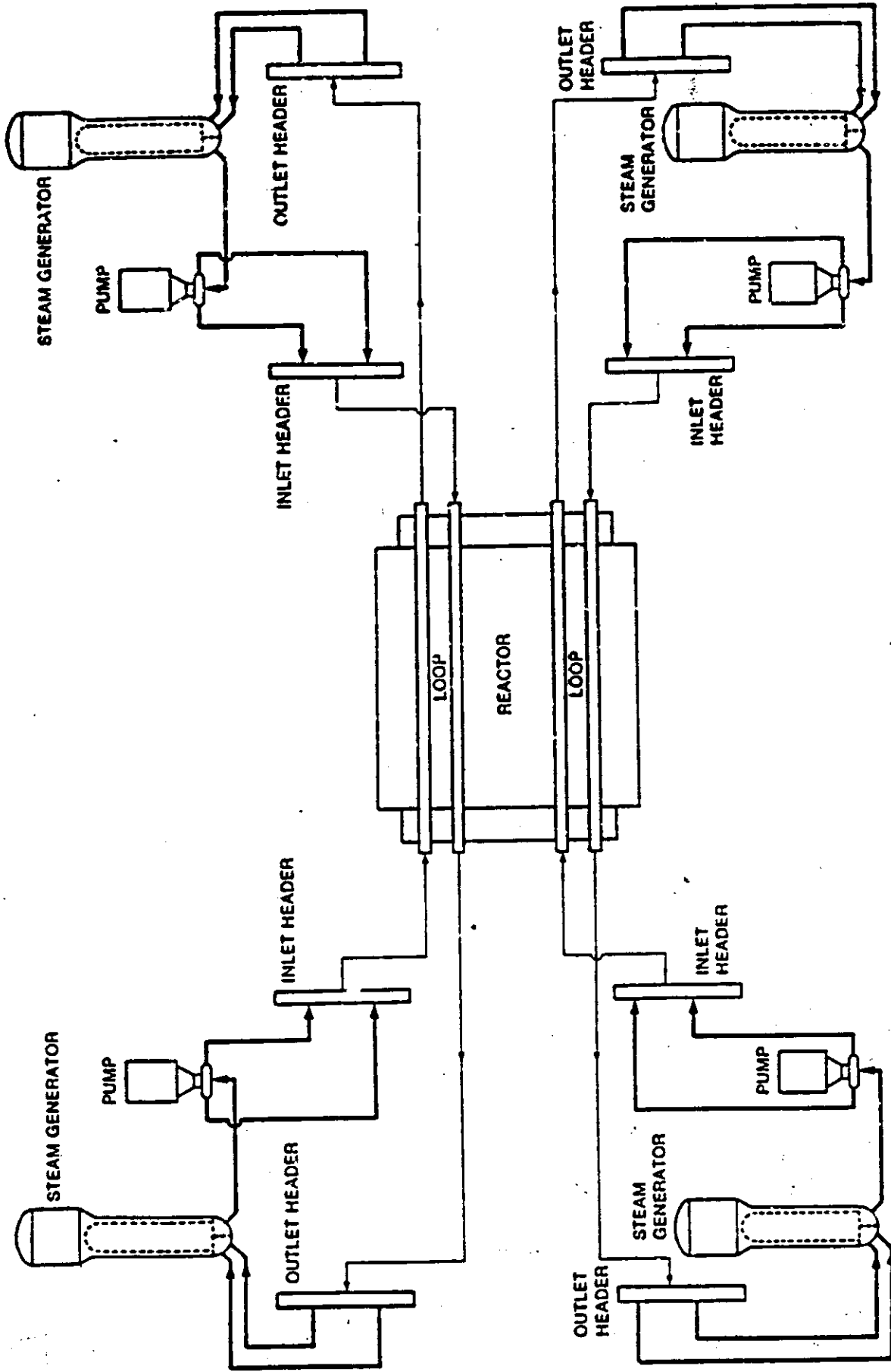
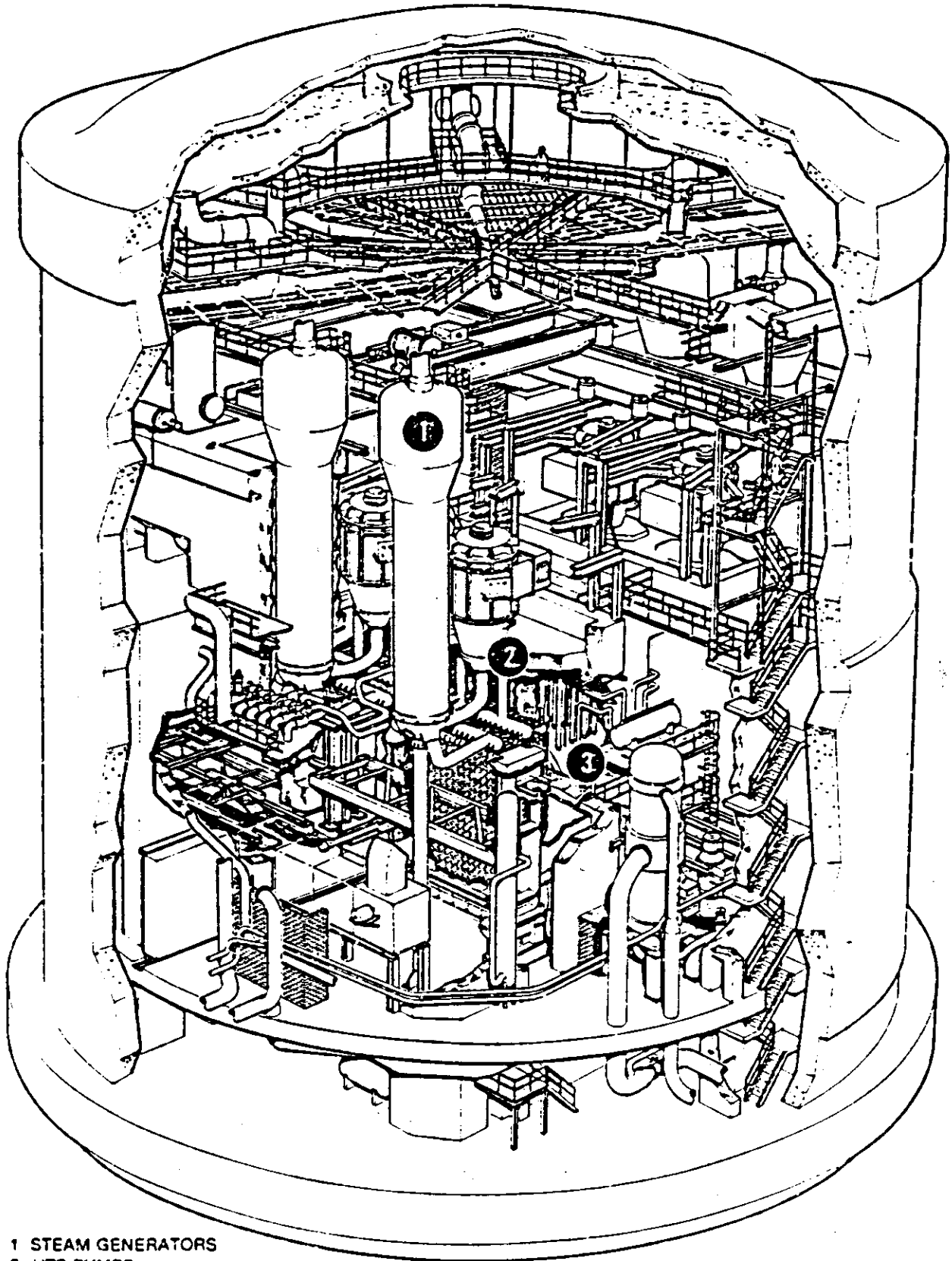

FIGURE 1.4 A HEAT TRANSPORT SYSTEM



- 1 STEAM GENERATORS
- 2 HTS PUMPS
- 3 REACTOR

FIGURE 1.5 . LOCATION OF HEAT TRANSPORT SYSTEM EQUIPMENT

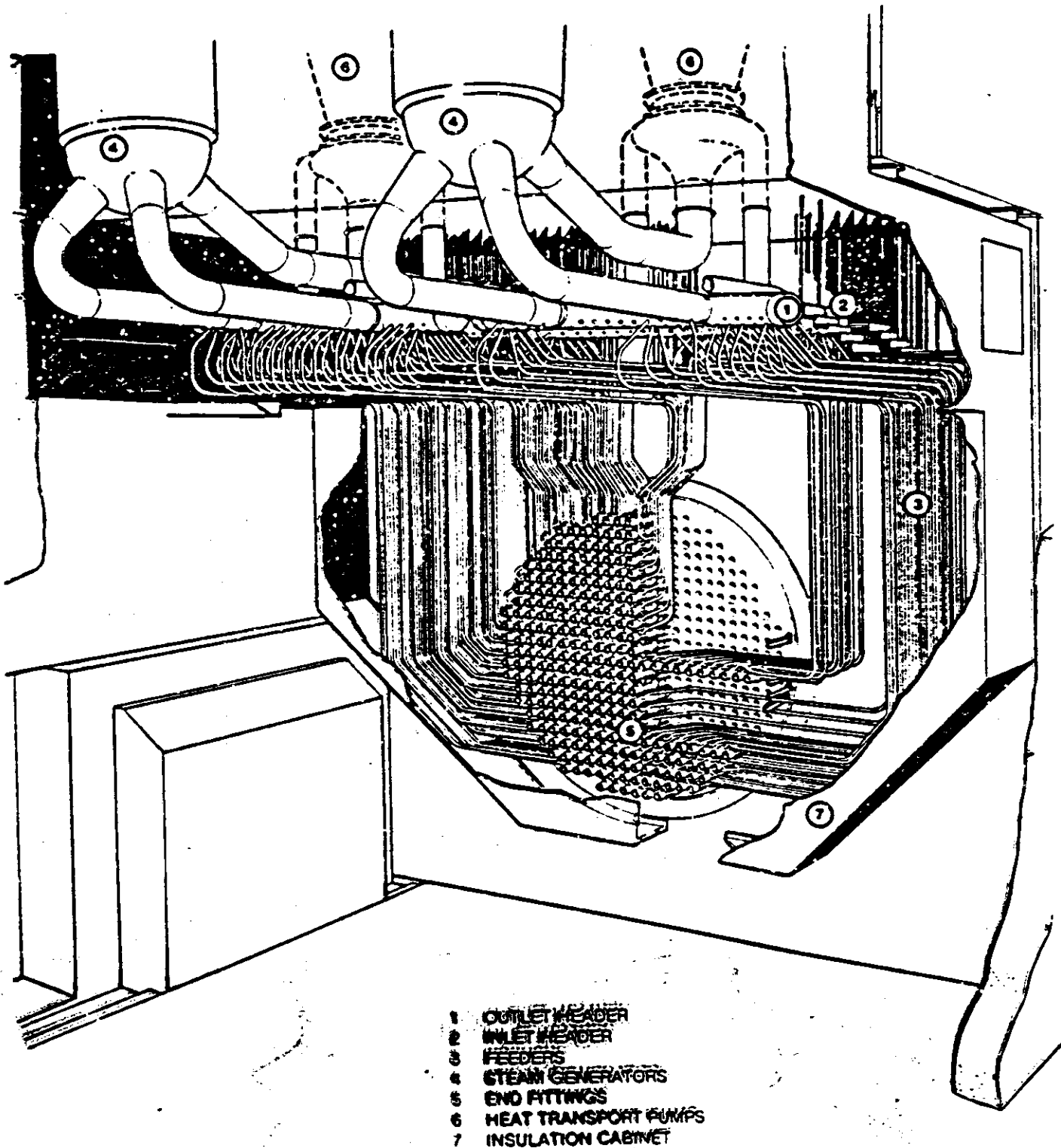

FIGURE 1.6 FEEDER AND HEADER ARRANGEMENT

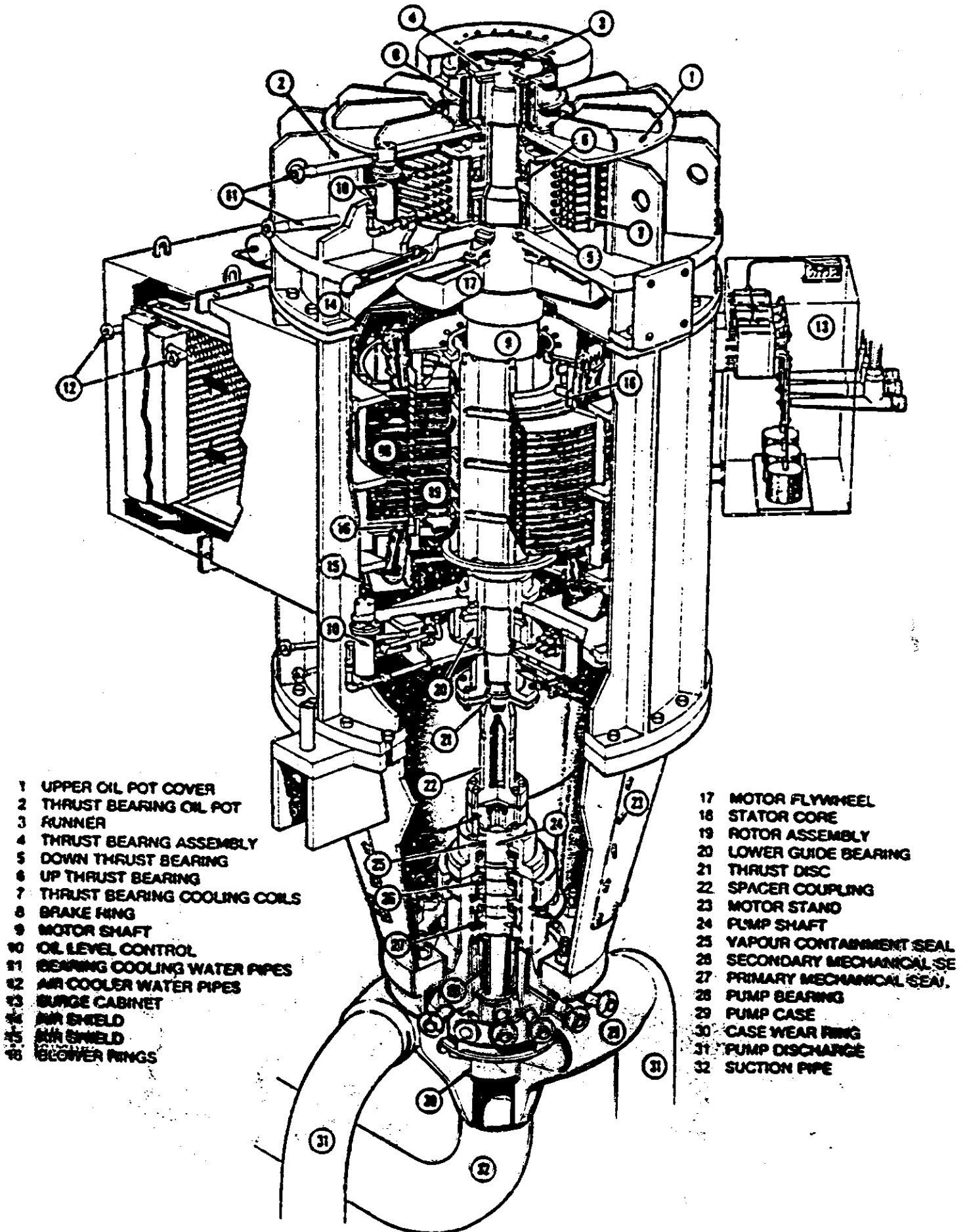
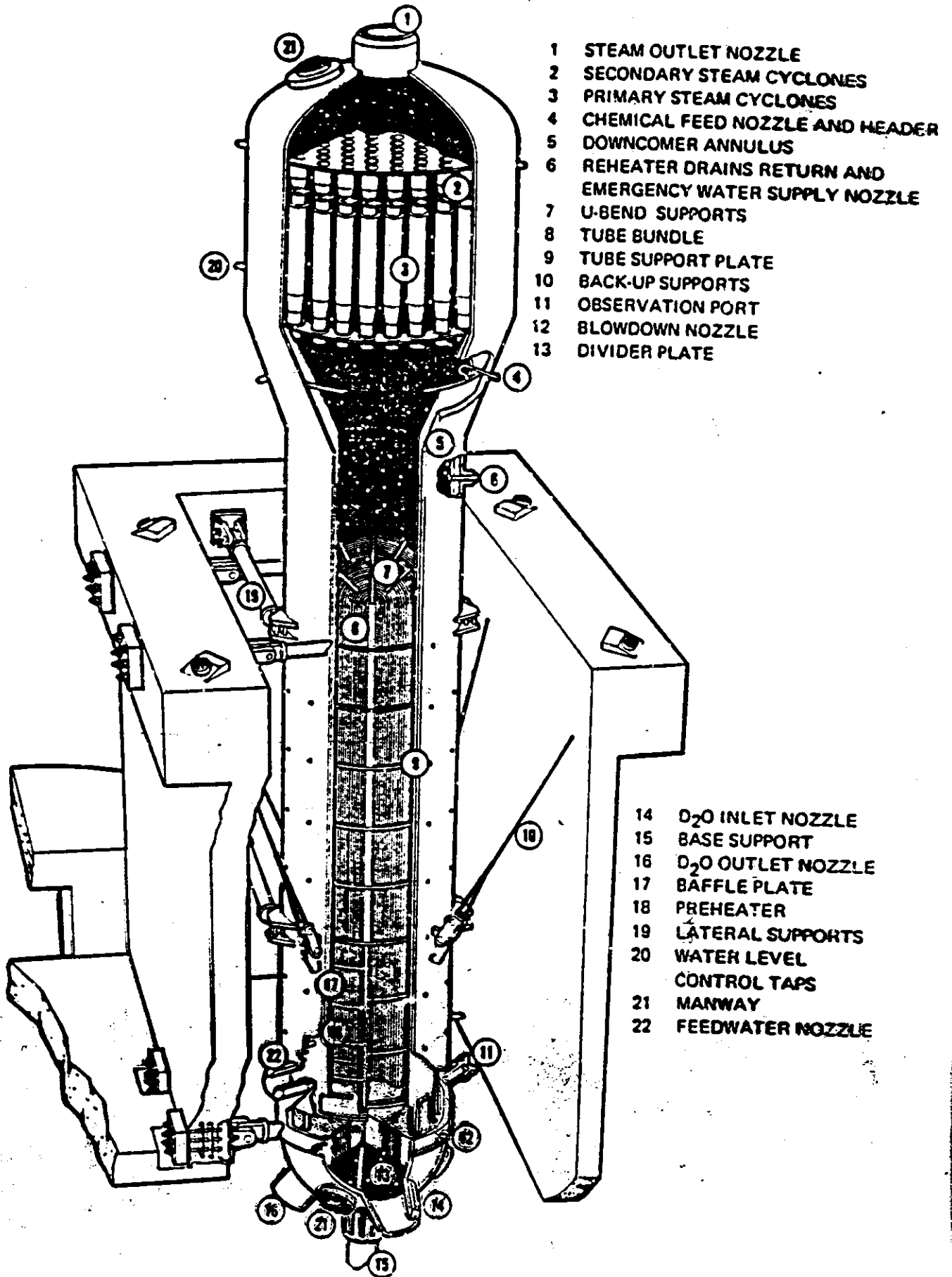

FIGURE 1.7 HEAT TRANSPORT SYSTEM PUMP



- 1 STEAM OUTLET NOZZLE
- 2 SECONDARY STEAM CYCLONES
- 3 PRIMARY STEAM CYCLONES
- 4 CHEMICAL FEED NOZZLE AND HEADER
- 5 DOWNCOMER ANNULUS
- 6 REHEATER DRAINS RETURN AND EMERGENCY WATER SUPPLY NOZZLE
- 7 U-BEND SUPPORTS
- 8 TUBE BUNDLE
- 9 TUBE SUPPORT PLATE
- 10 BACK-UP SUPPORTS
- 11 OBSERVATION PORT
- 12 BLOWDOWN NOZZLE
- 13 DIVIDER PLATE

- 14 D₂O INLET NOZZLE
- 15 BASE SUPPORT
- 16 D₂O OUTLET NOZZLE
- 17 BAFFLE PLATE
- 18 PREHEATER
- 19 LATERAL SUPPORTS
- 20 WATER LEVEL CONTROL TAPS
- 21 MANWAY
- 22 FEEDWATER NOZZLE

FIGURE 1.8 600 MW STEAM GENERATOR

CROSS-SECTION OF A TYPICAL STEAM GENERATOR

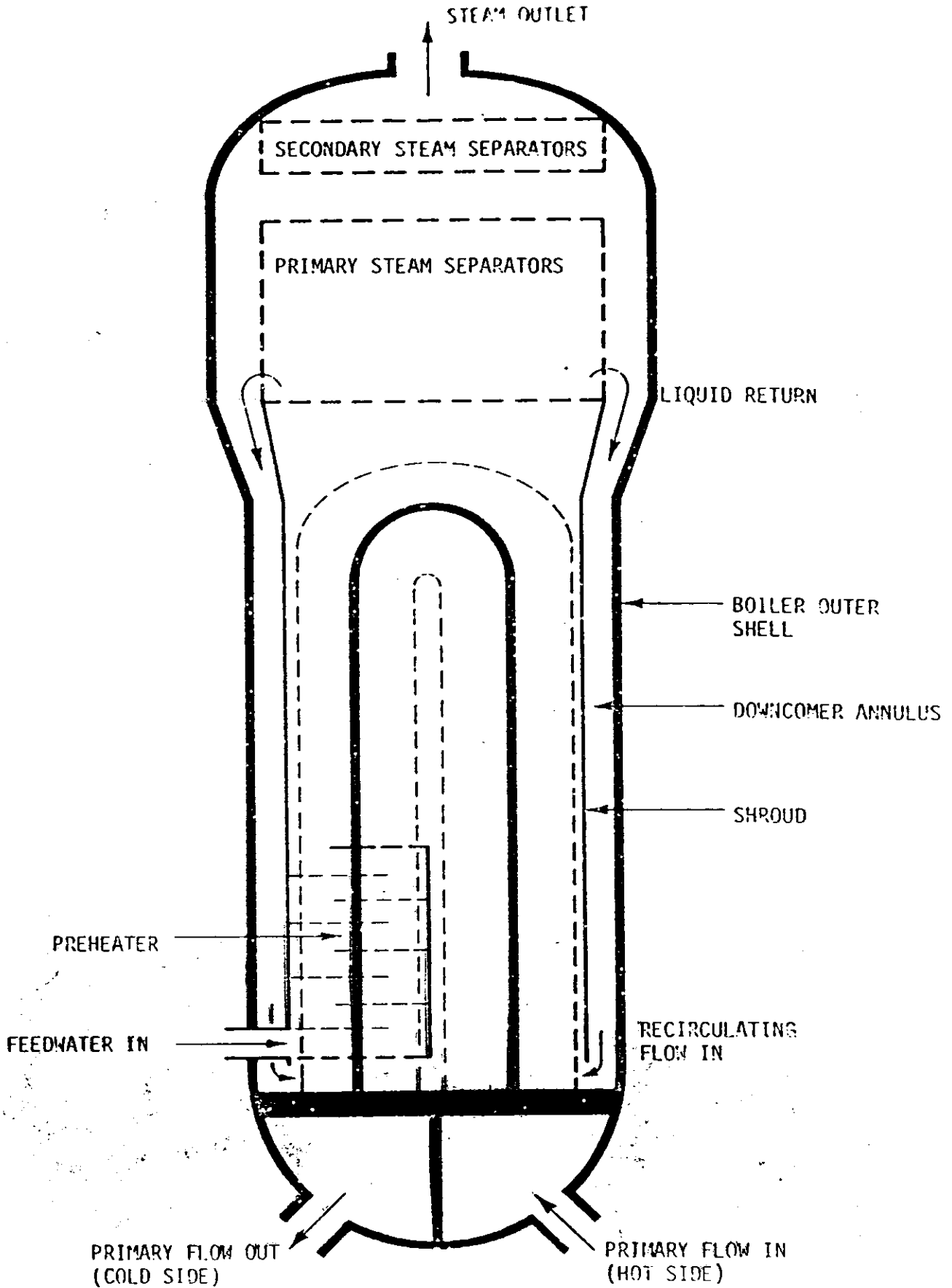

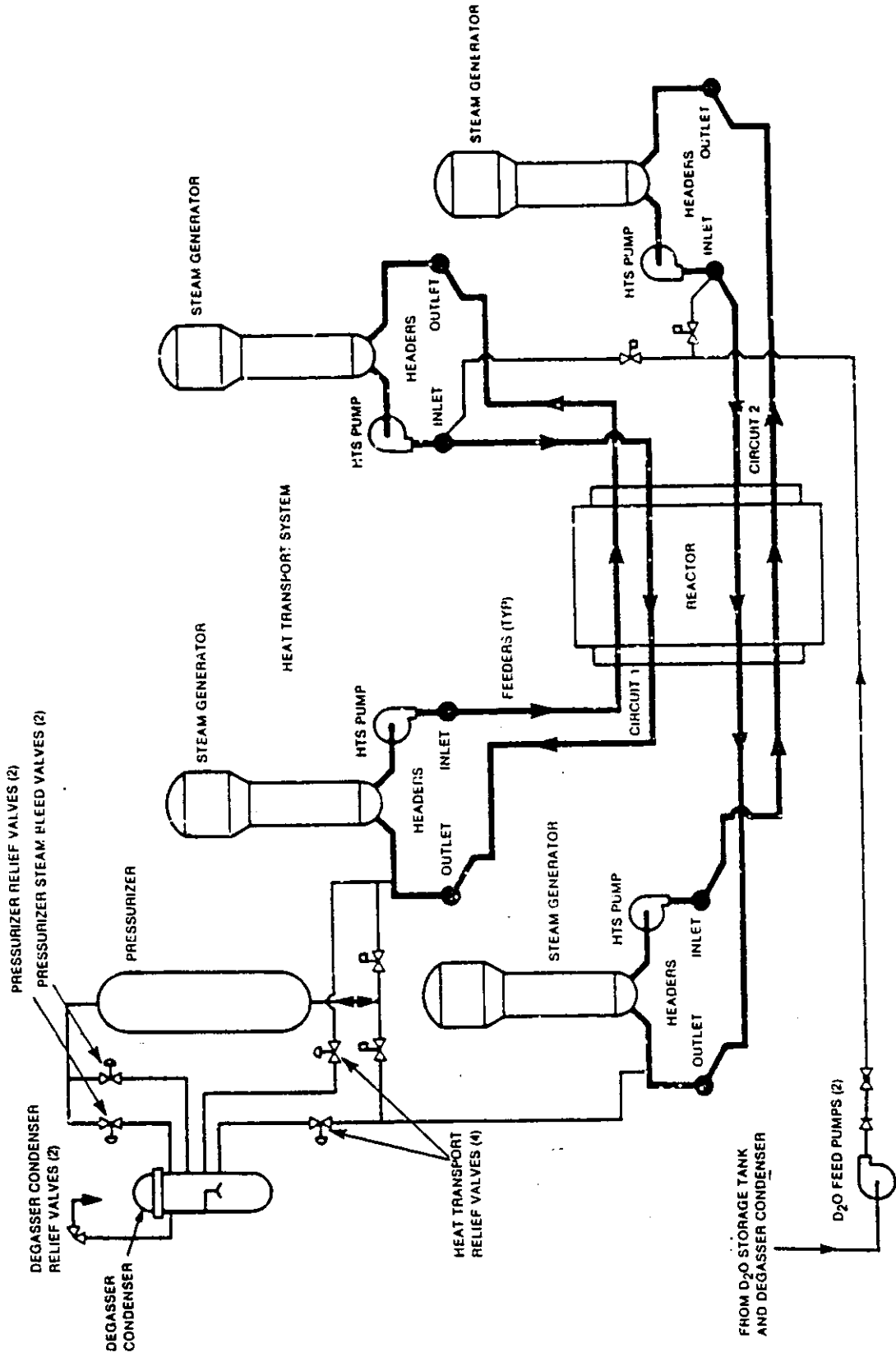
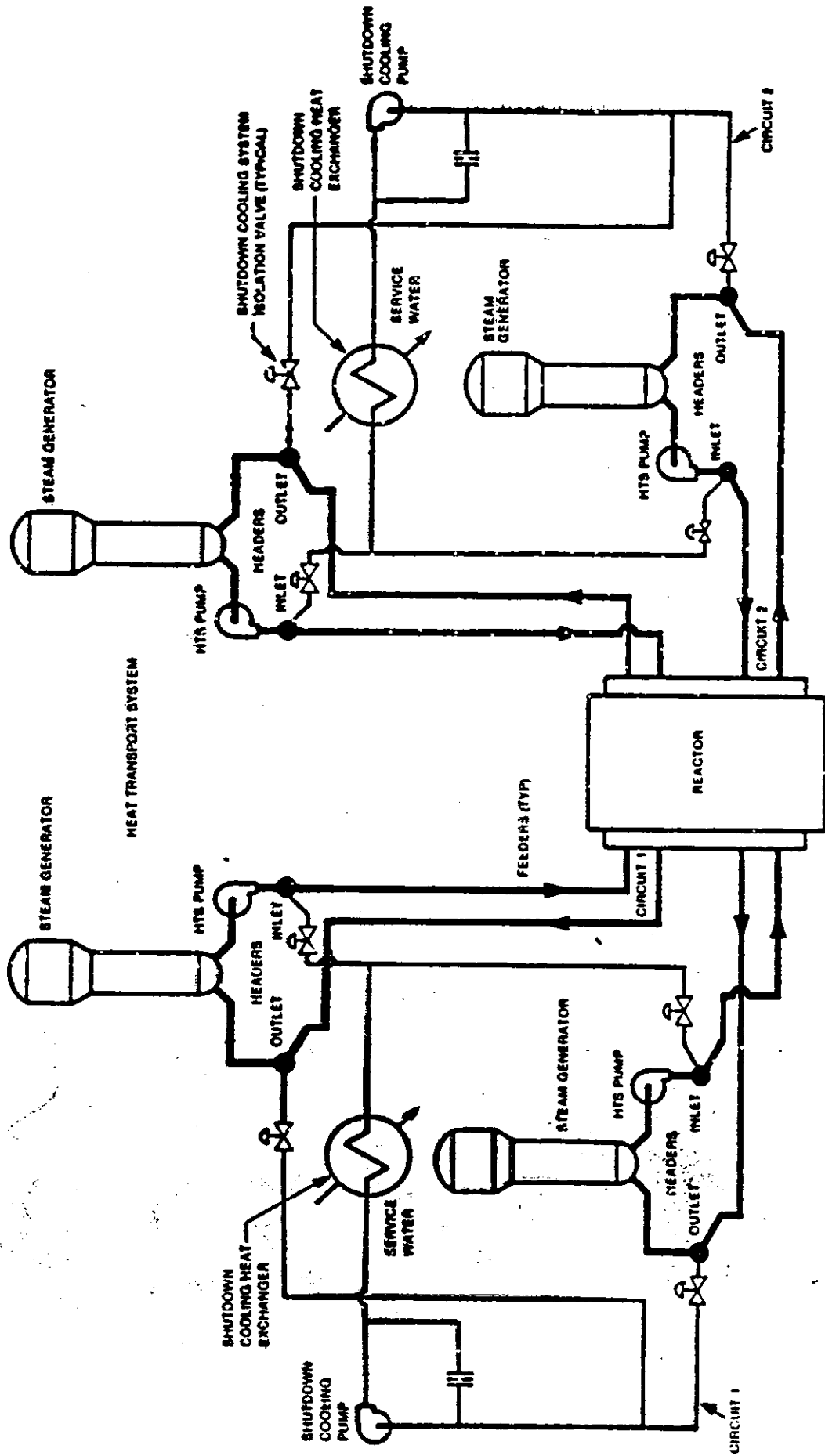

FIGURE 1.9 HEAT TRANSPORT PRESSURE AND INVENTORY CONTROL SYSTEM



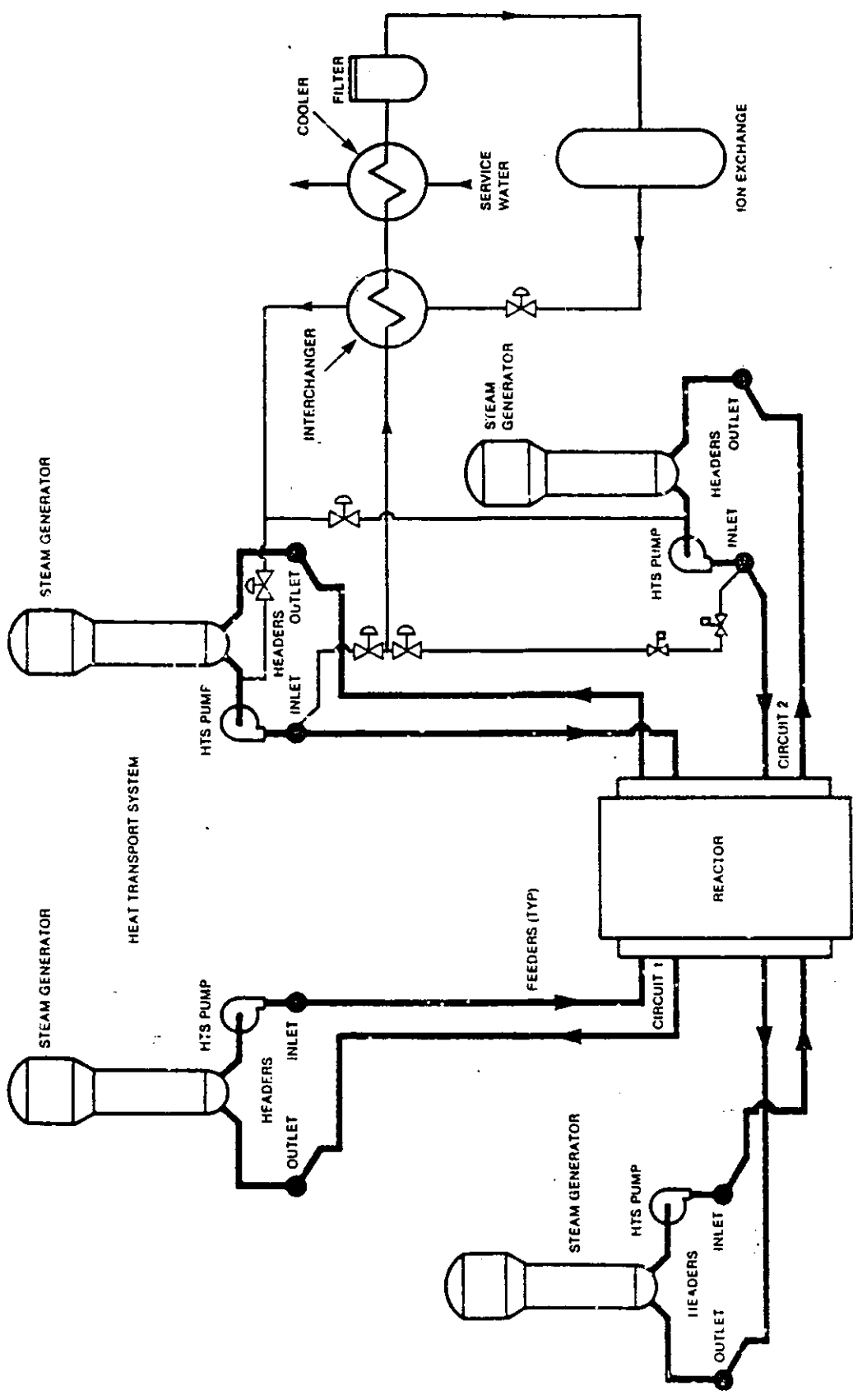

FIGURE 1.11 HEAT TRANSPORT PURIFICATION SYSTEM

SUMMARY OF SUGGESTIONS FOR EFFECTIVE COMPUTATION

1) KNOW YOUR SYSTEM

(FLOW IS MAJOR PARAMETER FOR H.T.S. T/H.)

2) COMPUTATION IS JUST PART OF A BIGGER JOB. PUT YOUR NEXT \$ WHERE IT WILL DO THE MOST GOOD.

(DON'T OVER OPTIMIZE)

(UTILIZE COMMON DATABASE)

3) MAKE FRIENDLY CODES

(COMPUTER ALGEBRA)

(ESTABLISH BASIC BUILDING BLOCKS)

(MICROS)

4) DO DETAILS AFTER BIG PICTURE IS IN PLACE.

(STABILITY PROBLEM, FOR EXAMPLE)

(OR VERIFICATION)

- END -



IN CONCLUSION

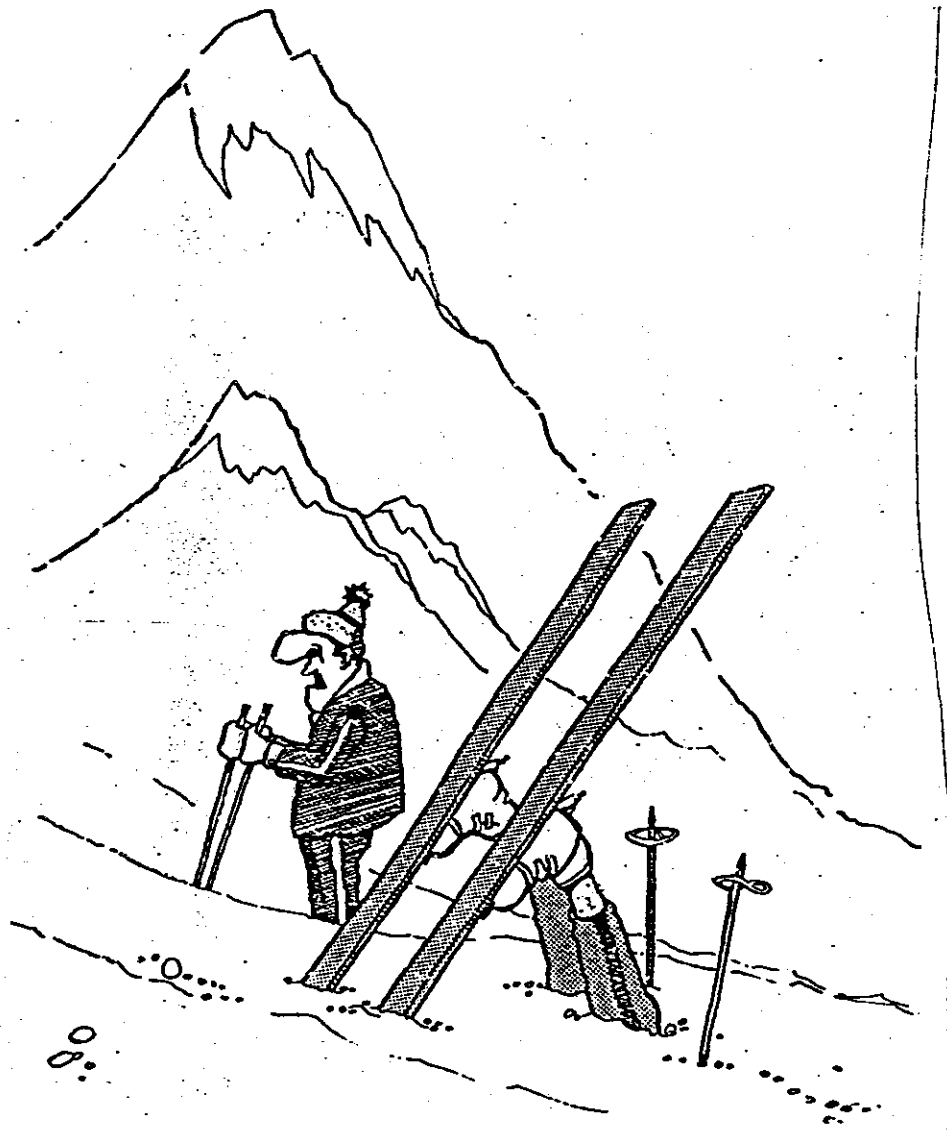

"Okay class...name four things he did wrong."