

CANADIAN POWER REACTOR FUEL

by
R.D. Page

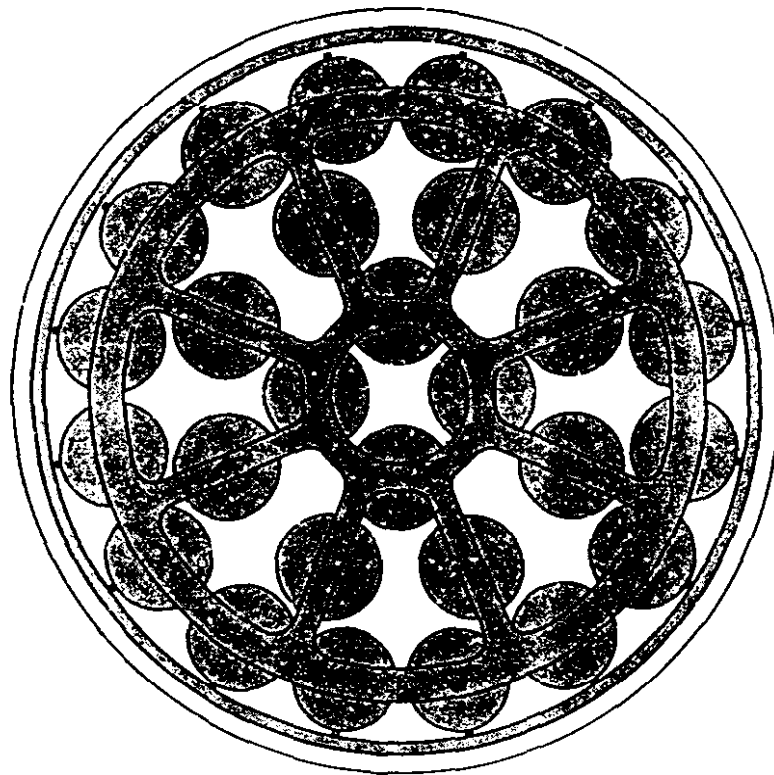

ATOMIC ENERGY OF CANADA LIMITED
Power Projects
Sheridan Park Research Community
Mississauga, Ontario, L5K 1B2
March 1976

AECL 5609

CANADIAN POWER REACTOR FUEL

by R.D. Page

ABSTRACT

This paper is intended to introduce the reader to Canada's power reactor fuel. It was originally written as part of a lecture series to introduce nuclear power to other utilities and customers not presently involved with the CANDU system. It has since been updated and presented in many forms. This recent revision brings it up to date to March 1976.

The paper covers the following broad subjects:

- a The basic CANDU fuel design.
- b The history of the bundle design
- c The significant differences between CANDU* and LWR⁺ fuel
- d Bundle manufacture
- e Fissile and structural materials and coolants used in the CANDU fuel program
- f Fuel and material behaviour, and performance under irradiation
- g Fuel physics and management
- h Booster rods and reactivity mechanisms
- i Fuel procurement, organization and industry
- j Fuel costs
- k Summary

* CANDU - *Canadian Deuterium Uranium Reactor*

+ LWR - *Light Water Reactor*

ATOMIC ENERGY OF CANADA LIMITED

Power Projects

Sheridan Park Research Community

Mississauga, Ontario, L5K 1B2

AECL 5609 March 1976

INDEX

Section	Page
1 Introduction	1
2 Fuel Design	1
3 Design and Development History	1
3.1 Pressurized Heavy Water Fuel - PHW	
3.2 Boiling Light Water Fuel - BLW	
3.3 Boiling Heavy Water - BHW	
3.4 Geometric Cross Sections	
4 Differences between CANDU and LWR	7
5 Fuel Manufacture	9
6 Fissile, Structural Materials and Coolants	18
6.1 Fissile Materials	
6.2 Structural Material	
6.3 Coolants	
7 Fuel Performance and Material Behaviour	20
7.1 Uranium Dioxide	
7.1.1 Thermal Conductivity	
7.1.2 Radiation-Induced Swelling	
7.1.3 Gas Release	
7.2 Zircaloy	
7.2.1 Irradiation or Fast Neutron Damage	
7.2.2 Corrosion and Hydrogen Pick-up	
7.2.3 Stress Corrosion Cracking	
7.3 Fuel Element	
7.3.1 Sheath Collapse	
7.3.2 Element Thermal Expansion	
7.3.3 Fission Gas Pressure	
7.3.4 Hydraulic and Fuelling Machine Loads	
7.4 Fuel Handling System	
7.5 Fuel Bundle Testing	
7.5.1 Out-reactor Tests	
7.5.2 Irradiation Testing	
7.5.3 Pressure and Temperature Cycles	
7.5.4 Power Cycles	
7.6 Fuel Bundle Performance	
7.6.1 Statistics of Fuel Bundle Performance	
7.6.2 Defect Mechanisms	
7.6.3 Fuel Performance Criterion	
7.7 Bundle and Element Behaviour Under Extreme Conditions	
7.7.1 Gross Overpower	
7.7.2 Dryout	
8 Fuel Physics and Management	42
8.1 Fuel Bundle and Core Flux Distributions	
8.2 Reactivity Mechanisms and Booster Rods	
9 Fuel Procurement	45
10 Fuel Industry	45
11 Fuel Costs	47
12 Potential for Future Development	52
13 Summary	52

Figure No.	TITLE	Page
1	Fuel Bundle for Pickering Reactor Assembled from Seven Basic Components	2
2a	Bruce 37-Element Bundle	3
2b	600 MWe 37-Element Gentilly-2 Fuel Bundle	3
3	<i>Fuel Bundle Cross Sections</i>	5
4a	Fuels for Canada's Power Reactors 8 cm Bundles NPD, Douglas Point	6
4b	Fuels for Canada's Power Reactors, 10 cm Bundles, Pickering, Gentilly-1, Bruce and Gentilly-2	6
5	Natural Uranium Cycle	8
6	Enriched Uranium Cycle	8
7	NPD and Douglas Point Wire Wrap Spacing and Bundle Construction	9
8	Cross Section through Closure Weld	9
9	Cross Section of Bundle Assembly Weld	10
10	Split Spacer Design	10
11	Close-up of Brazed Split Spacer and Bearing Pad	11
12	Cross Section of Brazed Spacer	11
13	Pictorial Process Steps in the Natural Uranium Fuel Cycle	12
14	Split Spacer Bundle Manufacturing Steps	13
15	UO ₂ Production	14
16	Fuel Bundle Production Stage 1	15
17	Fuel Bundle Production Stage 2	16
18	Fuel Bundle Assembly	17
19	Typical Transverse Cross Section of Irradiated UO ₂ at Four Power Ratings showing Pellet Cracks and UO ₂ Grain Growth	21
20	Percent Fission Gas Release versus UO ₂ Power Rating	22
21	Influence of Cold Work as represented by the Axial Ultimate Tensile Strength on Circumferential Elongation in the Closed-End Burst Test	22
22	Effect of Oxygen on the In-reactor Corrosion of Zircaloy, 270-300°C	23
23	Deuterium Pickup of NPD Sheathing	24
24	Cross Section of Fuel Element showing Zr Hydride Damage	24
25	Stress Corrosion Cracking	25
26a	Pellet Interface Circumferential Strains Measured with <i>Resistance Strain Gauges during the First Power Cycle</i> (two different tests) compared with Calculated Expansions	26
26b	Mid Plane Circumferential Strains, ditto	26
27	Fuel Sheath Interactions	27
28	Pickering Fuel Handling System	29
29	Bruce Fuel Handling System	30
30	600 MWe Reactor Fuel Handling System	31
31	Pickering Fuelling Machine	31
32	<i>Douglas Point Fuelling Machine</i>	32
33	Example of Douglas Point Defect	35
34	Defect Mechanisms	36
35	Stress Corrosion Cracking Model	37

Figure No.	TITLE	Page
36	Fuelograms	38
37	Cross Section of Element and Centre Melting in UO ₂	39
38	Thermal and Hydraulic Regimes in Vertical Upward Flow	40
39	Sheath Temperature versus Time to Defect	41
40	High Temperature Corrosion Failure of Fuel Element	41
41	Douglas Point Axial Flux Profile	42
42	Pickering Axial Flux Profile	43
43	Bundle Radial and Axial Flux Distribution	44
44	Gentilly Booster Cross Section	45
45	Bruce Booster Fuel String Assembly	46
46	Fuel Supply Organization	47
47	CANDU Fuel Production and Irradiation Data (to March 1976)	48
48	Projected Annual CANDU Uranium Consumption	49
49	CANDU Projected Zircaloy Requirements	50
50	Variation of Bundle Power and Fuel Costs showing Evolution with Time	50
51	Uranium Concentrate Price versus Year of Delivery or Contract	51

Table No.

I	Canadian Power Reactor Fuel Design and Operating Data	5
II	Differences between CANDU and LWR Fuel	7
III	Fissile, Structural Materials and Coolants	18
IV	Composition of Zircaloy-2 and 4	19
V	AECL Loop Data	33
VI	CANDU Fuel Performance (March 1976)	34

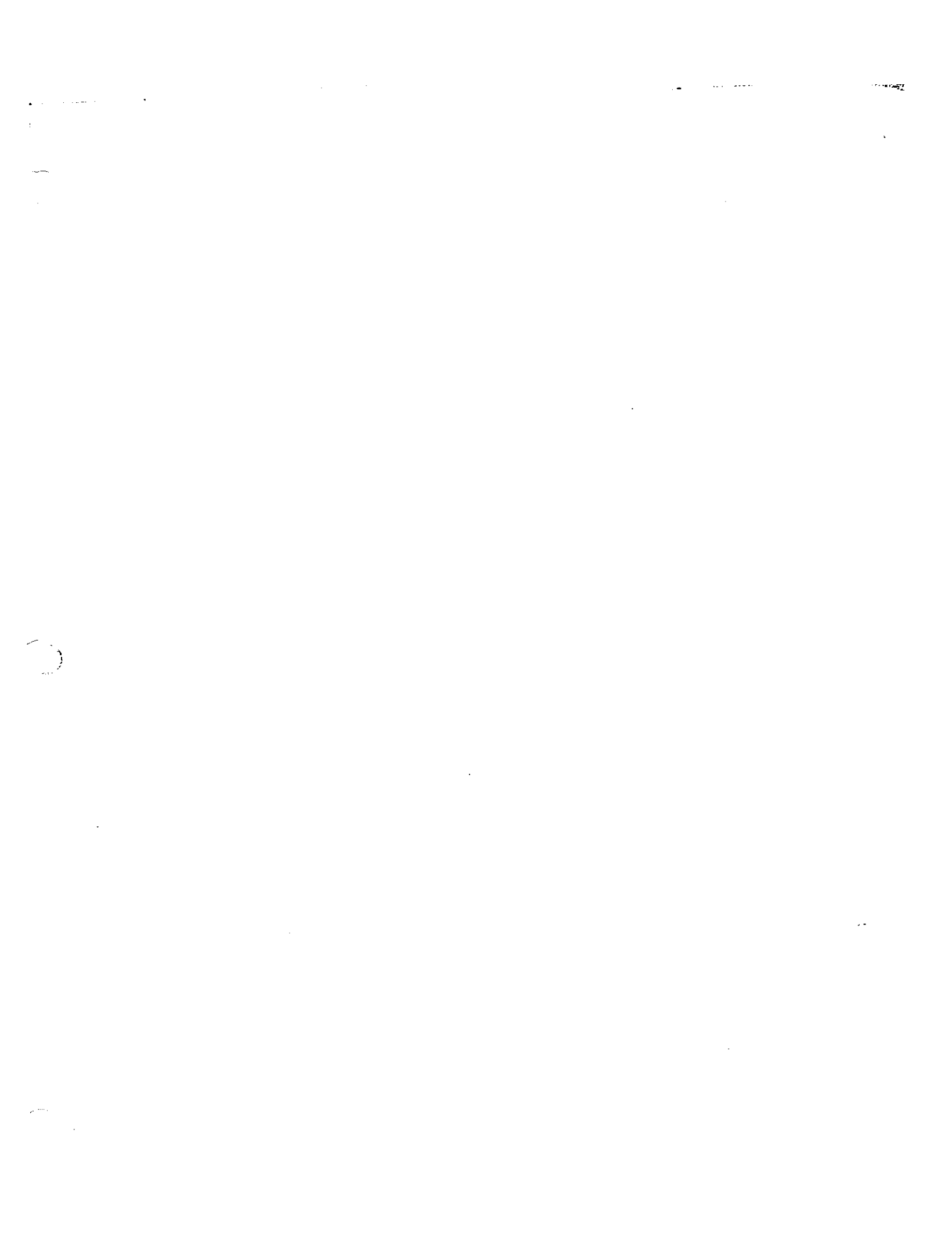

1 INTRODUCTION

1

In Canada the development of power-reactor fuels began approximately twenty years ago with the design and manufacture of the first charge for the demonstration power reactor, NPD*. Early successes are attributed to a deliberate policy of cooperation between Atomic Energy of Canada Limited and private industry. In subsequent years, as the designs were improved and more fuel was manufactured, both the AECL laboratories and private industry grew in maturity. A division of responsibility evolved whereby manufacturing and design know-how became entrusted to private industry, while the AECL laboratories concentrated on fundamental studies related to more advanced applications. At the same time fuel management techniques were developed by the Hydro-Electric Power Commission of Ontario⁺, the principal customer for nuclear fuel in Canada. Thus, through long-term planning and investment in people and facilities, Canada has built a strong integrated capability for research, development, manufacturing and use of nuclear fuel.

From the beginning, the objective has been to develop power-reactor fuels that are reliable and inexpensive, and have low parasitic absorption. To achieve this objective, the fuel has been kept as simple as possible. The bundle consists of only the fuel material and a *minimum containment envelope*; all related but non-consumable components — such as channels, orifices, control and monitoring equipment, and fuel-handling hardware — are kept as part of the reactor capital equipment. Fabrication techniques are also simple and, whenever possible, are adapted from normal industrial practice. These techniques are susceptible to standardization and automation, and the number of different processes is minimized.

2 FUEL DESIGN

The Pickering bundle shown in Figure 1 is typical of the fuel designers' response to the objectives. It is a bundle of 28 closely packed elements, each containing high-density natural UO₂ in a thin (0.4 mm) Zircaloy sheath (ref. para. 6.2). Plates welded to the end of the elements hold them together; spacers brazed to the sheaths keep the desired separations. The bundle is approximately 50 cm long and 10 cm in diameter.

The Pickering fuel bundle is 92 wt% UO₂; the 8 wt% Zircaloy is made up of the sheaths, end-caps, structural end-plates, and spacers. The structural material accounts for only 0.7% of the thermal neutron cross section of the bundles, to give a fuel assembly that is highly efficient in its use of neutrons. There are only seven different types of components in the 76,000 bundles produced to date for the 2,160 MW(e) gross Pickering Generating Station. Replacement Pickering fuel is identical to the original charge except for the addition of Canlab (para 7.6.2).

3 DESIGN AND DEVELOPMENT HISTORY

3.1 Pressurized Heavy Water Fuel — PHW

The design and development of fuel for the CANDU type reactors have been well documented (References 1 through 9): therefore it is only necessary to outline briefly the salient points.

* NPD — Nuclear Power Demonstration

+ "Ontario Hydro" is an electrical utility with 7,270 MW(e) of CANDU reactors (moderated and cooled with heavy water) in operation and under construction.

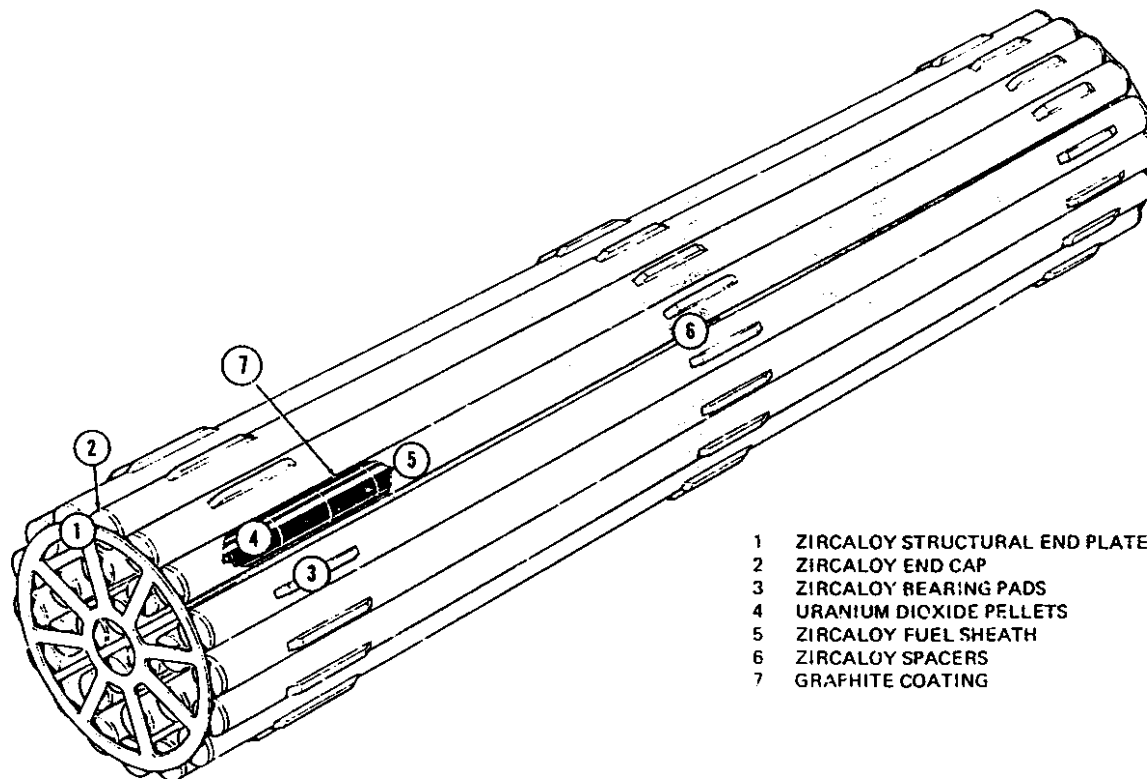

FIGURE 1 Fuel Bundle for Pickering Reactor, Assembled from Seven Basic Components

The original fuel charge for NPD contained wire-wrapped 7-element bundles in the outer zone and 19-element wire wrap bundles in the centre (ref. para. 5). The 7-element bundle has not been developed further and is being phased out of the reactor. The 19-element bundle design was modified for Douglas Point by changing the wire wrap to a tighter pitch and rearranging the wire wrap array for better mixing. Also wire bearing pads were added to protect the pressure tube and bundle from wear during on-power fuelling. Because of the concern of possible sheath fretting by the wire wrap which spaces the elements apart, the replacement fuel for this reactor utilizes a brazed skewed split spacer design (ref. para. 5) The fuel for the Pickering reactors as described previously uses the same length and diameter of element (495 mm and 15.3 mm) and method of fabrication, but the number of elements has been increased to 28 to fill the 10 cm diameter pressure tube, as shown in Figure 1, compared to the 8 cm diameter pressure tube for NPD and Douglas Point.

For the 750 MWe Bruce reactors a 37-element bundle has been developed using the same construction methods with minor changes in design with respect to bearing pad position and end cap profile (see figure 2a). These changes were introduced because of the different channel design, different fuelling machine and handling systems for Bruce, compared with Pickering. This 37-element design is also proposed for future Bruce reactors and for the 1250 MWe reactor which is under development.

A similar 37-element bundle to that of Bruce is being developed for the standard 600 MW(e) reactor now under construction at Gentilly for Hydro Quebec, Lepreau for the New Brunswick Electric Power Commission, Cordoba for Argentina and Wolsung for Korea, (figure 2b). This bundle is nearly identical to the 28-element Pickering bundle except for

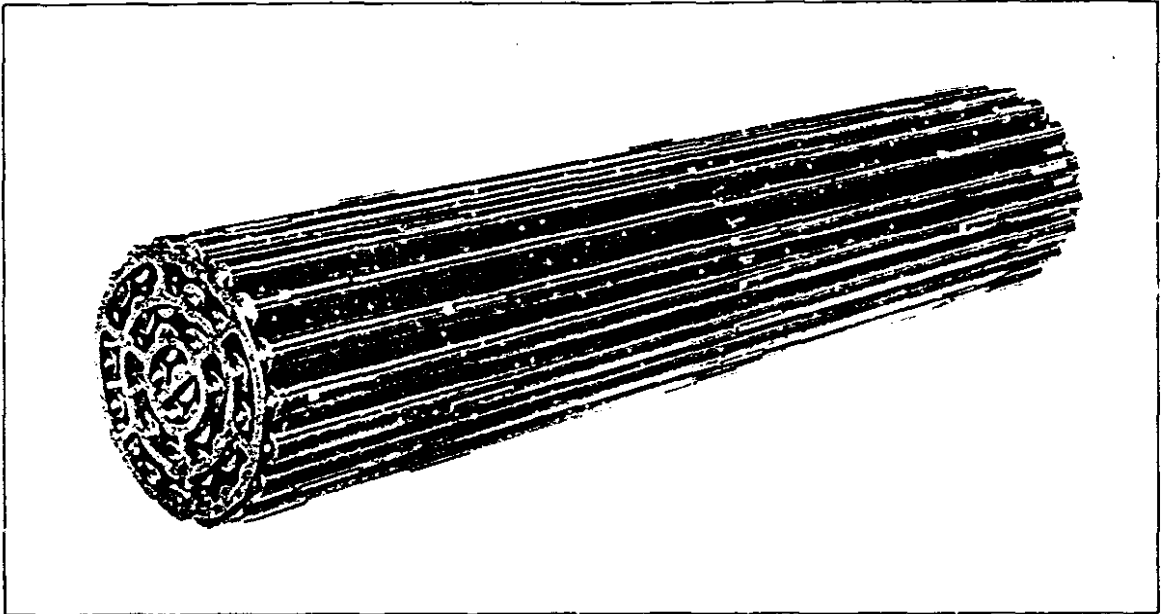

FIGURE 2a Bruce 37-Element Bundle

the fact that it has 37-elements instead of 28. The reason for the similarity is that the 600 MWe reactor has a channel and fuelling machine similar to that of Pickering.

3.2 Boiling Light Water Fuel – BLW

The basic design philosophy for the BLW fuel for Gentilly has used, where possible, the technology that has already been developed in the PHW program. However, a number of departures from PHW practice have been necessitated by the particular requirements of the BLW type of reactor. (6)

The most significant of these modifications – a change in both element and bundle design – is due in large part to the fact that, in a boiling reactor, the maximum heat flux on the

FIGURE 2b 600 MWe Gentilly-2 37-Element Fuel Bundle

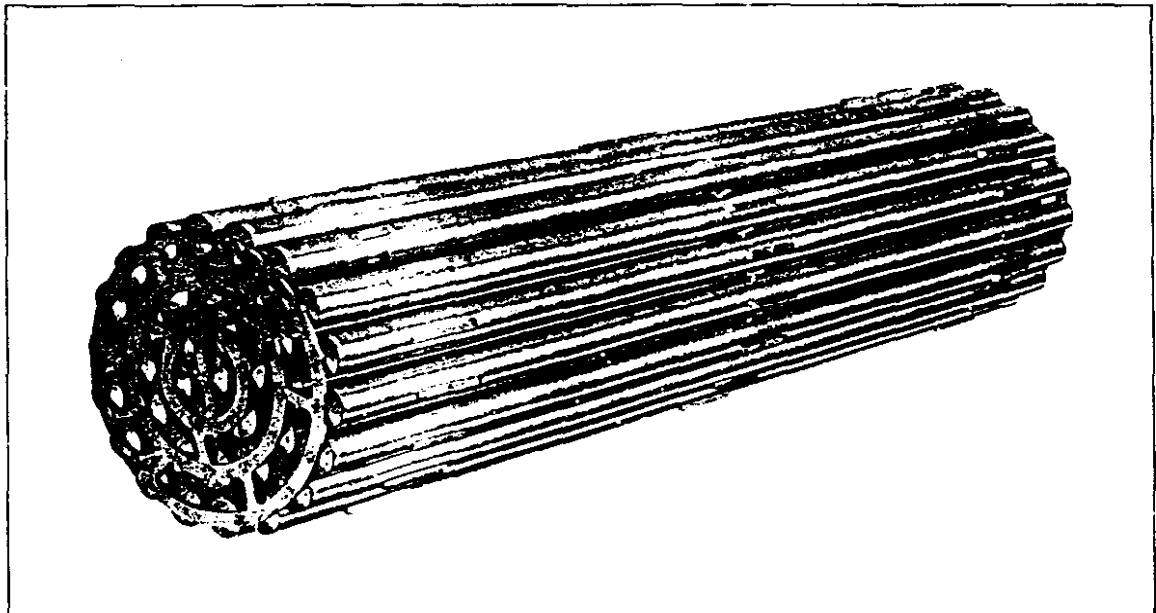

4 fuel is limited by dryout*. Another important factor in this change, is the requirement for BLW reactors to keep the amount of light water in the reactor core to a minimum by means of boiling to high qualities and of limiting the coolant flow area within a bundle. Although the Gentilly reactor is based on a 10 cm channel diameter, it was felt that the above requirements could best be met by a 19-element radially pitched bundle, rather than the 28-element 10 cm diameter bundle already under development for the Pickering reactor. The specific reasons for this choice were:

- 1) The better general understanding of the thermal and hydraulic performance of the 19-element geometry.
- 2) The greater amount of critical heat flux data available for the 19-element geometry.
- 3) The smaller coolant cross-sectional area in a 19-element geometry than in a 28.

In the case of the design selected, the coolant cross-sectional area was reduced even further by the use of a 1 mm inter-element spacing, rather than the 1.27 mm used to date in the PHW program.

A second major change from PHW practice resulted from the need in the Gentilly reactor to have all the fuel bundles of a channel connected together, to permit on-power refuelling from the bottom end of the reactor. To satisfy this requirement, the central element is removed from the basic 19-element configuration and this central vacant site is then used for a structural member which holds the bundles together in a string. This structural member is in the form of a gas-filled tube with a spring at its lower end, which applies a compressive load to the bundles in the string, thus preventing relative rotational movement.

3.3 Boiling Heavy Water — BHW

The original reactors such as NPD, Douglas Point and Pickering were true PHW reactors with under-saturated coolant conditions at the exit from the channels. However, Bruce and post-Bruce and the 600 MWe reactors have some degrees of boiling at channel exit. Bruce is better defined as a saturated reactor because some channels will be boiling and others not. The combined effect in the feeders is a saturated condition. The 600 MW(e) and 1250 MW(e) reactors will have all channels delivering some net steam quality into the feeders.

3.4 Geometric Cross sections

The various cross sections of the bundles mentioned in Sections 3.1, 3.2 and 3.3 are shown in Figure 3. The design and operating conditions are listed in Table 1, and examples of the bundles are shown in Figures 4a and 4b.

* Dryout (or critical condition) may be defined as the breakdown of the water film on the surface of a heated fuel element. This breakdown is accompanied by a sudden decrease in the local heat transfer coefficient, and a resultant sharp increase in sheath temperature. (ref. para. 7.7.2)

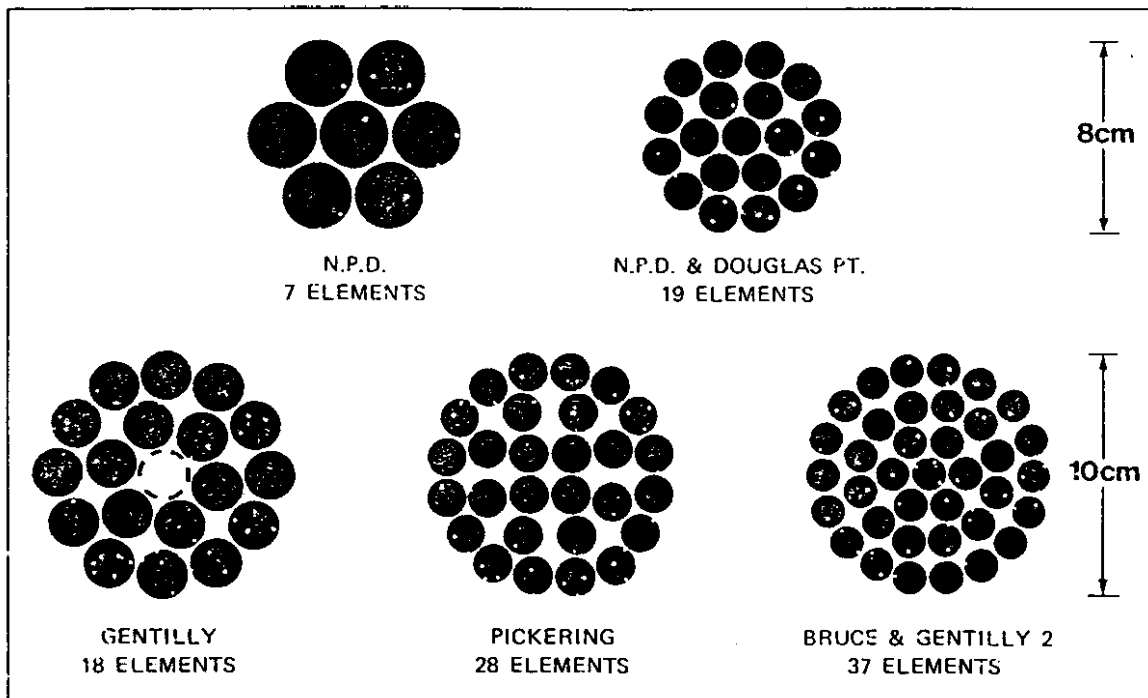
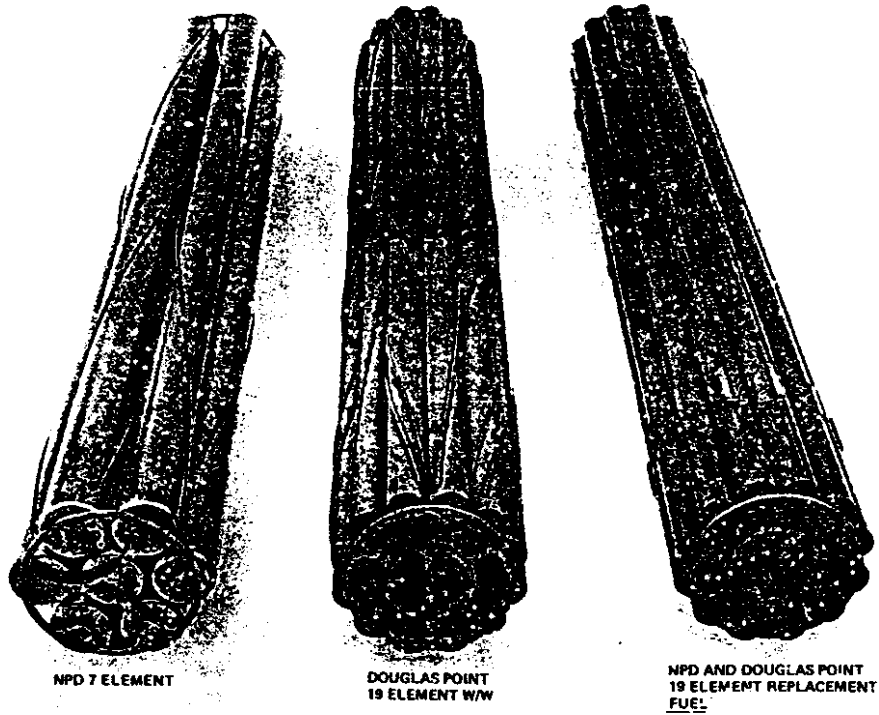

FIGURE 3 Fuel Bundle Cross Sections

TABLE I Canadian Power Reactor Fuel Design and Operating Data

REACTOR		NPD	NPD	DOUGLAS POINT	GENTILLY 1 BLW	PICKERING A	BRUCE A	600 MW
NUMBER OF ELEMENTS PER BUNDLE		7	19	19	18	28	37	37
ELEMENTS								
MATERIAL		ZIRC-2	ZIRC-4	ZIRC-4	ZIRC-4	ZIRC-4	ZIRC-4	ZIRC-4
OUTSIDE DIAMETER	mm	25.4	15.25	15.22	19.74	15.19	13.08	13.08
MIN. CLADDING THICKNESS	mm	0.64	0.38	0.38	0.49	0.38	0.38	0.38
BUNDLES								
LENGTH	mm	495.3	495.3	495.3	500.0	495.3	495.3	495.3
MAXIMUM DIAMETER	mm	82.04	82.04	81.74	102.41	102.49	102.49	102.49
NUMBER PER CHANNEL		9	9	12	10	12	13	12
PRESSURE TUBE								
MINIMUM INSIDE DIAMETER	mm	82.55	82.55	82.55	103.56	103.38	103.38	103.38
OPERATING CONDITIONS								
COOLANT		D ₂ O	D ₂ O	D ₂ O	H ₂ O	D ₂ O	D ₂ O	D ₂ O
NOMINAL INLET PRESSURE	MPa	7.9	7.9	10.16	6.32	9.6	10.2	11.09
NOM. CHANNEL POWER	MW	0.985	0.985	2.752	3.15	5.43	6.5	6.5
EXIT STEAM QUALITY	%	—	—	—	16.5	—	0.8/4.0	~2.55
MAX. MASS FLOW/CHANNEL	kg/sec	6.6	6.6	12.6	11.2	23.88	23.81	23.94
NOM. HEAT RATING $\int \lambda dl$	kW/m	3.45	2.08	4.0	4.8	4.2	4.55	4.0
MAXIMUM LINEAR ELEMENT POWER	kW/m	43.4	24.9	50.3	61.2	52.8	57.23	50.9
MAX. SURFACE HEAT FLUX	kW/m ²	560.7	514.1	1070.	986.5	1120.	1393.	1237.
NOM. BUNDLE POWER	kW	221.	221.	420.	484.	636.	900.	800.
AVG. DISCHARGE BUNDLE BURNUP	MWh/kgU	156.	156.	190.	168.	170/185	196.	180.



NPD 7 ELEMENT

DOUGLAS POINT
19 ELEMENT W/W

NPD AND DOUGLAS POINT
19 ELEMENT REPLACEMENT
FUEL

FIGURE 4a Fuels for Canada's Power Reactor, 8 cm Bundles, NPD, Douglas Point

FIGURE 4b Fuels for Canada's Power Reactors, 10 cm Bundles, Pickering, Gentilly-1, Bruce and Gentilly-2

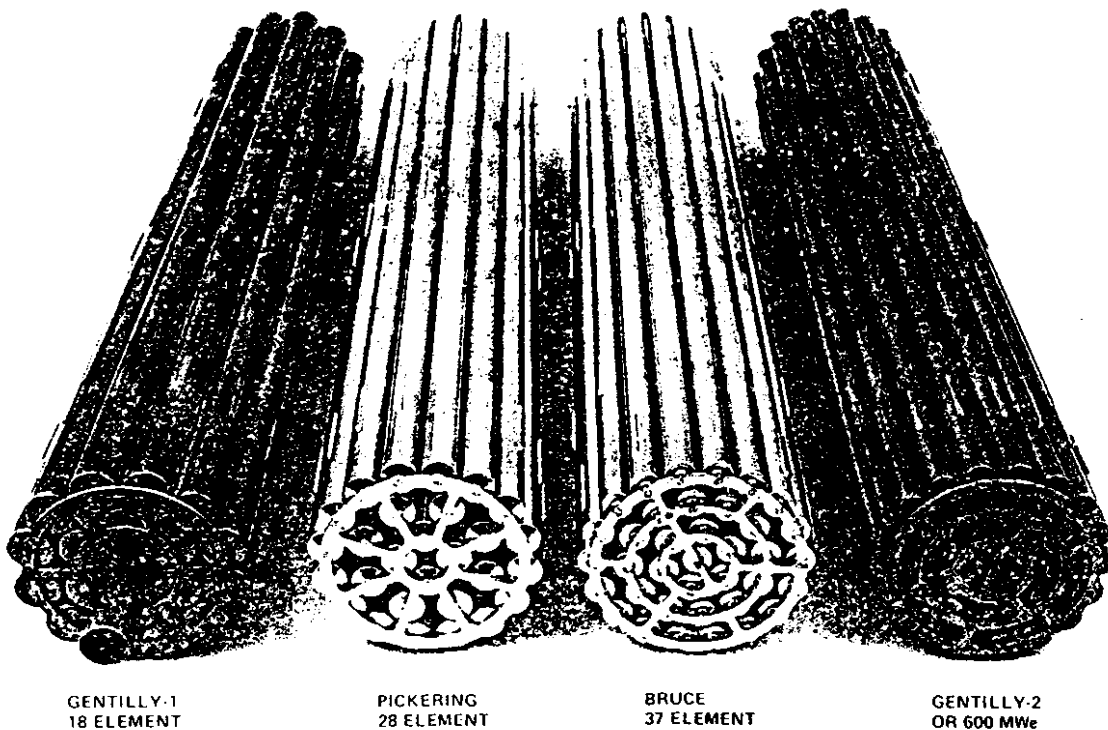

GENTILLY-1
18 ELEMENT

PICKERING
28 ELEMENT

BRUCE
37 ELEMENT

GENTILLY-2
OR 600 MWe

4 DIFFERENCES BETWEEN CANDU AND LWR

The significant differences between CANDU PHW fuel and that used in the LWR American enriched reactors are listed in Table II.

	CANDU PHW	LWR	RATIO $\frac{\text{LWR}}{\text{PHW}}$
Fissile Materials	Natural U 0.7% U235	Enriched 1.5 - 3%	3
Total Fuel Cost	Low	High	3 to 4
Length (Element)	Short	Long	8
Diameter (Element)	Larger	Smaller	0.7
Sheath Thickness	Thin	Thick	1.45
Diametral Gap	Low	High	2.3
Complexity	Simple	Complex	-
UO ₂ Density	High	Medium	0.98
Spacing (Element)	Small	Large	2.7
Fuelling	On power	Off power	-

TABLE II Differences between CANDU and LWR Fuel

The significance of these differences in fuel design is difficult to summarize briefly without going into a detailed comparison between the two reactor systems and their fuel cycles - PHW versus LWR. However, the following can be stated — enriched fuels are more expensive by a factor of 10 in total fuel costs, resulting in a fuelling cost 2.5 times greater, when allowances are made for the higher burnup of the LWR.

The major reason for this large difference in costs is the use of enrichment in the LWR reactor fuel cycle. The enriched uranium requires a number of added steps in the manufacturing flow sheet. Schematics of the natural and enriched uranium cycles are shown in Figures 5 and 6.

The enriched fuel cycle relies on spent fuel reprocessing to recover the unused fissile uranium, and plutonium, which are credited to the fuel cycle costs.

Even comparing the fabrication costs of the bundles only, the PHW fuel is approximately one-third the price of LWR fuel.

It should be noted that because LWR fuel is full length, the whole assembly has to be discharged, if any part becomes defective. It is possible, with the short PHW fuel bundle and on-power fuelling, to reject only a small part of the defective fuel in the channel.

The simple CANDU natural uranium cycle contributes only a small amount to the cost of power e.g., approximately 1.0 mills/kWh (1976) for Pickering reactors.

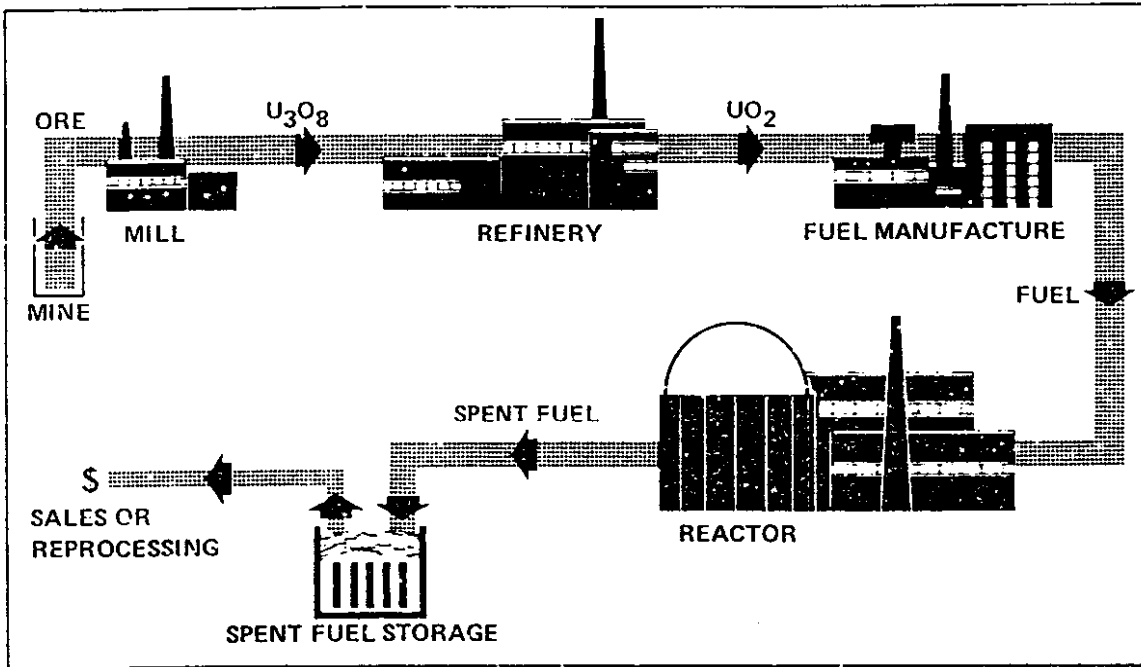
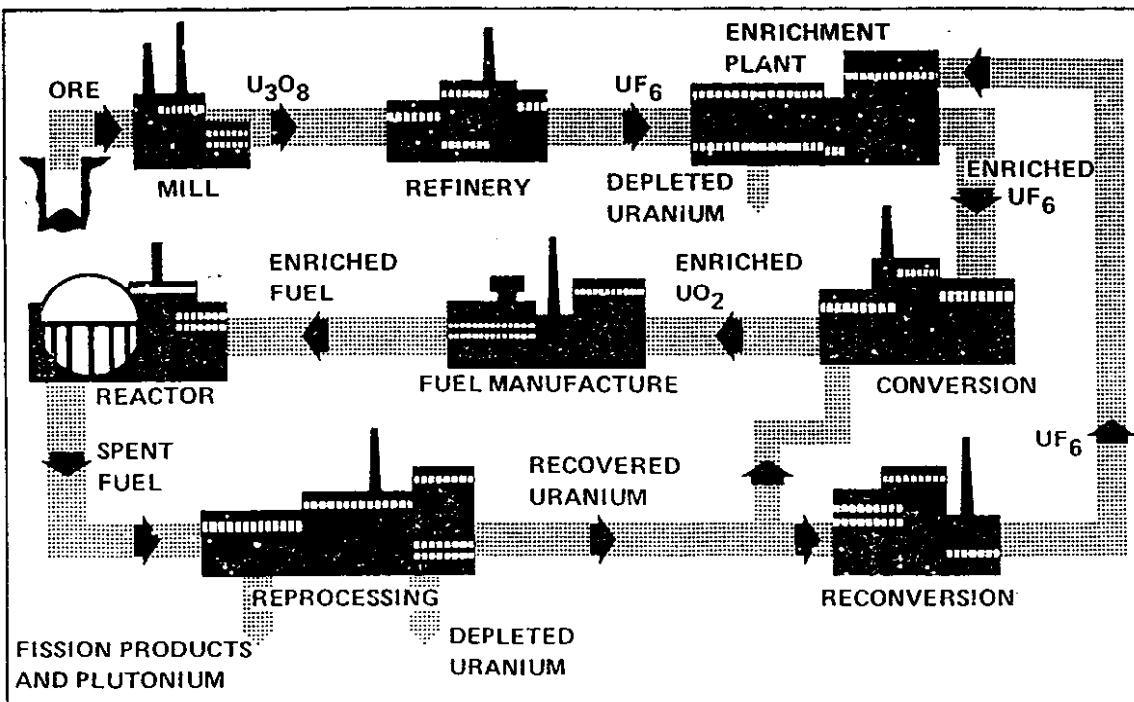

FIGURE 5 Natural Uranium Cycle

FIGURE 6 Enriched Uranium Cycle



5 FUEL MANUFACTURE

9

The original fuel designs for NPD were wire wrapped bundles of both 7 and 19-elements.

The wire wrap which spaced the elements from each other and the pressure tube was spot welded to the sheath, Figure 7. The elements were sealed and assembled by tungsten inert gas (T.I.G.) welding, which is a slow process and one which is difficult to control consistently on an automatic basis.

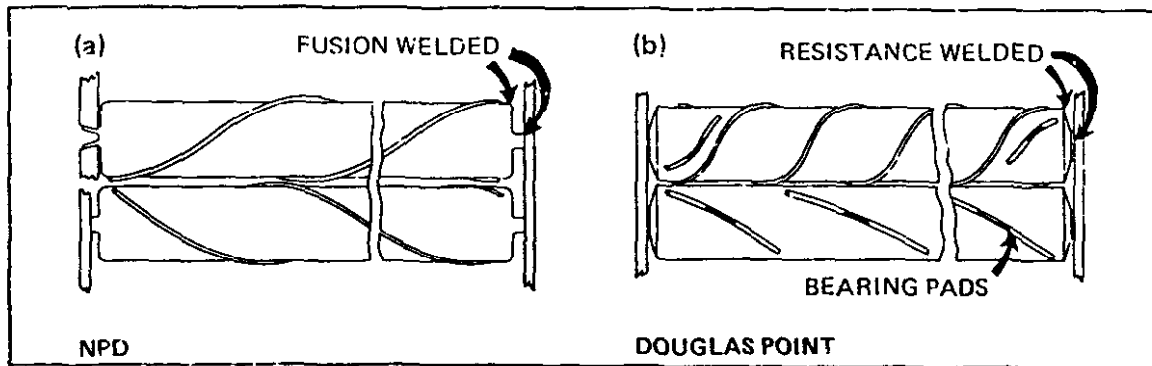
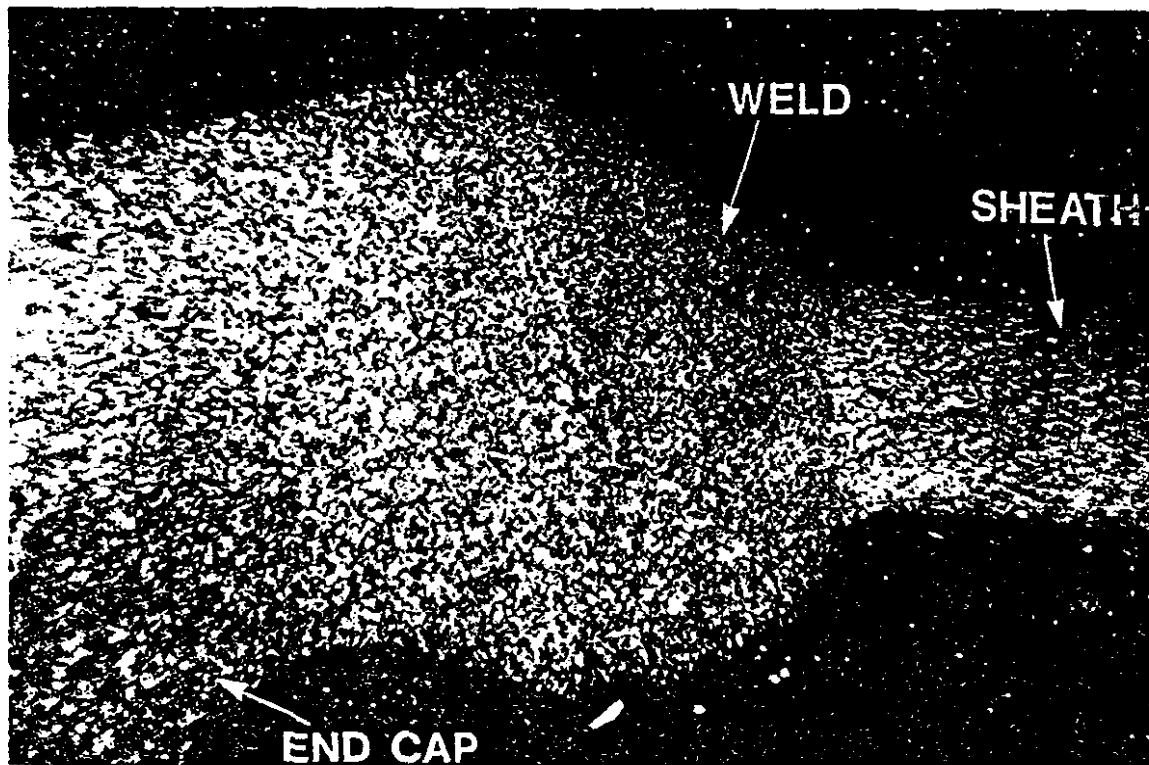

FIGURE 7 NPD and Douglas Point Wire Wrap Spacing and Bundle Construction

For the Douglas Point bundle, we developed resistance welding for both the end cap to sheath and the end plate to end cap joint, Figure 7(b). This method of welding is fast, cheap and can be controlled consistently, lending itself to automation. Cross sections of the joints are shown in Figures 8 and 9.

FIGURE 8 Cross Section through Closure Weld



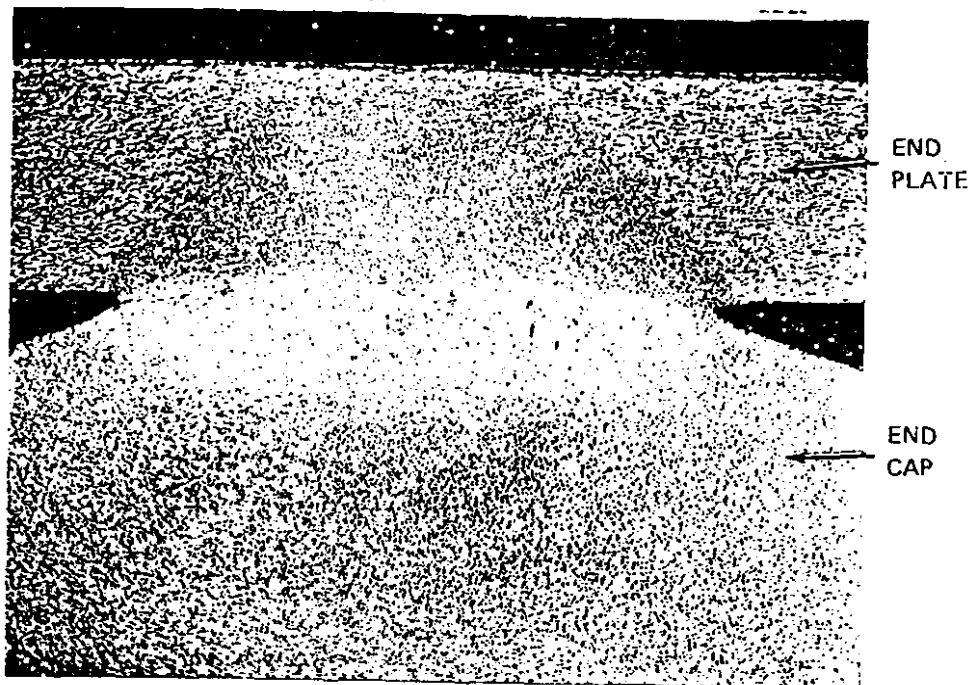
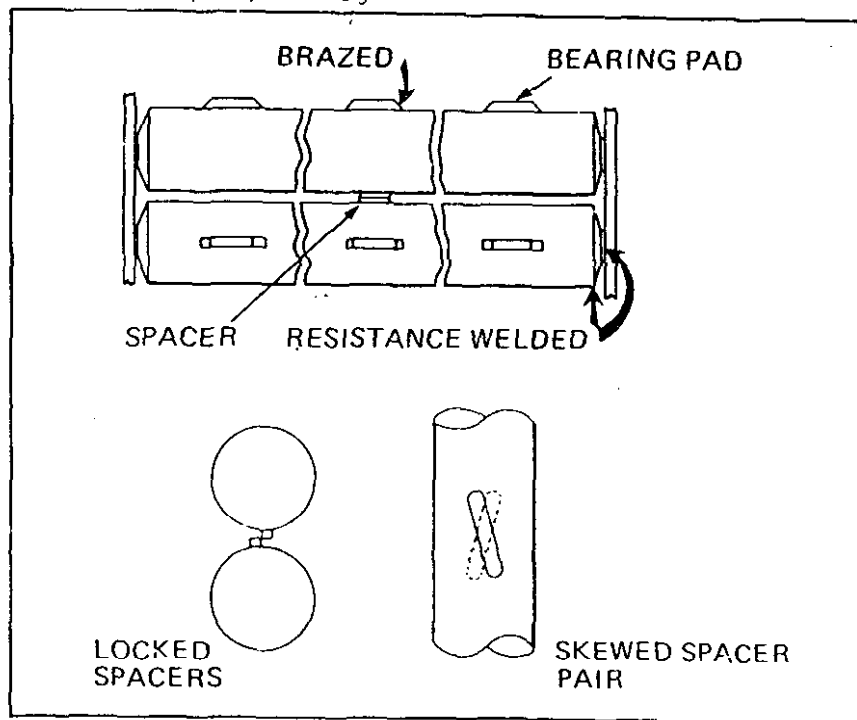

FIGURE 9 Cross Section of Bundle Assembly Weld

The brazed split spacer was developed as an alternative to the wire wrap spacer. It is constructed by induction heating the tube and spacer to 1060°C in vacuum to allow the Zr-Be alloy braze to flow. The spacers were skewed to prevent interlocking as shown in Figure 10. A close up of the spacer and bearing pad is shown in Figure 11, with a cross-section of a brazed spacer in Figure 12.

FIGURE 10 Split Spacer Design



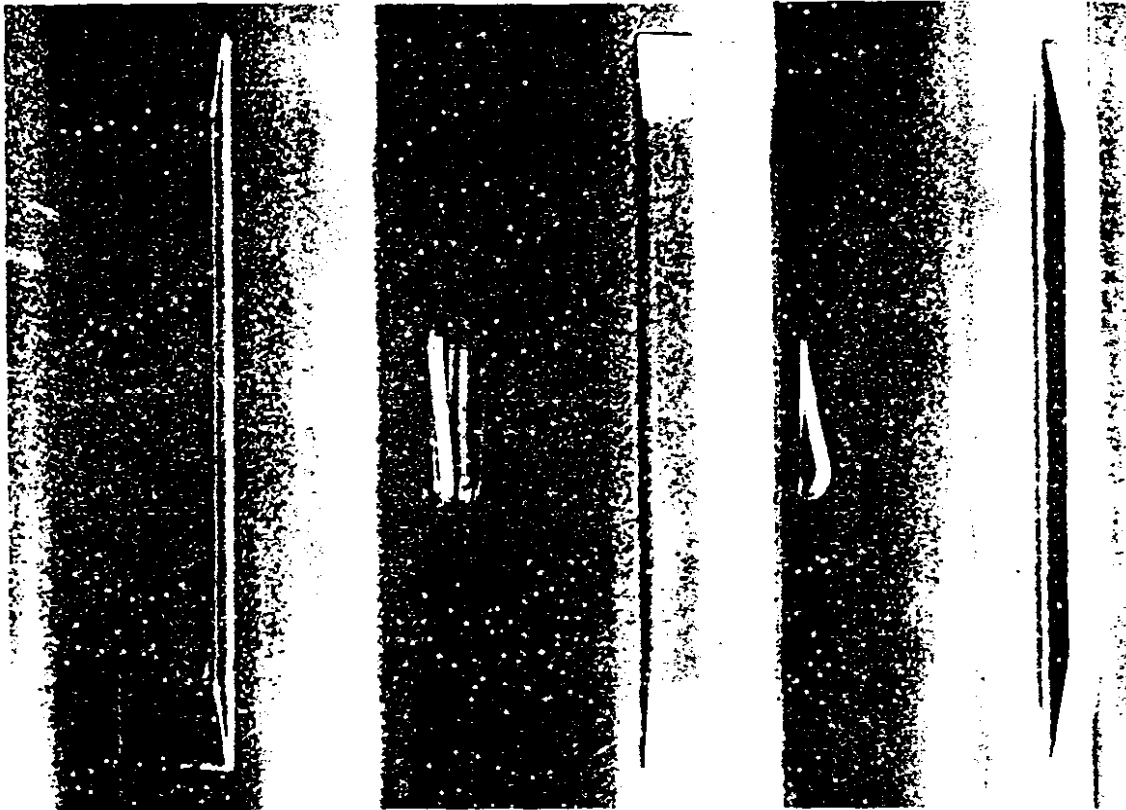
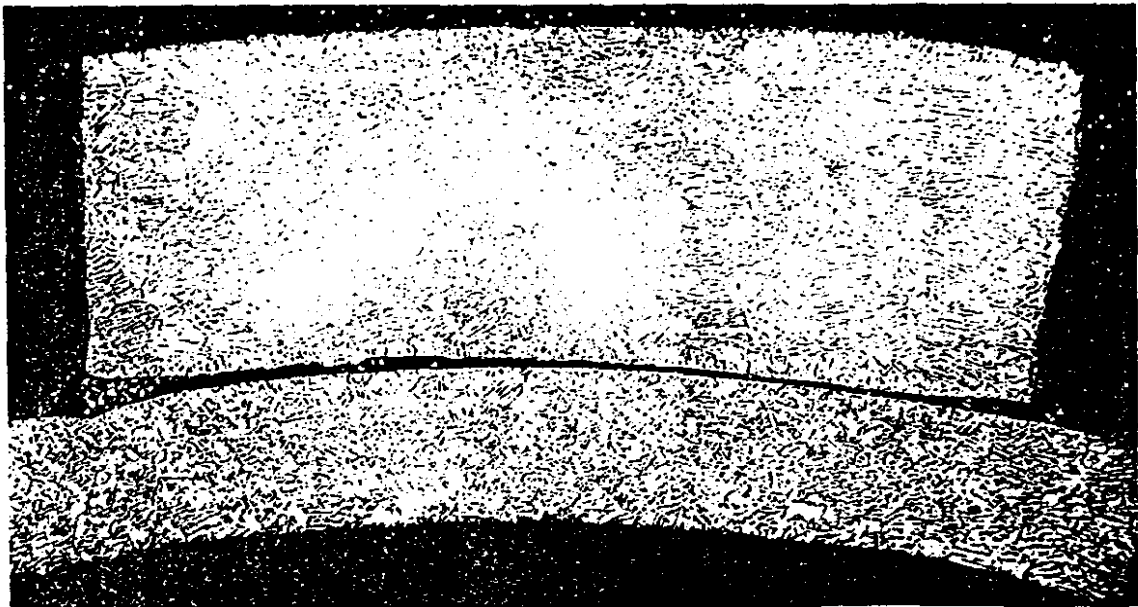

FIGURE 11 Close-up of Brazed Split Spacer and Bearing Pad

The fuel cycle and the various steps in the production of a fuel bundle are shown in Figures 13 and 14 and outlined pictorially in Figures 15, 16, 17 and 18.

Canadian fuel relies heavily on detailed quality control at every step in production, and the overall quality control program is audited by the utilities inspectors on a continuing basis (Ref. 10).

FIGURE 12 Cross Section of Brazed Spacer



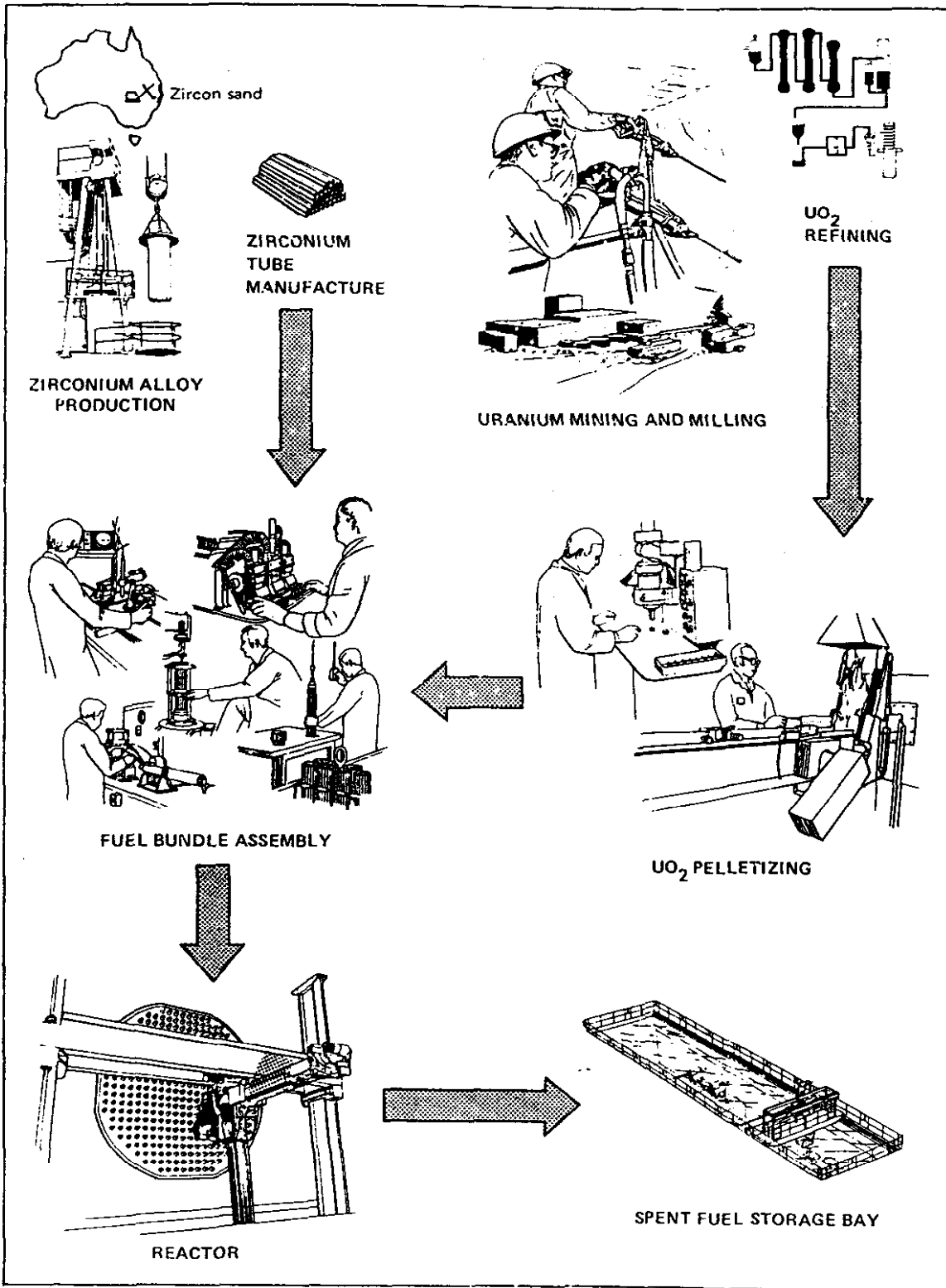

FIGURE 13 Pictorial Process Steps in the Natural Uranium Fuel Cycle

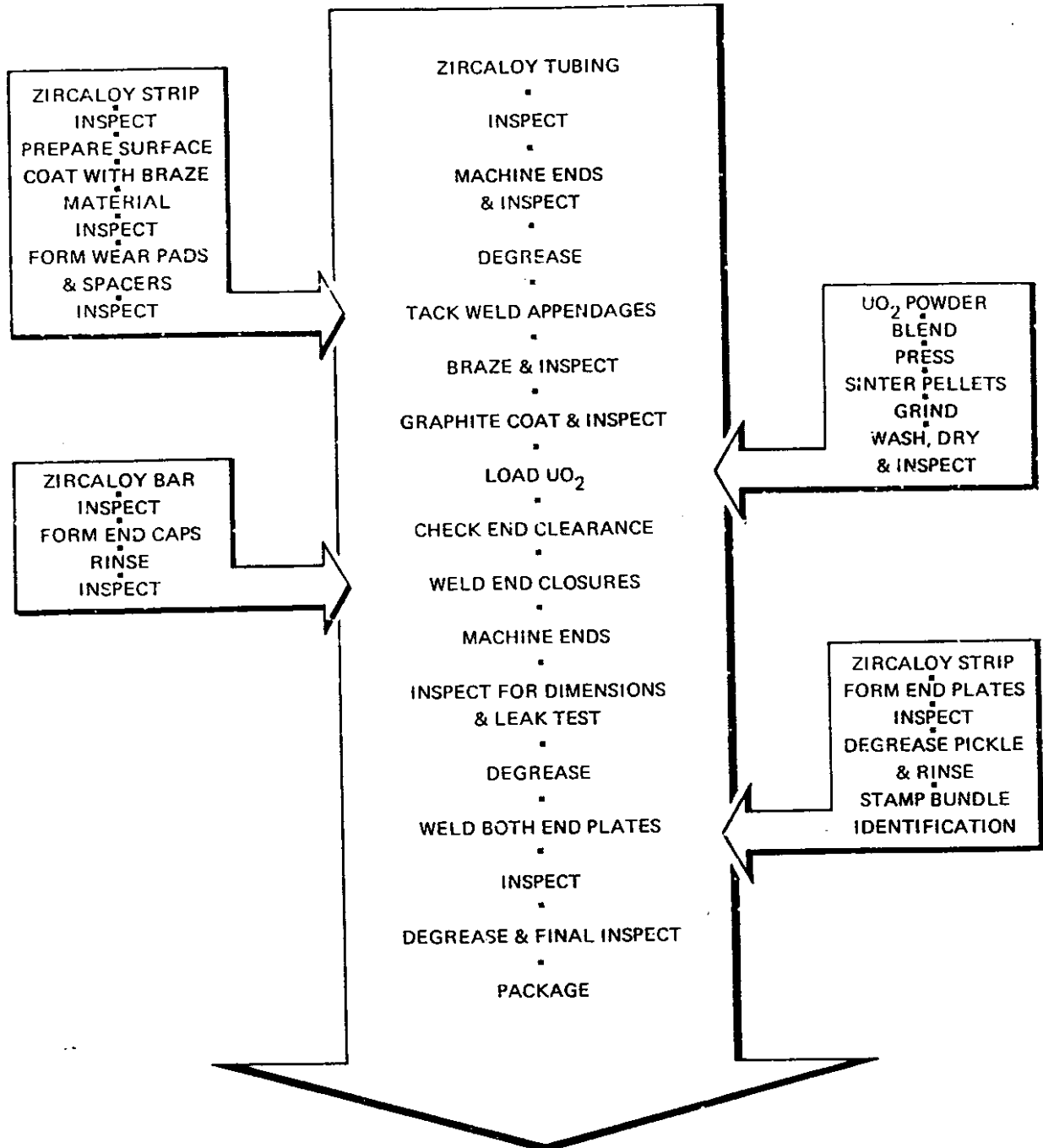

FIGURE 14 Split Spacer Bundle Manufacturing Steps

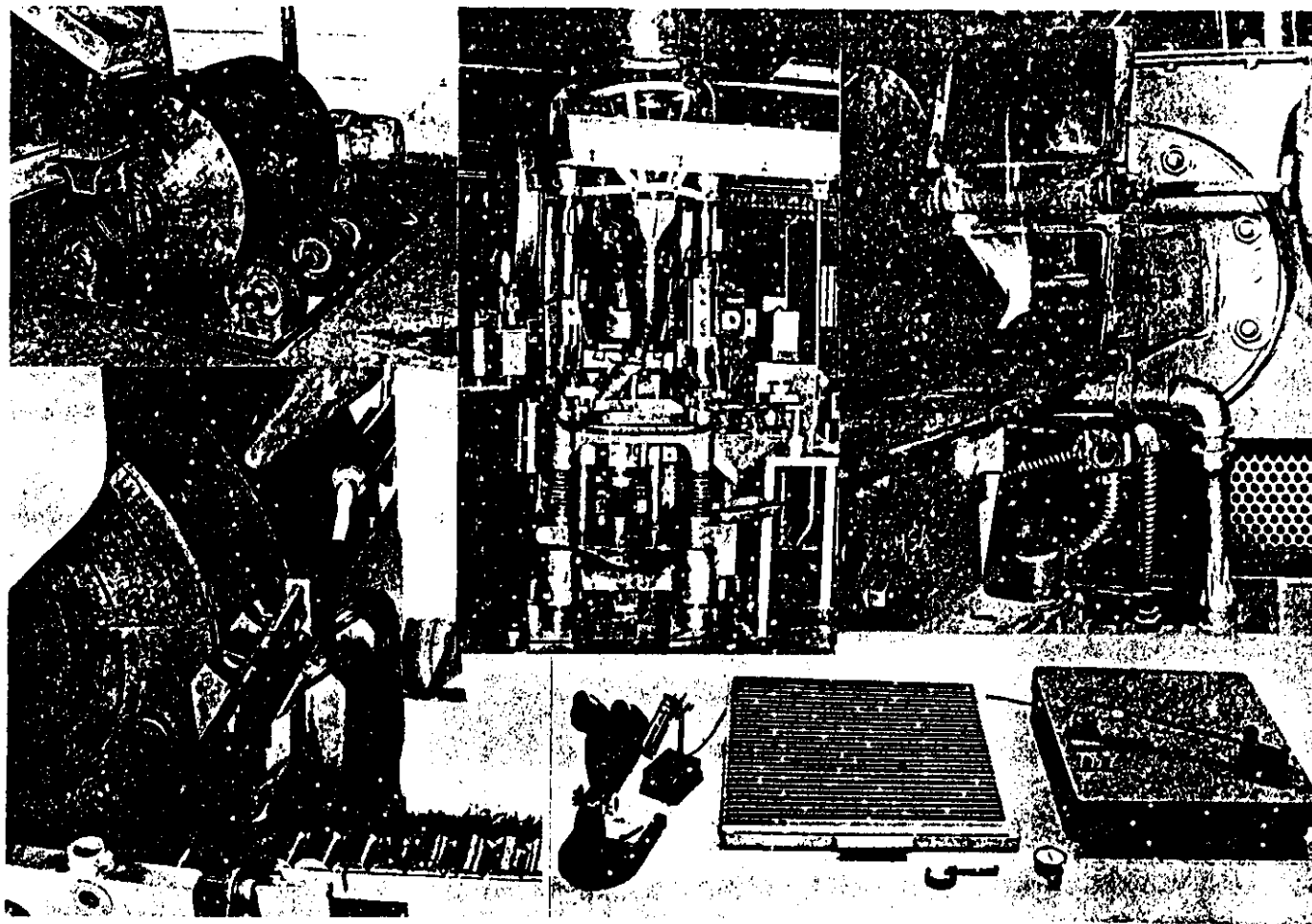
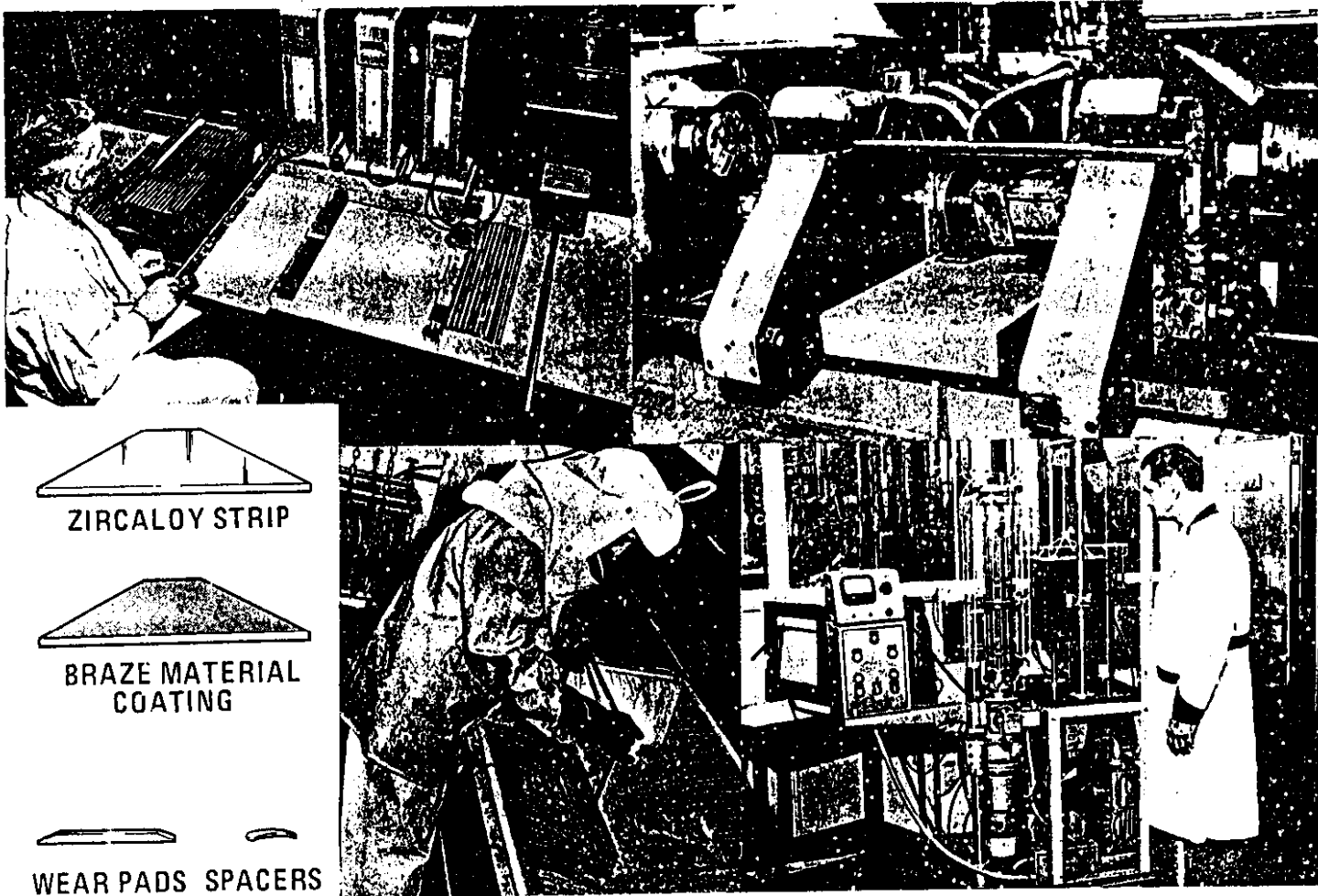

FIGURE 15 UO₂ Production



ZIRCALOY STRIP



BRAZE MATERIAL COATING



WEAR PADS SPACERS

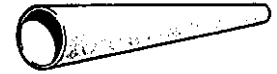

ZIRCALOY TUBES



MEASURING AND FLAW INSPECTION

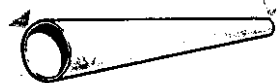

END MACHINING

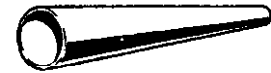

DEGREASING



APPENDAGE BRAZING AND INSPECTION

FIGURE 16 Fuel Bundle Production Stage 1

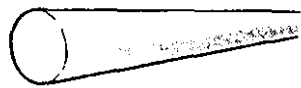

ZIRCALOY BAR



END CAP FORMING,
CHECK



DEGREASING,
PICKLING, RINSING

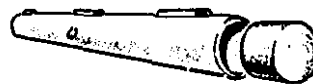
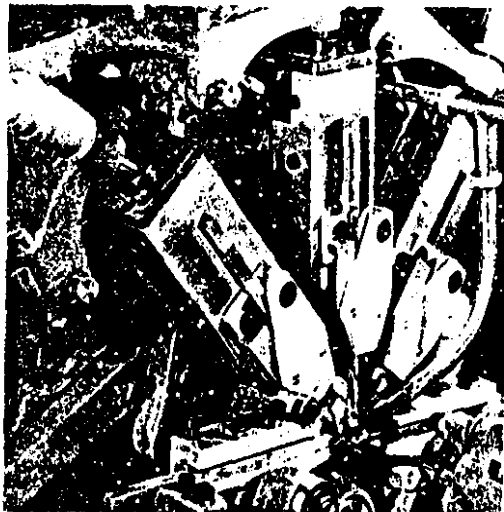

UO₂ LOADING



UO₂



END CLOSURE
WELDING



END MACHINING

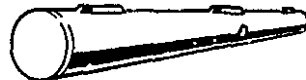

DEGREASING

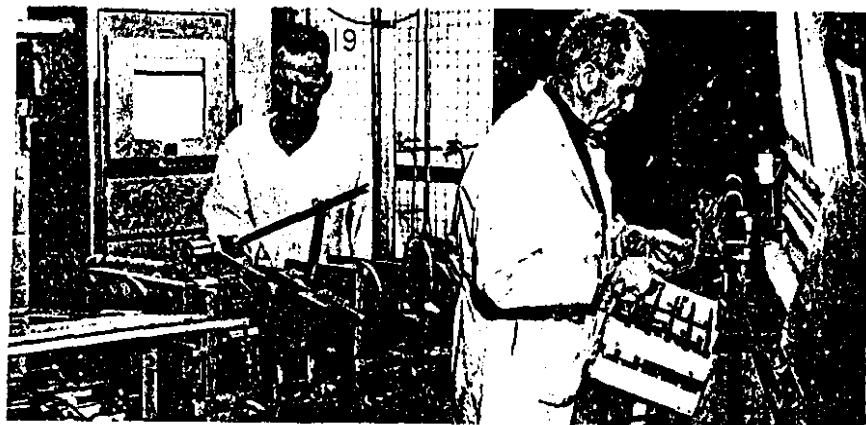
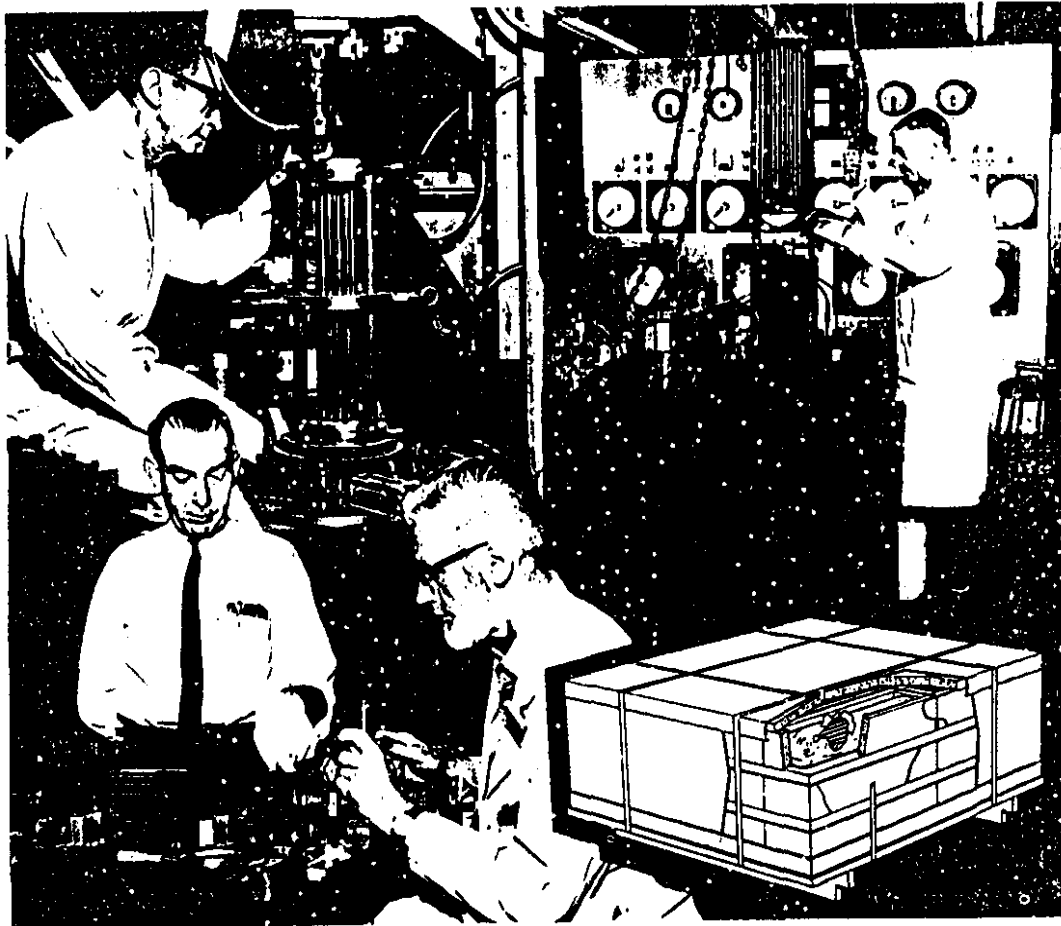
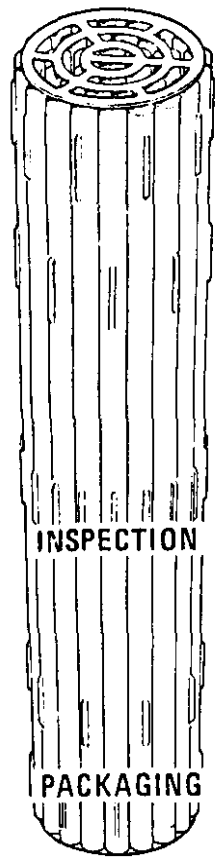
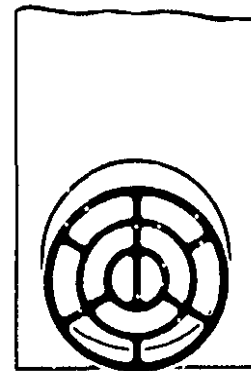

FIGURE 17 Fuel Bundle Production Stage 2

END PLATE WELDING



ZIRCALOY STRIP



END PLATE FORMING

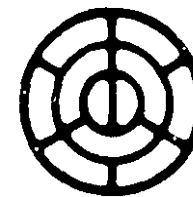

DEGREASING, PICKLING
& RINSING

FIGURE 18 Fuel Bundle Assembly

6 FISSILE, STRUCTURAL MATERIALS AND COOLANTS

The various fissile, structural materials and coolants that are being used or developed for Canada's power reactor program are listed in Table III.

FISSILE MATERIAL	STRUCTURAL MATERIALS	COOLANTS	REACTORS
<u>TEST REACTORS</u>			
U, UO ₂ , U-Al	Al	H ₂ O	NRX
U, U-Al	Al	D ₂ O	NRU
UO ₂ , UC	Zr-2½ wt % Nb	Organic	WR-1
<u>POWER REACTORS</u>			
UO ₂	Zircaloy-2 and 4	D ₂ O-Liquid D ₂ O-Boiling H ₂ O-Boiling	PHW BHW BLW
<u>BOOSTER RODS FOR POWER REACTORS</u>			
U-Al	Al	D ₂ O	Gentilly
U-Zr	Zircaloy	D ₂ O	NPD, Douglas Point & Bruce
<u>MATERIALS IN DEVELOPMENT</u>			
UC	Zr-1 wt % Nb	D ₂ O- H ₂ O-Boiling and Organic	Future Reactors
PuO ₂ -UO ₂			
ThO ₂ -UO ₂			

TABLE III Fissile, Structural Materials and Coolants

6.1 Fissile Materials

Uranium metal was the original fuel for NRX and NRU research reactors. The fuel was formed into full length round rods or flat plates, clad in aluminum. The reactors at present are fuelled with enriched uranium-aluminum alloy fuel, clad in aluminum. This type of fuel allows the reactors to operate at higher neutron fluxes, at lower powers and operating costs.

Uranium metal has poor dimensional stability under irradiation and very poor corrosion resistance in the high temperature water necessary to produce power. Satisfactory behaviour of UO₂ for organic-cooled reactors has been demonstrated; the less corrosive coolant allows the use of uranium carbide (UC) with its higher uranium density. For water-cooled power reactors the corrosion rates of UC are far too high, and the only presently acceptable fuel is UO₂.

The fuel material for the bundles can be selected to accommodate a changing economic situation. It is expected that plutonium recycling will be economically attractive before the end of the next decade (11) and that thorium-based (33) fuels will be used later. Fabrication and irradiation of UO₂ - PuO₂ and ThO₂ - UO₂ have revealed no unexpected difficulties, and demonstration bundles of UO₂-PuO₂ are in the NPD reactor. They have reached a burnup of 500 MWh/kgU and further irradiations are planned for Douglas Point.

6.2 Structural Material

The basic structural material used in the construction of fuel assemblies is Zircaloy-2 or -4. These are alloys of zirconium originally developed by the Americans for their naval reactor program to give low thermal neutron cross section and good corrosion resistance in 300°C water.

Table IV indicates the alloying elements of Zircaloy-2 and -4.

	Zircaloy-2	Zircaloy-4
Tin	1.20 - 1.70 wt%	1.20 - 1.70 wt%
Iron	0.07 - 0.20 wt%	0.18 - 0.24 wt%
Chromium	0.05 - 0.15 wt%	0.07 - 0.13 wt%
Nickel	0.03 - 0.08 wt%	—
Total Fe + Cr + Ni	0.18 - 0.38 wt%	0.26 - 0.37 wt%
Carbon	80 - 300 ppm	80 - 300 ppm
Oxygen	900 - 1600 ppm	900 - 1600 ppm
Zr + Permitted Impurities	Balance	Balance

TABLE IV Composition of Zircaloy-2 and 4

The only differences between Zircaloy-2 and Zircaloy-4, are the deletion of nickel and the slight increase in iron in Zircaloy-4. Their behaviour as fuel sheathing is similar.

All Canadian power reactor fuels in production today use Zircaloy-4. It has a slight corrosion and hydrogen pick-up performance advantage over Zircaloy-2 under our coolant conditions.

6.3 Coolants

The predominant coolant in Canada's program has been pressurized heavy water (PHW) and is used in NPD, Douglas Point, Pickering and Bruce. Boiling heavy water (BHW) was also used in NPD for two years as an experiment.

The outer zone of the Bruce core has low net exit quality 3% and future reactors will have increasing qualities at exit from the channel, as the power density is increased with a constant inlet coolant temperature.

The Gentilly reactor uses normal light water as a coolant and the reactor is designed to boil the water in the reactor (BLW). The average exit quality for the core is 16.5 wt% steam.

Because organic coolants can be operated at higher temperatures than water while at lower pressures, they are being developed for future reactors. WR-1 test reactor at WNRE*, Manitoba, is cooled by this fluid (HB-40). This higher temperature of the coolant will allow higher overall station thermal efficiency. A comparable station would discharge about a third less heat through its condenser than a PHW per unit of energy generated. Due to

* Whiteshell Nuclear Research Establishment

AECL's limited resources in manpower and materials it has been decided not to develop the organic reactor at the present time. However, it may come into commercial application in the late 1990's when it becomes necessary to develop a more efficient system with higher steam temperatures.

Liquid metals and molten salt coolants were investigated for a short time for future use, but these studies have been discontinued.

7 FUEL PERFORMANCE AND MATERIAL

7.1 Uranium Dioxide

7.1.1 Thermal Conductivity

UO₂ is a ceramic and has a low thermal conductivity, relative to metal fuels. The thermal conductivity varies with temperature. When operating in a reactor at power, the UO₂ has a high centre temperature with respect to its surface temperature. The centre temperature is dependent on both the diameter of the element and the power rating. The term $\int_{\theta_s}^{\theta_c} \lambda d\theta$ is often used as a reference of UO₂ ratings* and represents the integrated thermal conductivity of the UO₂ from the temperature at the surface to the centre of the pellet.

Due to the low strength of the UO₂ in tension, the pellets crack when they are subjected to a neutron flux because of the large thermal gradient which occurs. At temperatures of 800-1400°C, UO₂ becomes plastic and will creep and flow into voidage provided to accommodate the volumetric thermal expansion. Above approximately 1400°C grain growth begins to occur. Examples are shown in Figure 19 with the extent of grain growth increasing with rating or equivalent centre temperatures.

7.1.2 Radiation-Induced Swelling

It has been found that under certain conditions, the swelling rate of irradiated UO₂ at relatively low temperatures is 0.7% change in volume per 10²⁰ fission/cm³ (2% per 10,000 MWd/TeU). Of this, perhaps half is due to solid fission products and the remainder due to the formation of gas-filled bubbles within the fuel. At high power outputs, however, a significant volume of the fuel is so hot that it retains very little gas. At intermediate temperatures (800-1400°C) fuel plasticity and gas mobility are appreciable, while gas release is low, which might cause the swelling rate to reach a maximum.

Swelling can be accommodated in porosity in the fuel. Below about 1400°C, porosity is probably not greatly reduced by fuel thermal expansion, so may still be available to accommodate swelling. Since current production fuels are less than 97% dense, there should be no problems with swelling up to burnup of 240 MWh/kgU (10,000 MWd/TeU). In practice, during the latter part of its lifetime, Canadian power reactor fuel operates at a power output lower than its previous maximum and the shrinkage cracks that are formed are available to accommodate some further swelling. For these reasons we do not envisage any swelling limitations with fuel elements made from natural UO₂.

* For round rods the power per unit length is given by $\frac{4\pi}{f_1} \int_{\theta_s}^{\theta_c} \lambda d\theta$ where $f_1 = 1$ for solid rods with uniform power density.

Therefore $\int_{\theta_s}^{\theta_c} \lambda d\theta = \frac{q}{4\pi} f_1$ where θ_s is the temperature at surface of the UO₂ and θ_c is temperature of the UO₂ at the centre. (12)

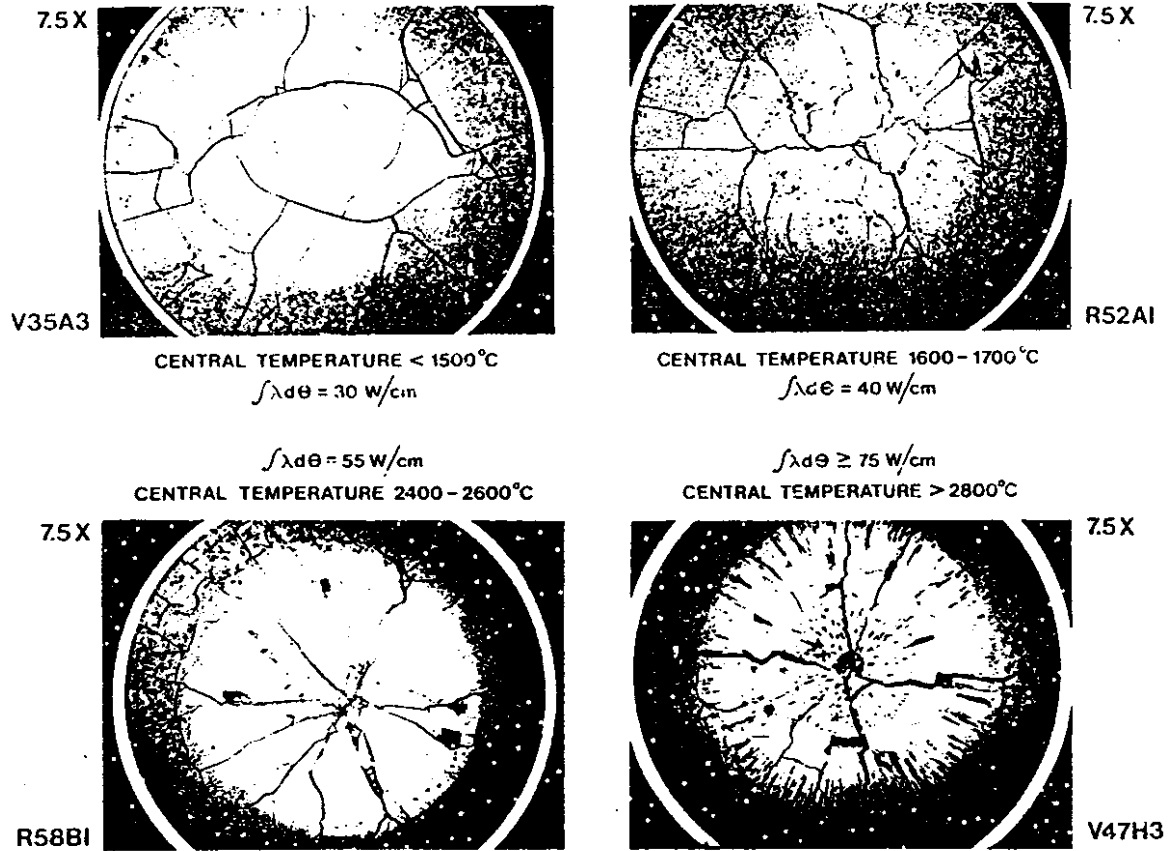

FIGURE 19 Typical Transverse Cross Section of Irradiated UO_2 at Four Power Ratings showing Pellet Cracks and UO_2 Grain Growth

7.1.3 Gas Release

UO_2 releases a percentage of the fission gases that are produced as a natural product of fissioning. The higher the rating or central temperature the greater the amount of gas released inside the elements, therefore space has to be provided to prevent the gas causing excessive pressures at high ratings.

The shape of the gas release curve is shown in Figure 20, which is the plot of experimental measurements of percentage gas release vs rating. The percentage release increases quite rapidly with higher ratings above 4.0 kW/m.

7.2 Zircaloy

Zircaloy is affected during its life by irradiation damage, corrosion, H_2 or D_2 pick-up and stress corrosion cracking(13).

7.2.1 Irradiation or Fast Neutron Damage

Cold work and neutron irradiation both reduce the ductility of the Zircaloy components of the fuel (Figure 21). Indeed the sheathing of some early Douglas Point fuel showed negligible ductility after a fast neutron exposure $3 \times 10^{20} \text{ n/cm}^2$ ($E > 1 \text{ MeV}$). Initial material properties are now specified to retain on average, a 10% total circumferential elongation at 300°C, even after an irradiation of $3 \times 10^{20} \text{ n/cm}^2$. Indications are that material properties are not important to fuel defect performance, however some ductility is considered to be desirable for post irradiation handling of the fuel bundles.

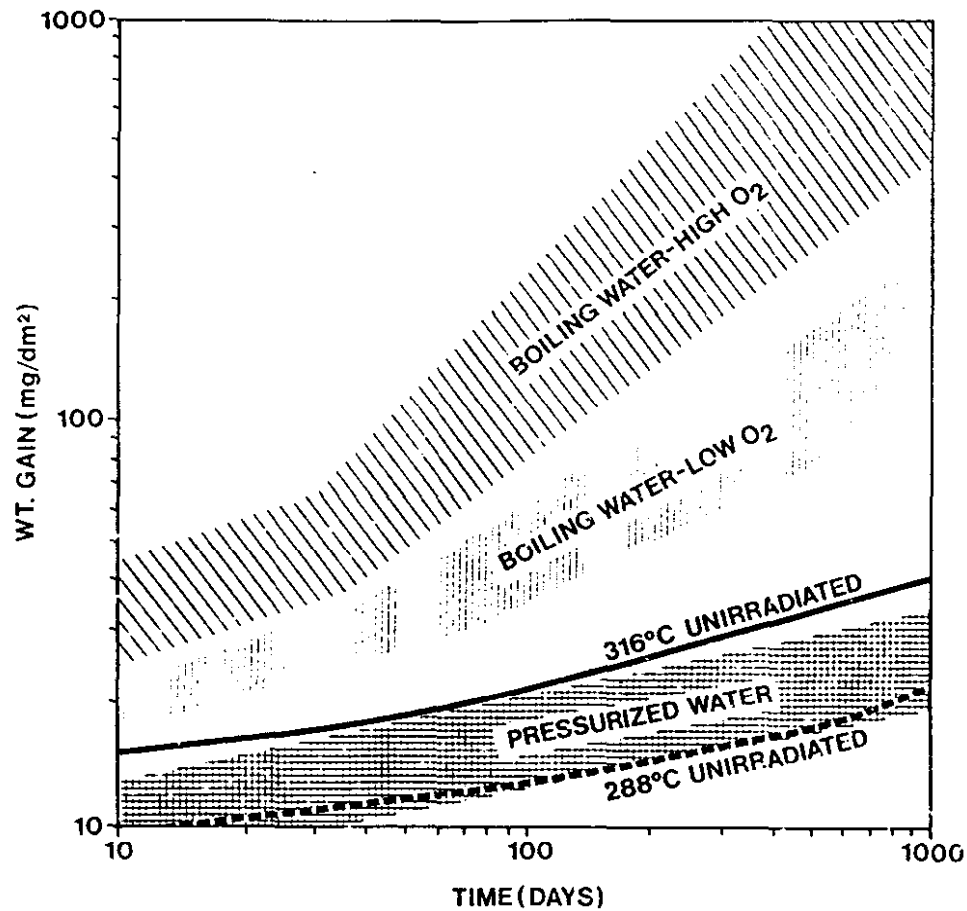

FIGURE 22 Effect of Oxygen on the In-reactor Corrosion of Zircaloy, 270-300°C

enough to cause problems. In boiling water the oxygen content of the coolant should be kept low by chemical additions of ammonia or lithium.

Zircaloy has a marked affinity for H_2 and D_2 , which makes it less ductile at low temperatures, and both the internal atmosphere of the element and the external chemistry of the coolant must be controlled to prevent excessive H_2 or D_2 accumulating in the Zircaloy.

The change in the D_2 concentration in Zircaloy-2 fuel sheathing with time for different coolant chemistries in NPD(T4) is shown in Figure 23, which indicates that with:

- High D_2 gas in the coolant, the oxidation of Zircaloy cladding is similar to that observed out-reactor, but D_2 pick-up by the cladding is considerably greater than that expected from corrosion alone
- Low D_2 gas in the coolant, the oxidation of Zircaloy cladding is greater than that observed out-reactor but the D_2 pick-up is low

Acceptable coolant chemistry conditions to meet the requirements of all the primary circuit material can be specified for all types of coolant, PHW, BHW or BLW.

If the fuel is built with some moisture or another hydrogen source inside the elements, H_2 enters the sheath to form locally hydrided areas and causes the sheath to defect (See figure 24). To avoid this we have taken steps to ensure a very low content of internal H_2 in our elements.

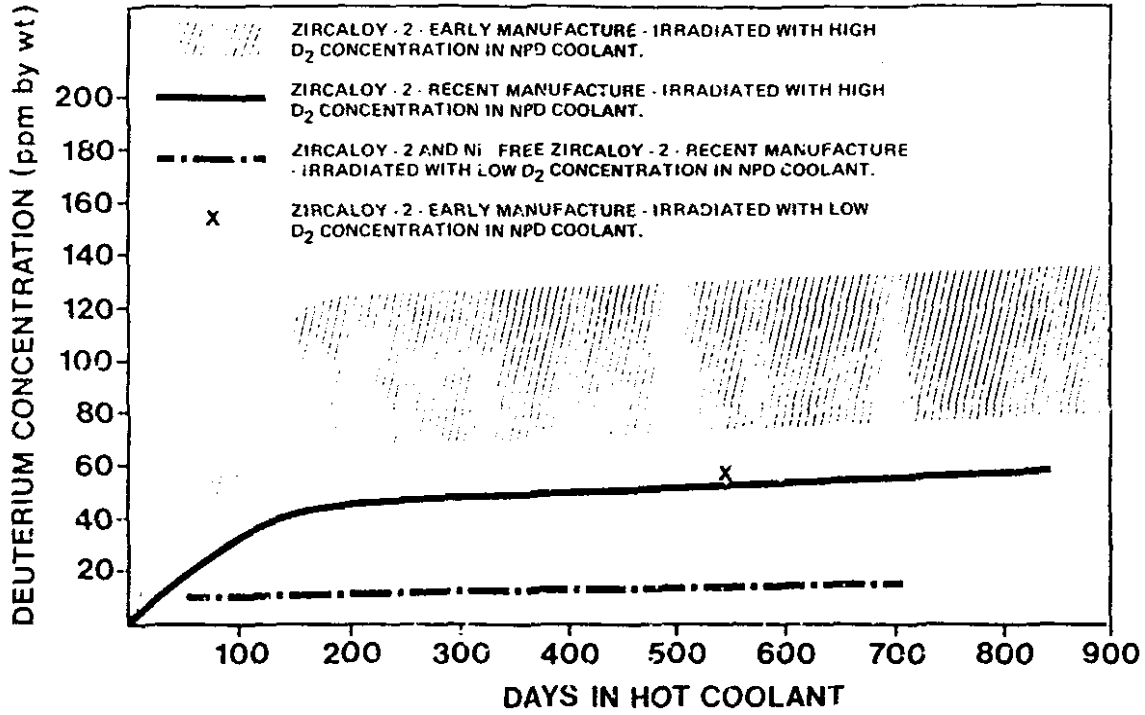
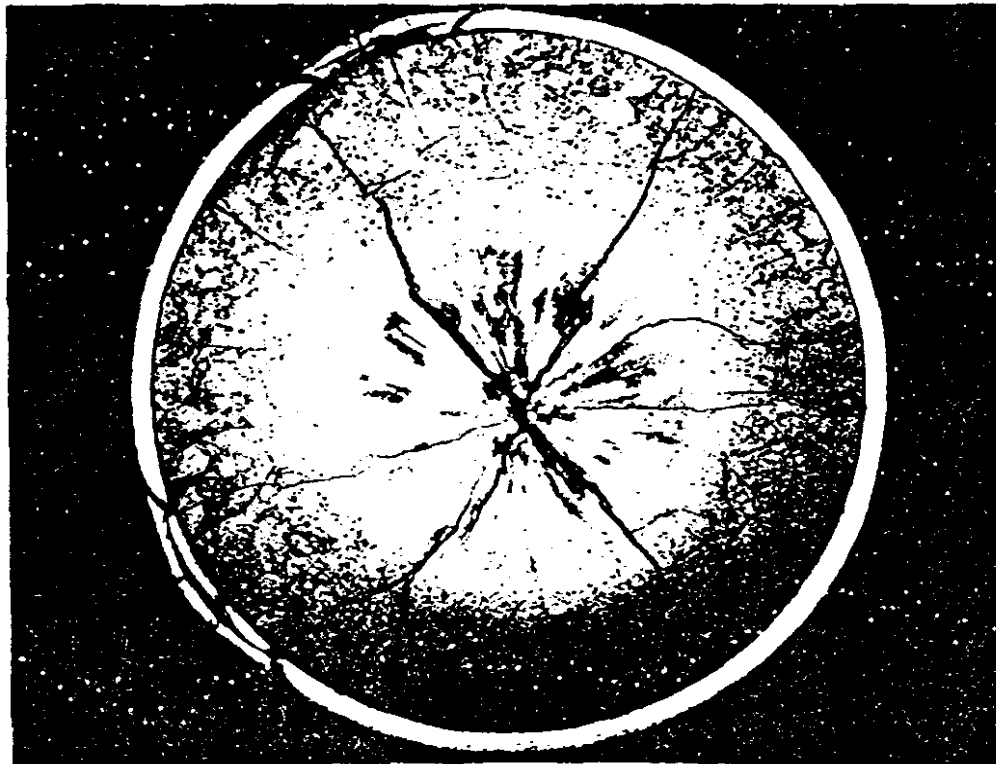

FIGURE 23 Deuterium Pickup of NPD Sheathing

FIGURE 24 Cross Section of Fuel Element showing Zr Hydride Damage



7.2.3 Stress Corrosion Cracking

25

Irradiated zirconium alloys are known to be susceptible to stress corrosion cracking at 300°C in the presence of iodine. Iodine is one of the major fission product gases generated in the fuel. It is postulated that, during power boosts, the fission product iodine from the freshly formed surface of the cracked UO₂ could impinge on the sheath in the stressed region of the crack, thus causing the sheath to fail by stress corrosion cracking Figure 25, (para. 7.6.D).

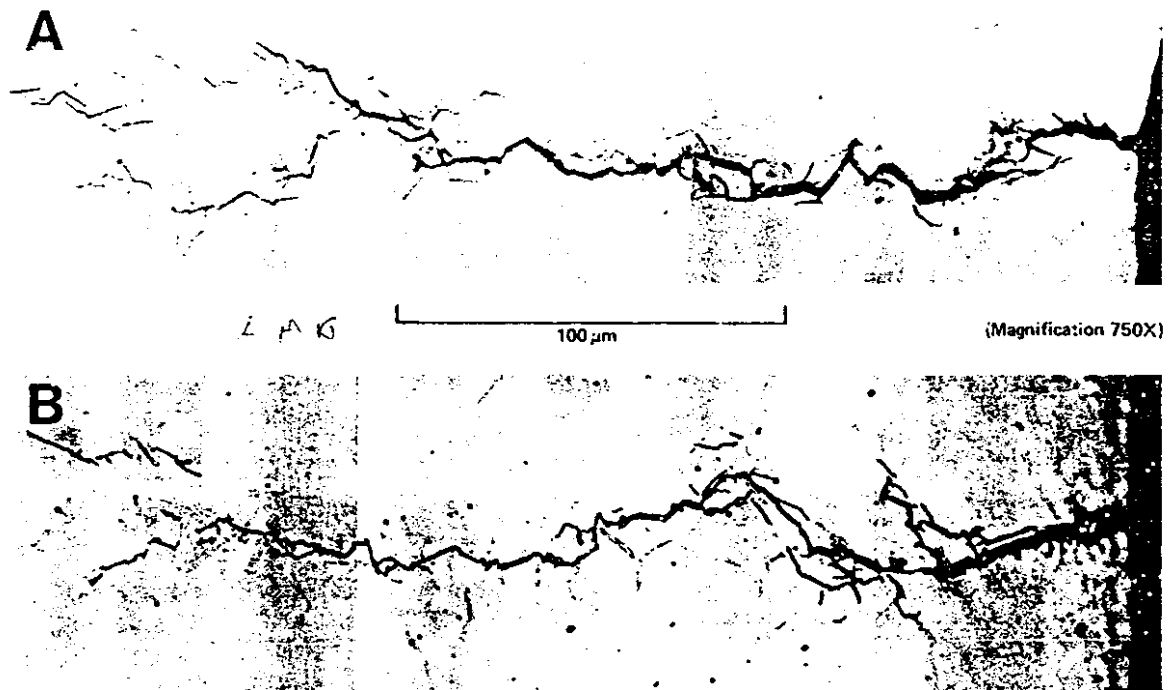

FIGURE 25 Stress Corrosion Cracking

IN REACTOR

7.3 Fuel Element

A fuel element is the basic component of a fuel bundle. In other countries the elements are sometimes referred to as pencils or rods.

The fuel element has to be designed to withstand creep collapse in the high pressure coolant, to accommodate the thermal expansion of the UO₂ without causing any blockage of the coolant, and to contain the internal fission products and gases.

7.3.1 Sheath Collapse

Fuel sheathing, depending on wall thickness, will creep down under the effect of coolant pressure and irradiation unless supported by the UO₂ pellets. In thin wall elements, primary collapse or wrinkling of the sheath is prevented by controlling the diametral gap between pellet and sheath to small values, and by ensuring that the specified wall thickness and mechanical properties are maintained.

7.3.2 Element Thermal Expansion

The deformability of UO₂ pellets has recently been evaluated by using resistance strain

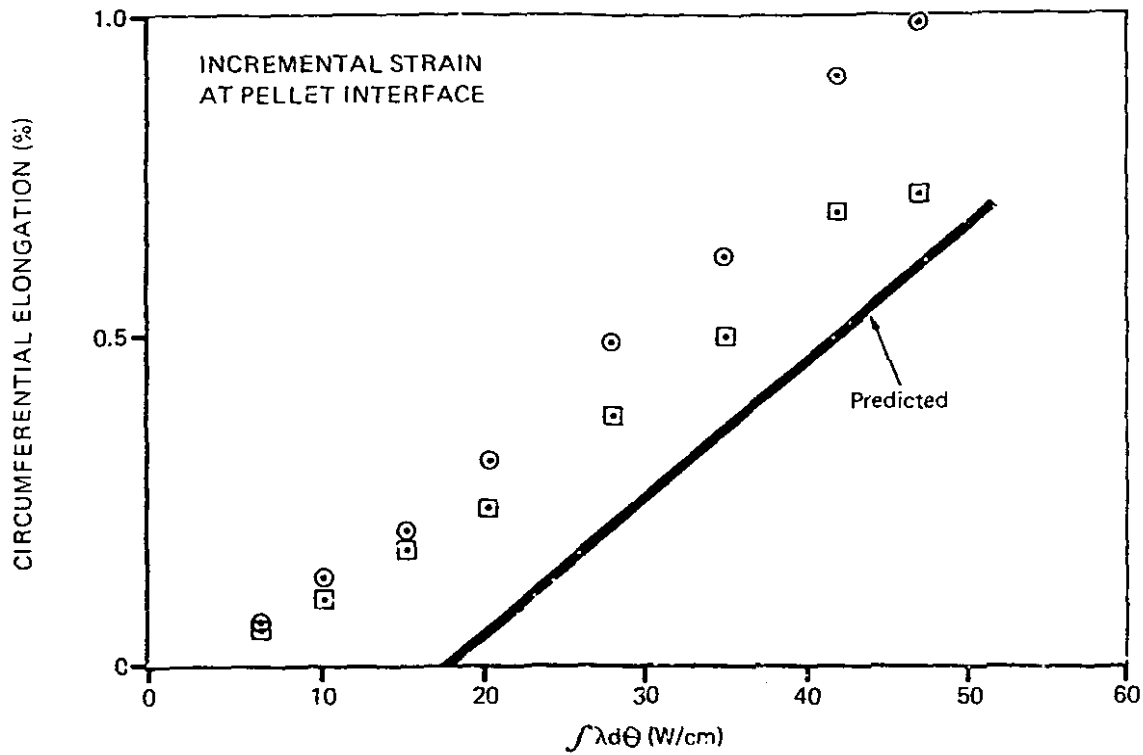
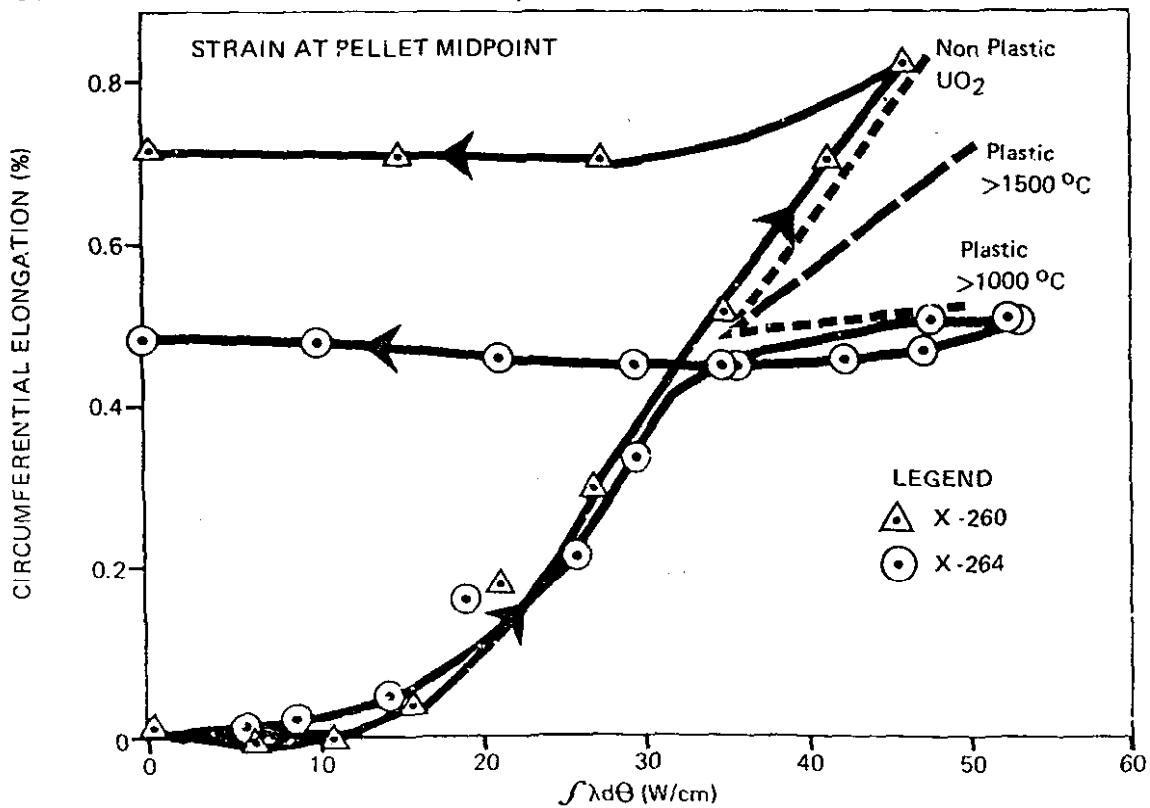

FIGURE 26a Pellet Interface Circumferential Strains Measured with Resistance Strain Gauges during the First Power Cycle (two different tests) compared with Calculated Expansions

FIGURE 26b Mid Plane Circumferential Strains, ditto



gauges to measure the circumferential expansion of the sheath as a function of power. The effects of start-up rates on fuel expansion and the strain (fatigue) cycle to be expected in a load-following reactor have been investigated. The results obtained in two separate experiments are shown in Figure 26b. For the first cycle from zero to full power and back to zero power, they agreed well with each other and with the values calculated from simple physical models. However, while the two batches of UO_2 were thought to be identical, one seemed to deform plastically above $1000^\circ C$ while the other showed non-plastic behaviour up to the maximum temperature of about $1800^\circ C$ for the rate of power increase in this experiment.

At each pellet interface a circumferential ridge is formed in the sheath, producing a "bamboo effect" which is visible on high rated fuel. The top graph of Figure 26a indicates the local circumferential strain that occurred at this interface and the predicted value. The sum of this and the strain at the peller midpoint gives the maximum local strain of the sheath.

Figure 26b also shows that the sheath recovers very little of its strain as the power is reduced. During subsequent power cycles the recovery is even less, and after an irradiation of about ten days, a return to zero power causes approximately 0.1% change in sheath circumference. Such small changes in average sheath strain could partly result from strain localization.

7.3.3 Fission Gas Pressure

The interrelationships between fuel expansion, the pressures caused by fission-product-gas release and the fuel-to-sheath heat-transfer coefficient are complex. The fuel-to-sheath heat-transfer coefficient decreases as the internal gas pressure increases, and this effect causes one of the major uncertainties for predicting fuel behaviour. So, for the design of power-reactor fuels, we impose the condition that the maximum internal gas pressure should not cause significant sheath strain.

The interrelations between various operating parameters are shown in Fig. 27, using the convention that $A \longrightarrow B$ means that a change in A affects B. The complex relationship requires a computer program which is available to predict the behaviour.

FIGURE 27 Fuel Sheath Interactions

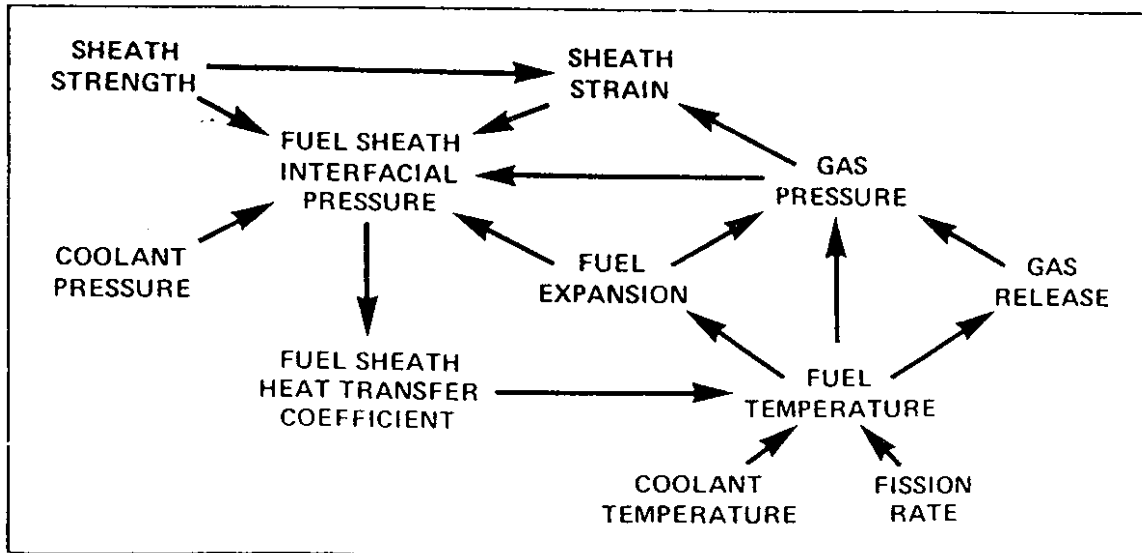

Recent experiments have shown that ELESIM II is conservative in estimating internal element conditions in high powered elements and that gas pressure should not be a concern for current reactor designs.

7.3.4 Hydraulic and Fuelling Machine Loads

These loads are supported by the column strength of the fuel element which is affected by the diameter, wall thickness and mechanical properties of the element tubing. It has been found by both out-reactor and irradiated bundle testing, that the fuel elements have strength requirements in excess of hydraulic and fuelling machine load requirements.

7.4 Fuel Handling System

All Canadian power reactors are designed for on-power fuelling⁽¹⁵⁾. The system is basically similar for all reactors but the machines and systems for Douglas Point, RAPP,* Pickering and the proposed 600 MWe PHW reactors differ in detail from those for NPDP, KANUPP† and Bruce.

A flow diagram of the overall fuel handling system showing the various steps from new fuel into the reactor to spent fuel discharged to the storage bay, is shown in Figure 28 for Pickering, in Figure 29 for Bruce and Figure 30 for the 600 MWe reactor.

The fuelling operations for these stations begin with the semi-manual loading of new fuel bundles into the magazines through the two new fuel ports after which the ports' loading gates are sealed. Subsequent fuel changing sequences are all performed by remotely-operated equipment behind heavy biological shielding, with operator discretion on the degree of utilization of available, fully programmed automatic control. Two fuelling machine heads, equipped with internal rams and magazines, are connected and sealed to the new fuel ports where one of the magazines is loaded with the required quota of new fuel bundles for the planned fuelling operation. The machines then move to opposite ends of one of the reactor's fuel channels. The heads are connected and sealed to the channel ends, topped up with reactor grade heavy water and pressurized to match channel coolant pressures. A leak check is then performed on the head-to-channel seal. The heads next remove and store the channel closure and shield plugs in their magazines. New fuel bundles are inserted into the channel by one of the heads with spent and/or partially spent bundles being received from the channel by the other. The heads then replace the channel shield and closure plugs and, after depressurization of the F/M followed by a leak check on the channel closure, the machines are disconnected from the ends of the channel. After visiting channels as programmed, the machines move to, and seal their heads to spent fuel ports. The spent fuel bundles are then discharged rapidly in air from the heavy water environment of the fuel transfer equipment to the light water environment of the equipment which carries them to the spent fuel bay. There they are stacked for long-term storage under water in the bay, using semi-manually operated remote handling equipment.

Photographs of the Pickering and Douglas Point fuelling machines are shown in Figures 31 and 32.

* "RAPP" Rajasthan Atomic Power Project

† "KANUPP" Karachi Nuclear Power Project

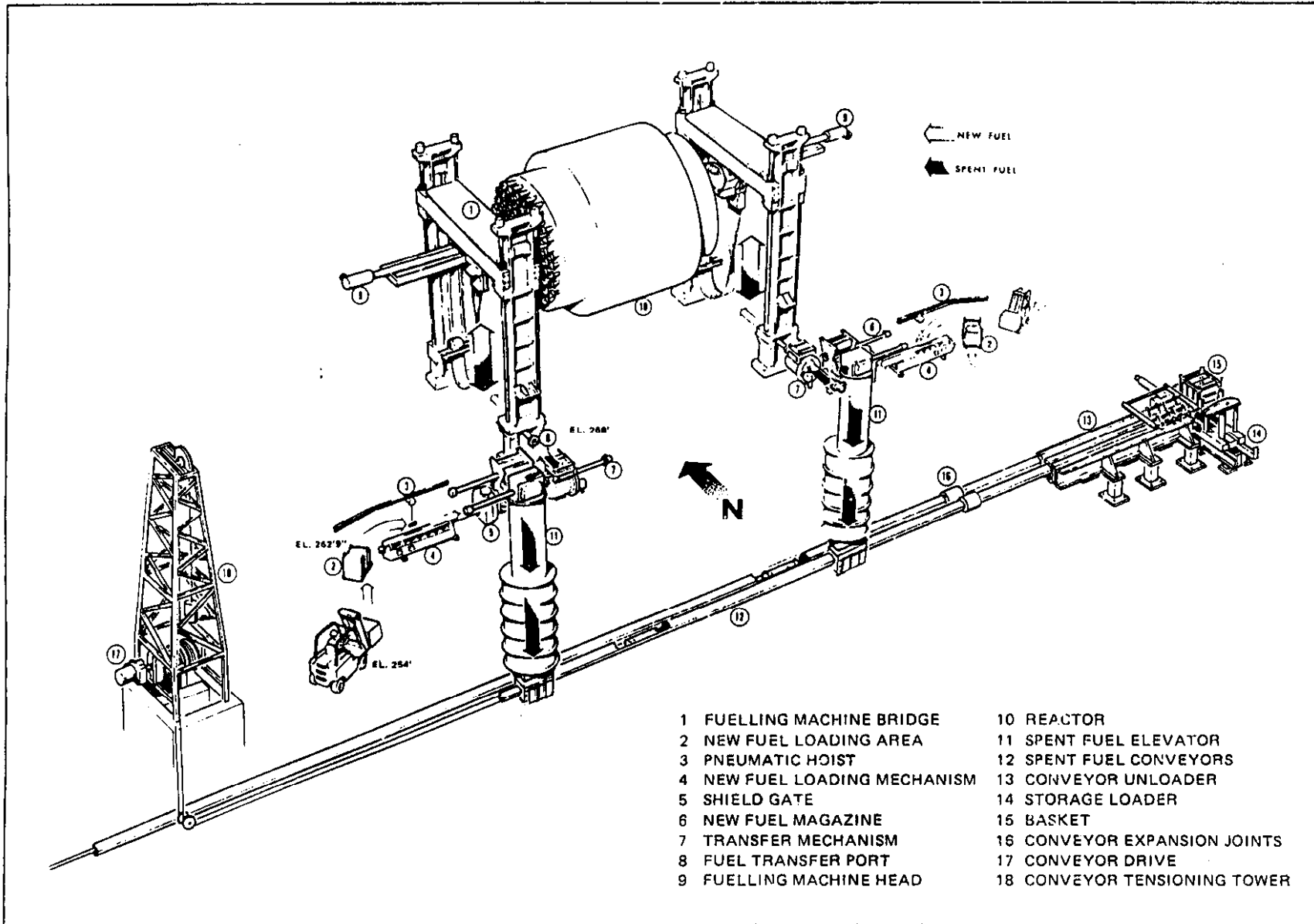

FIGURE 28 Pickering Fuel Handling System

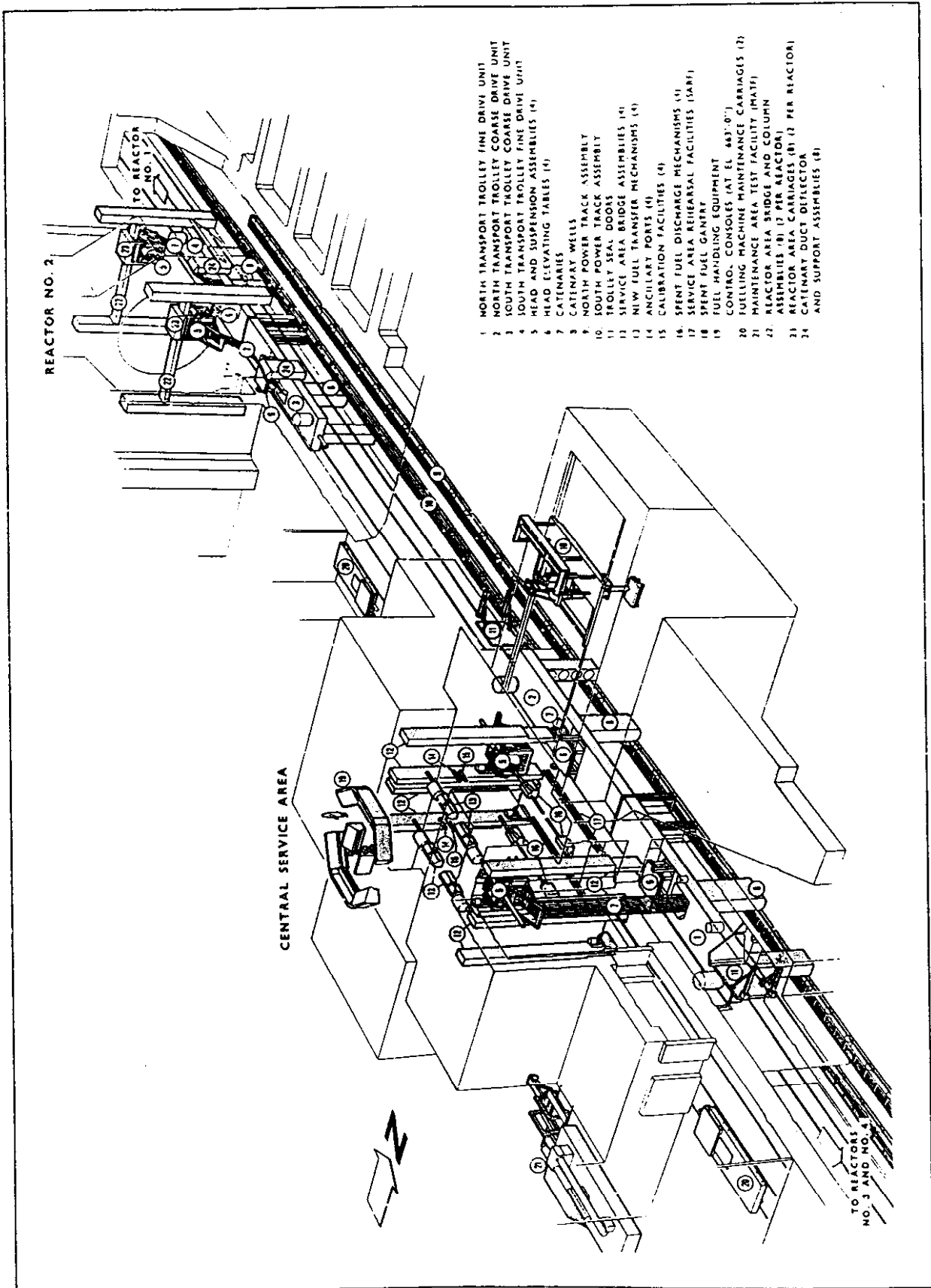

FIGURE 29 Bruce Fuel Handling System

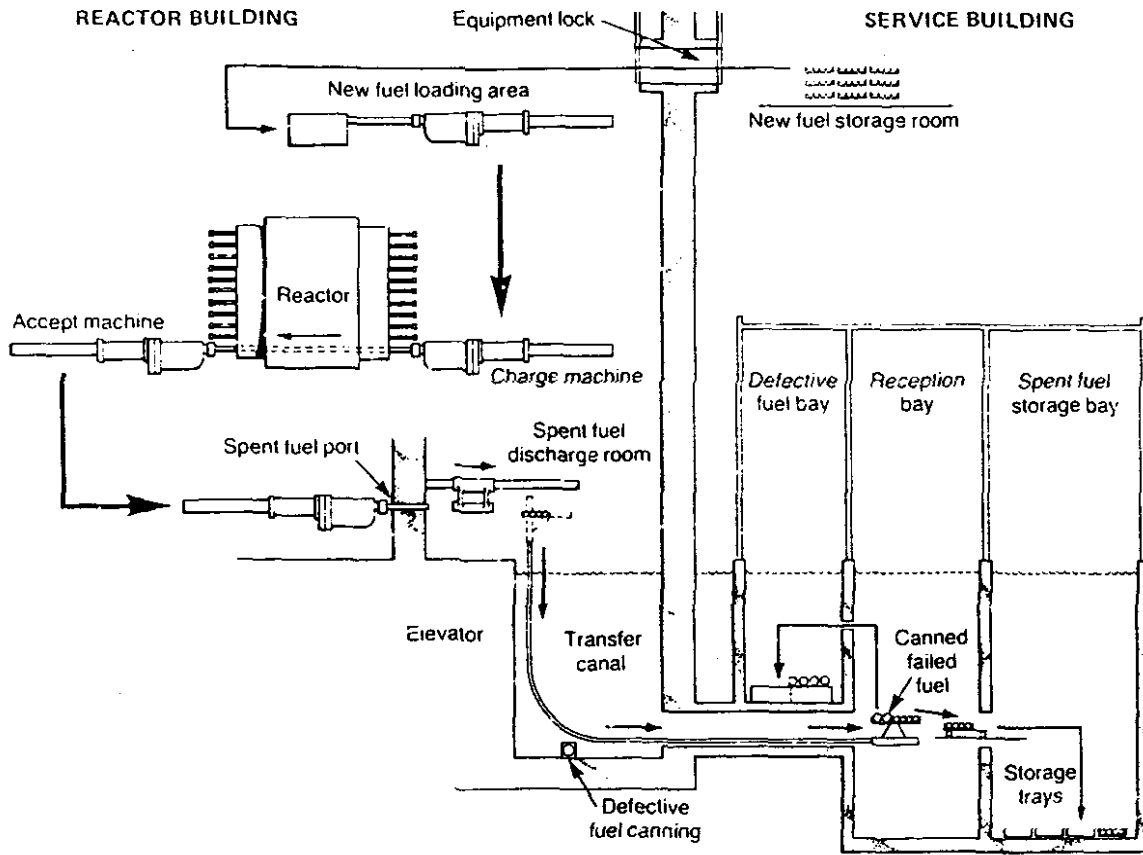

FIGURE 30 600 MWe Reactor Fuel Handling System

FIGURE 31 Pickering Fuelling Machine



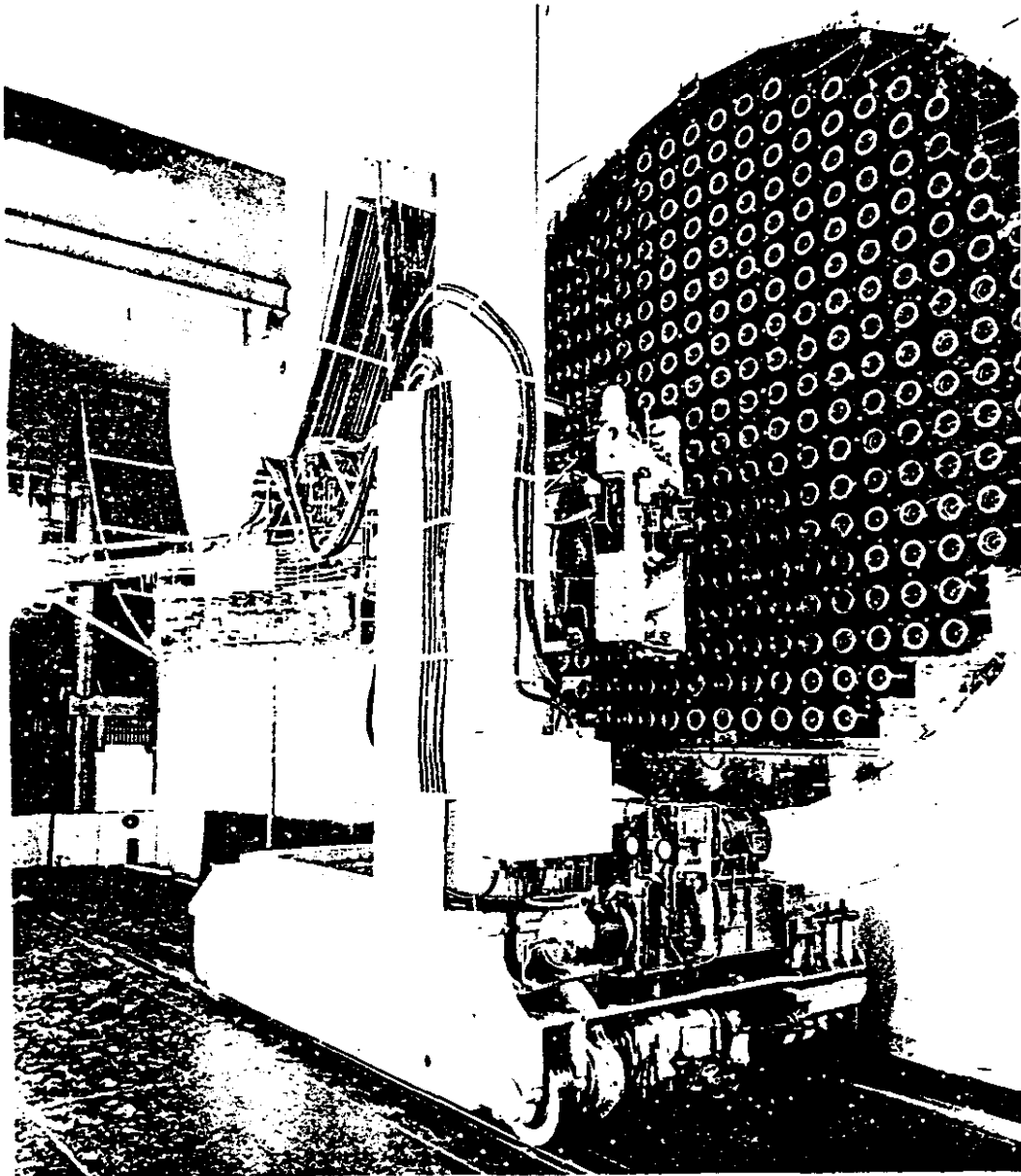

FIGURE 32 Douglas Point Fuelling Machine

7.5 Fuel Bundle Testing

The bundle must:

- 1) Be compatible with the reactor coolant system when producing the design power
- 2) Be able to withstand forces imposed upon it during fuel transfer and on-power fuelling
- 3) Be able to withstand the maximum design power rating and the expected burnup
- 4) Be able to withstand the power changes due to fuelling, reactivity mechanism or reactor power cycles.

without either severely distorting or defecting the sheathing, end caps or welds of the elements:

To ensure that these conditions are met, all fuel bundle designs are given the following tests before they are committed to production.

7.5.1 Out-Reactor Tests:

- 1) Pressure drop — tests are done on a full channel of fuel bundles over a range of coolant flows and orientations in hot pressurized water
- 2) Endurance tests — fuel bundles in a channel are run at maximum flow condition for many thousands of hours to ensure that they do not fret or mark the pressure tube. The wear of the spacer between elements is monitored to ensure that the design meets the lifetime requirements of the fuel in the reactor
- 3) Wear tests — the bundles are subjected to wear tests to check that the bundles will not wear the pressure tube during its lifetime and the bearing pads will not lose more than the allowable amount during their passage through the reactor
- 4) Strength tests — various strength tests are performed to ensure that the bundles can withstand the various loads imposed on them during on-power fuelling. It has been found that the bundles are very strong in compression when contained in the pressure tube.

7.5.2 Irradiation Testing

Bundle designs are proof-tested by irradiation in the AECL loops (Table V) in the NRU test reactor at CRNL. Enrichment is used to achieve power ratings in excess of the design rating and irradiation is continued beyond the expected service burnup.

To test for the ability of the fuel to withstand power changes, bundles are irradiated at low powers in NRU and then moved to a higher power position in the reactor. Power boosts are the same as, or higher than those expected in the power reactor.

TABLE V AECL Loop Data

LOOP	PRESSURE I.D. (mm)	DESIGN OPERATING		
		PRESSURE MPa (GAUGE)	TEMPERATURE °C	MAX. FUEL POWER kW
CRNL-NRX				
X-1	23.6	13.79	316	240
X-2	37.6	13.79	316	100
X-3	23.6	13.79	316	400
X-4	37.8	15.17	566	250
X-5	82.8	17.24	316	550
X-6	37.8	13.79	316	300
X-8	25.4	0.86	100	0
CRNL-NRU				
U-1	101.6	12.41	538	8000
U-2	101.6	10.34	316	8000
U-3	101.6	4.14	427	4500
U-5	69.8	13.79	327	0
WNRE-WR1				
IL2	45.7	7.58	294	900
IL4	69.8	6.89	427	4500
IL5	69.8	6.89	427	4500
IL6	69.8	6.89	427	9500

7.5.3 Pressure and Temperature Cycles

Due to changes in primary circuit pressure and temperatures, the fuel sheathing will experience various pressure and temperature cycles during its life. To date, we are unaware that this adversely affects the fuel sheath's performance life, as fuel in NPD, Douglas Point, Pickering and CRNL irradiations has experienced many hundreds of cycles without deterioration.

7.5.4 Power Cycles

CANDU reactors are designed as base load stations with continuous on-power fuelling. The heavy swing to nuclear power in the utilities' systems will require increasing pressure on the reactors to follow daily loads. Considerable experience has been obtained with daily power cycles with the CANDU KANUPP reactor in Karachi, which has been following the daily grid demands and accumulated hundreds of power cycles without any performance change in fuel. We have been informed that the RAPP-1 reactor in India is also successfully load following to meet the grid demands.

7.6 Fuel Bundle Performance

7.6.1 Statistics of Fuel Bundle Performance

The in-service performance of CANDU fuel has been excellent. Of the 92,593 fuel bundles irradiated up to March 1976, in nine CANDU reactors (totalling 2,840 MW(e), 99.73% have performed as designed (16,17) (Table VI). It should be noted that these statistics are based on bundles, not defective pins, elements or rods, which, if used, would improve the statistics

TABLE VI CANDU Fuel Performance (March 1976)

Station	Irradiated	Discharged	Defective	% Defective
NPD	3,688	2,580	11	0.30
DOUGLAS POINT	13,079	9,447	85	0.65
Before Jan. 1, 1972	7,169	3,537	66	0.92
After Jan. 1, 1972	9,542	5,910	19	0.20
PICKERING G.S.				
Unit 1	19,818	15,138	99	0.50
Before Nov. 1, 1972	6,938	2,258	91	1.31
After Nov. 1, 1972	17,560	12,880	8	0.05
Unit 2	18,384	13,704	1	<0.01
Unit 3	13,314	8,634	6	0.05
Unit 4	10,314	6,234	4	0.04
PICKERING G.S. TOTAL	62,430	43,710	110	0.18
KANUPP	4,603	2,315	30	0.65
RAPP ^e estimated	5,480 ^e	1,800 ^e	5	0.09
GENTILLY - 1	3,313	293	12	0.36
TOTALS	92,593	60,145	253	0.27

by an order of magnitude i.e. 0.03% defective. Of the relatively few defects that have occurred in CANDU fuel, most could be attributed to a single cause — sheath rupture due to a substantial power increase following a prolonged period of low power. An example of a defect in Douglas Point wire wrap first charge fuel is shown in Figure 33. These power increases can be caused by the movement of fuel during fuelling or by changes in flux due to nearby reactivity mechanisms. The description of the power changes causing power ramp defects both in Douglas Point and Pickering, are described in detail in Reference 16 and the physics is described in para. 8.0. It is suggested that this behaviour will also apply to other reactors where the fuel is exposed to power changes caused by fuelling, movement of control rods and gross reactor power changes after periods at low power. This behaviour was originally indicated by analyses of the operating records from the Douglas Point reactor, and later, from the records of Pickering Unit 1.

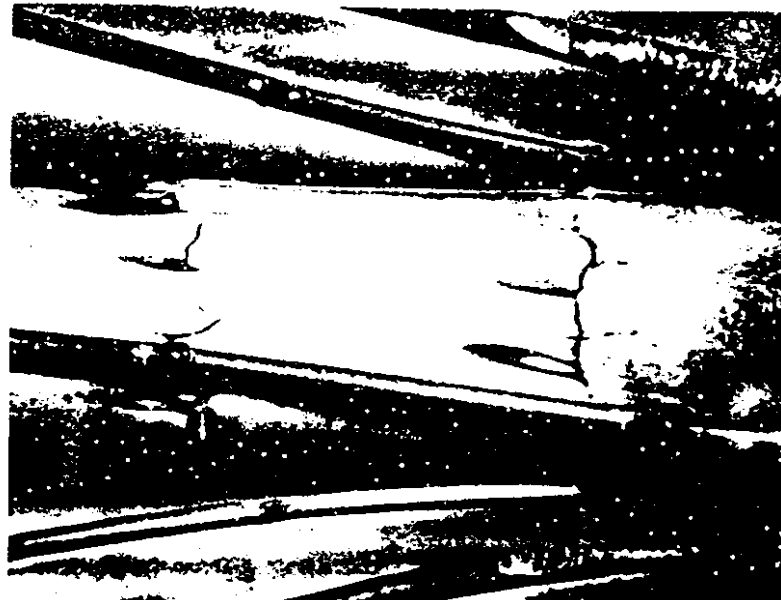

FIGURE 33 Example of Douglas Point Defect

7.6.2 Defect Mechanisms

Laboratory and in-reactor experiments identified two mechanisms which can cause cracking of fuel cladding during power ramps. The primary mechanism is stress corrosion cracking associated with the fission product iodine at specific combinations of stress and iodine concentrations (18, 19, 20, 21). Similar experiences have been reported in Europe (22, 23). The other mechanism is mechanical interaction of the pellet with the sheath causing tensile failure of the fuel cladding without the assistance of iodine stress corrosion cracking. Examples of these defect mechanisms are shown in Figure 34. It has been found that the necessary concentration of both stress and strain can be produced by the radial cracks formed by thermal expansion of the UO_2 at interfaces between pellets, and over small chips of UO_2 wedged between the fuel and sheath. Cracks in the sheath are formed at high stress areas when there is a boost in power after a low power soak.

After identifying the cause of the fuel defects, the immediate remedy at the stations was to modify the fuel management schedule to avoid power increases that led to the original defects. Since 1972 this has resulted in a marked drop in the defect rate equal to, or below the design target of 0.1% (16). A "zero defect" target appears to be an unwarranted expense in view of the fact that defects can be removed from CANDU plants without shutting down.

From a reactor operator's point of view, any restrictions to fuel management or reactor power maneuvering are undesirable. A program has therefore been instituted in the test reactors to provide a fuel design more tolerant to power increases. A preferred solution is designated Canlub (24, 25, 26) which incorporates a thin graphite layer between the UO_2 and the sheath. The graphite acts as a lubricant between the UO_2 and the sheath, reducing stress concentrations and possibly also acts as a barrier to the chemical attack of the Zircaloy by the iodine under these stress conditions. Loop tests have shown a significant improvement in the performance, and modifications have been introduced into all CANDU fuel production with minimal cost penalties.

FIGURE 34 Defect Mechanisms

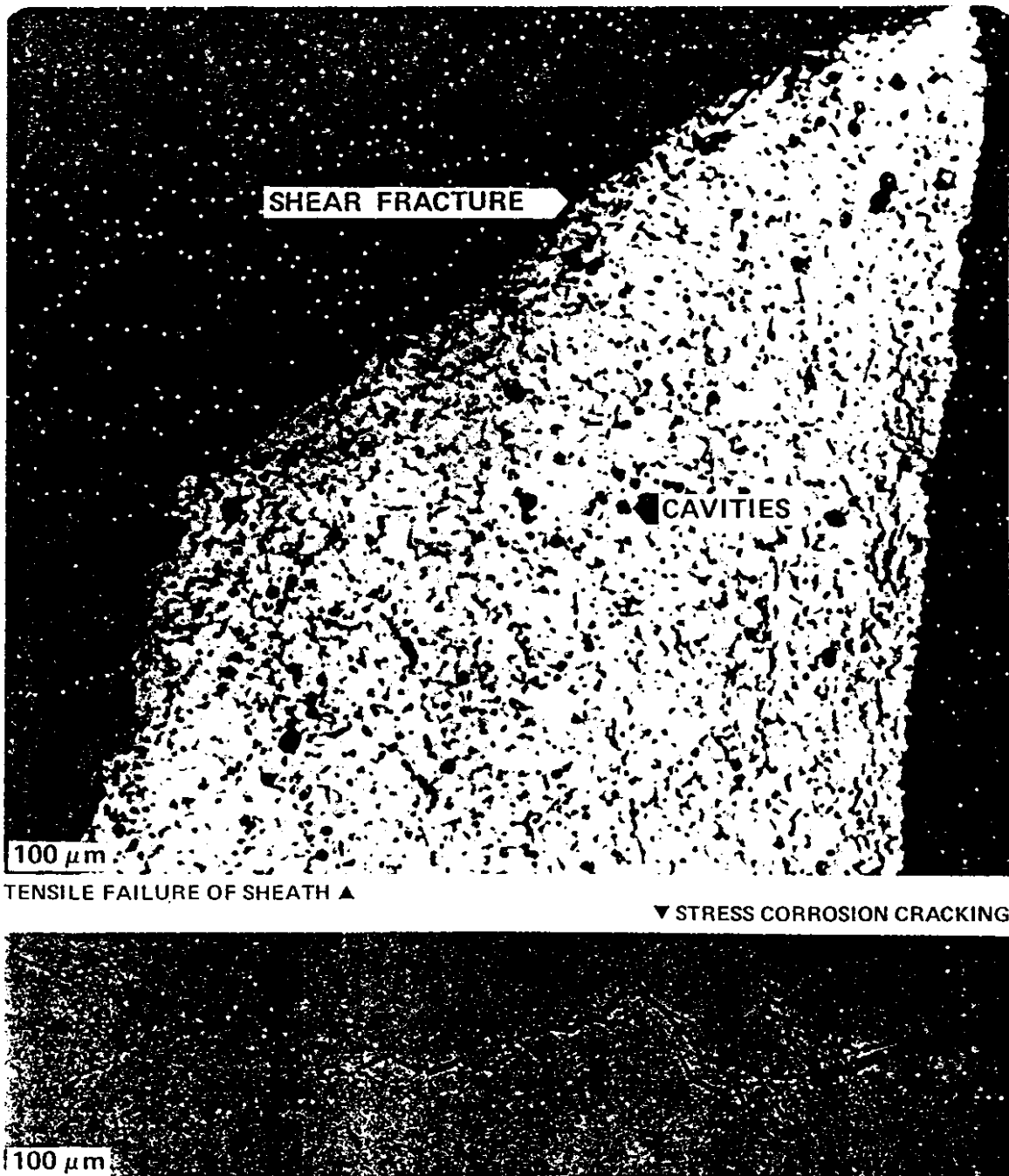

7.6.3 Fuel Performance Criterion

37

Analyses of fuel performance data has produced a reliable fuel performance criterion (27). This criterion has been successfully employed to avoid defects which can be induced by fuel management, reactivity mechanism movement, and gross reactor power increases. The four important parameters affecting the defect behaviour are:

- 1) Maximum element power per unit length during power change
- 2) Power increase
- 3) Fuel burnup
- 4) Time at maximum power

The proposed fuel sheath interaction model using these parameters is shown in Figure 35.

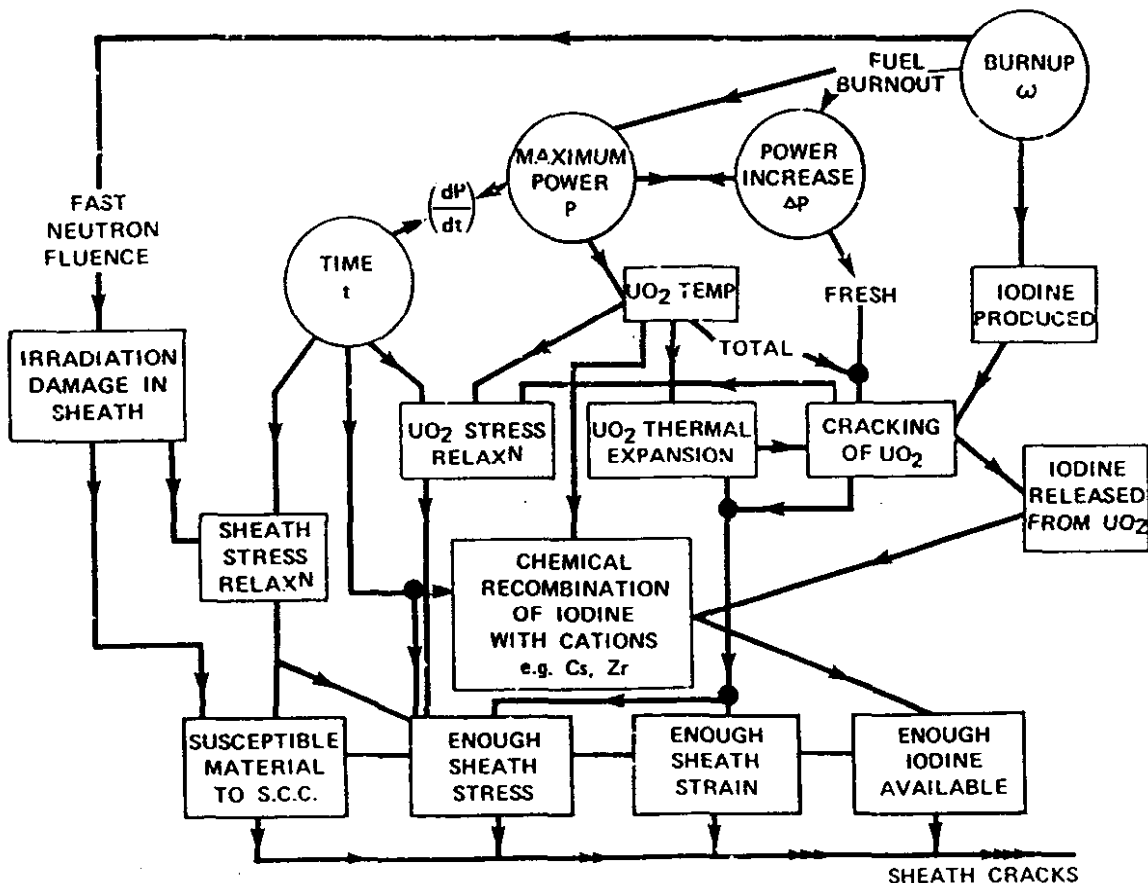

FIGURE 35 Stress Corrosion Cracking Model

This criterion is based on a statistically significant number of operating fuel bundles and may be applicable to other reactors using Zircaloy and UO₂ to prevent power ramp defects (28).

The fuel performance criterion (27) is illustrated in Figure 36 in the form of a fuelogram which is a plot of element linear rating vs change in power for various element burnups. The probability of defect (at a given burnup) increases when the equations for both the maximum element power and power increase are greater than 0.

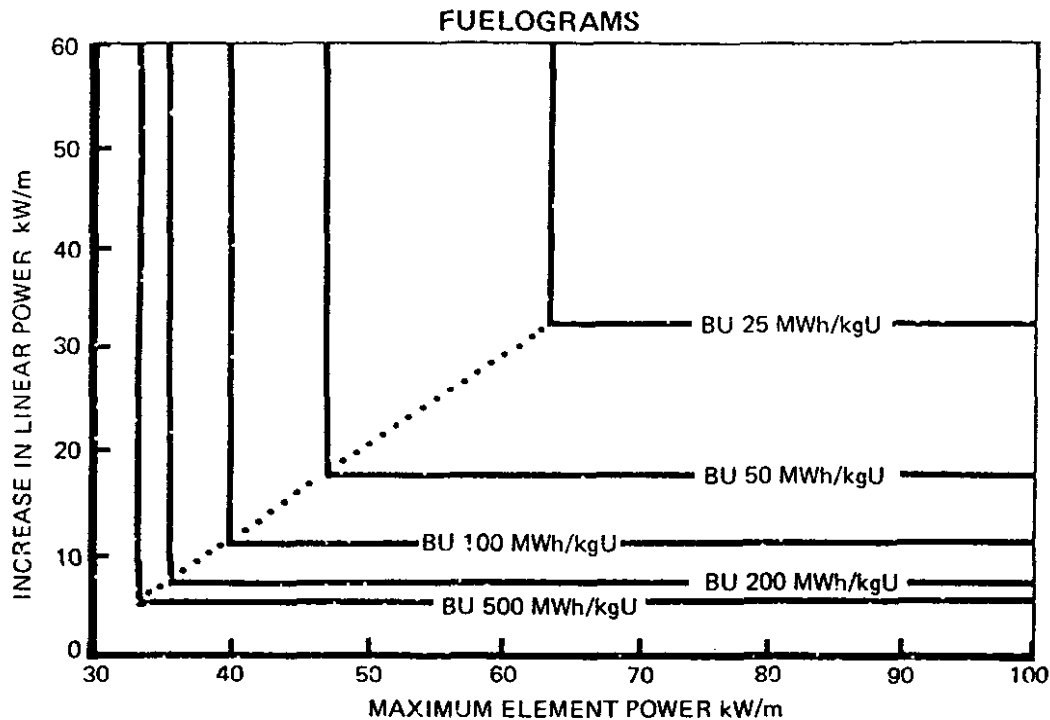

FIGURE 36 Fuelgrams

During the commissioning of the CANDU-BLW reactor Gentilly-1, it was found to be beneficial to raise the reactor to full power in small power increments with an overshoot and a hold at each step. This prevented the fuel experiencing a large power increase which could have caused a significant number of defects predicted by the defect criterion. The procedure was necessary due to the prolonged period of low power during commissioning.

The speed of response to any unforeseen problem is determined by two factors – the time taken to identify the problem and the time to find and implement a solution. The identification of the defects and their causes was greatly facilitated by CANDU reactor design. The capability of monitoring activity release from individual fuel channels allowed the incidence of failures to be correlated to reactor parameters. It was also possible to identify the defected bundle in the channel. The capability of on-power fuelling meant that fuel could be discharged immediately and examined before any evidence was destroyed by secondary damage. The use of heavy water coolant permitted the distinction between sheath hydride due to in-service corrosion and that due to internal contaminants. In fact little hydrogen (as opposed to deuterium) was observed in the sheaths of failed elements so we were not misled into attributing the failures to hydrogenous contaminants.

7.7 Bundle and Element Behaviour Under Extreme Conditions

Zircaloy clad UO_2 fuel can survive extreme conditions for limited periods of time such as gross overpower and dryout.

7.7.1 Gross Overpower

Gross overpower in excess of $\int \lambda d\theta$ of 7.2 kW/m, can result in a small volume of UO_2 achieving central melting, which causes that fraction of UO_2 which melts to volumetrically

expand 10% greater than normal. The resulting sheath strain can cause rupture. An example of this is shown in Figure 37 which is a cross section of an experimental element taken to this condition. The fuel bundle survived after the defect and was removed from the reactor without difficulty.

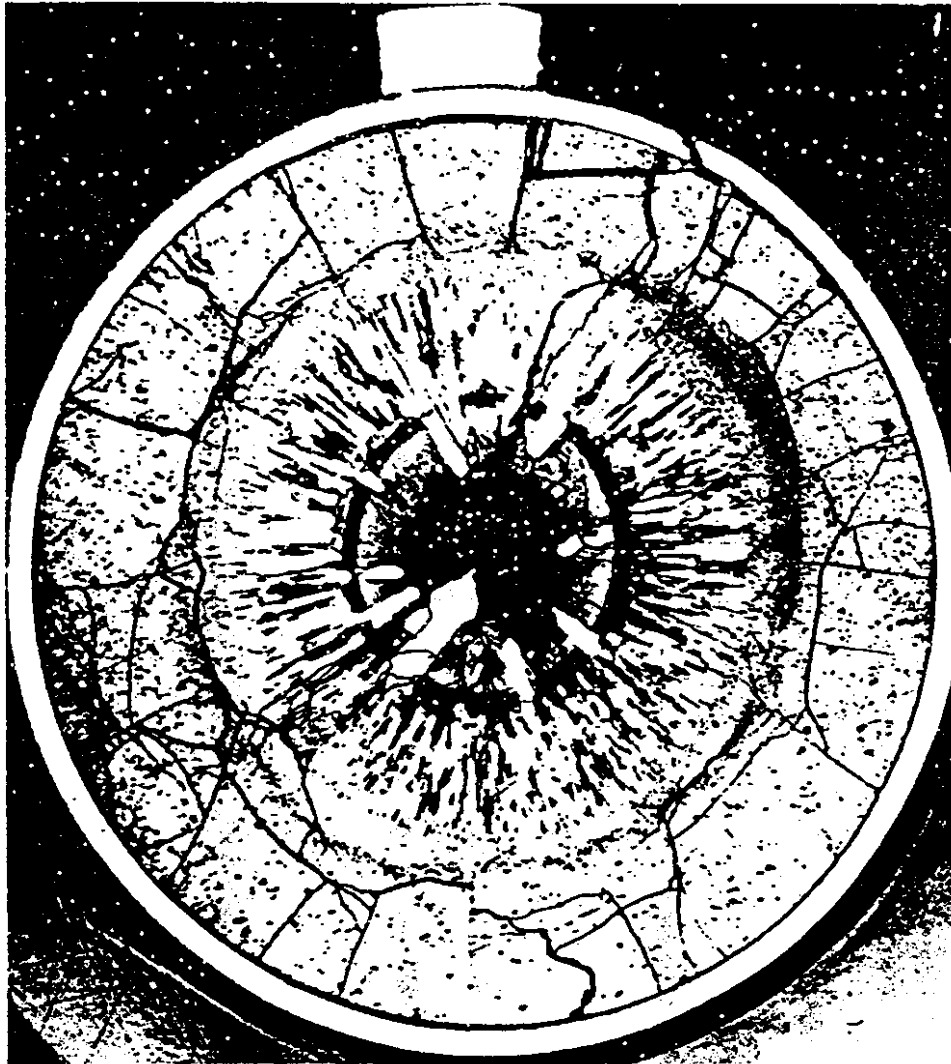

FIGURE 37 Cross Section of Element and Centre Melting in UO_2

7.7.2 Dryout

Canada has pioneered in-reactor heat transfer testing with experimental and power reactor fuels and therefore has gained a large amount of operating experience with fuel in two-phase flow and critical heat flux (CHF) condition or dryout.

All reactor fuel channel conditions are specified so that a significant margin of safety is available to prevent dryout occurring during normal operation.

As noted in Figure 38, dryout will significantly increase the sheath temperature, the amount depending on the coolant conditions and surface heat flux. Zircaloy clad UO_2 fuel elements can operate at these elevated temperatures for limited periods of time, inversely proportional to temperature. The data from various tests are summarized in Figure 39 which is a semi-log

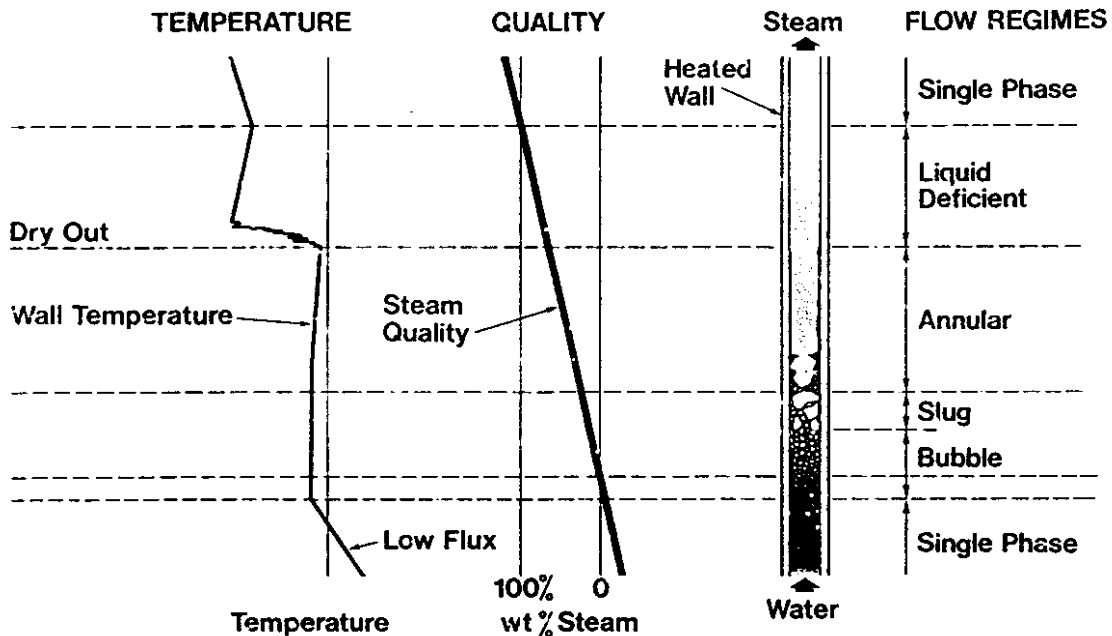

FIGURE 38 Thermal and Hydraulic Regimes in Vertical Upward Flow

plot of time-to-defect vs sheath temperature. The sheaths in experiments with temperatures between 500 and 600°C survived for tens to hundreds of hours, while a number of defects occurred at temperatures between 600°C and 800°C after 10 hours. The points shown as X-4 temperature excursions (non-defective) were obtained from thermocouple readings during three transients. The points at very high temperatures 1000-1600°C were obtained from examinations of the Zircaloy sheath after the irradiation. This is possible because the temperature that Zircaloy has been exposed to can be estimated by its structural appearance, the amount of oxygen diffusion and the zirconium oxide structure and thickness.

These characteristics are dependent on time and temperatures. It is not possible to be precise about temperature *and* time. That is, a short time at high temperature can produce results similar to those at lower temperatures for longer times. However, to first order approximations, this ambiguity does not affect the general trend of the time-temperature plot. If Zircaloy is operated too long at these high temperatures it will oxidize and a sheath failure will occur. An example of this is shown in Figure 40.

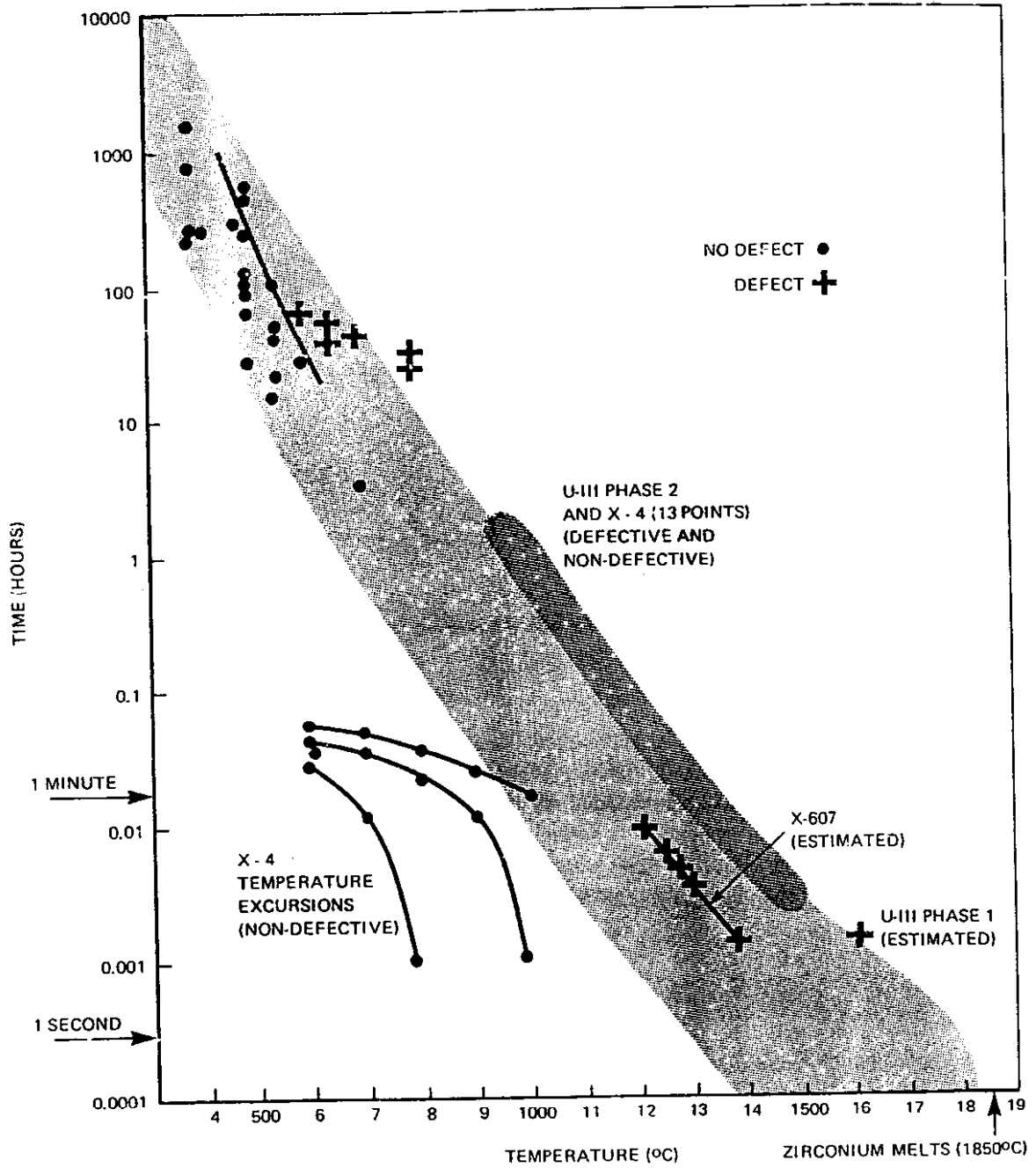
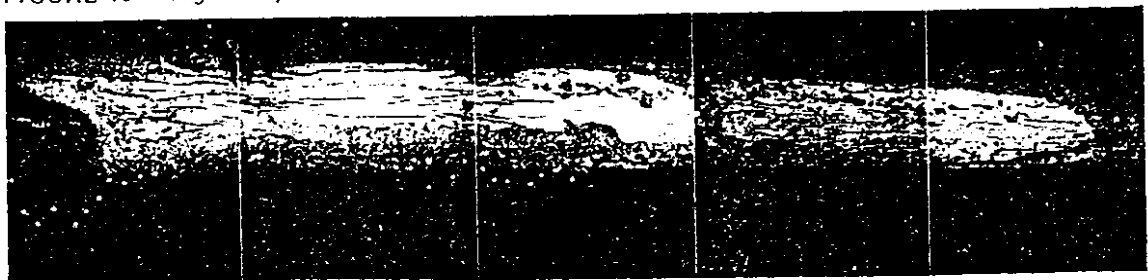

FIGURE 39 Sheath Temperature versus Time to Defect

FIGURE 40 High Temperature Corrosion Failure of Fuel Element



8 FUEL PHYSICS AND MANAGEMENT

After the fuel has been in the core for some time, the buildup of fission product poisons and the depletion of fissionable uranium cause the excess of neutrons produced by the fuel (the "reactivity") to decrease. This process is called "burnup" and is usually expressed in terms of the total energy produced by the fuel per unit mass of initial uranium; that is, in "megawatt hours per kilogram", or "megawatt days per tonne". The rate at which new fuel is added to the core is adjusted so that the reactivity decrease, due to burnup, is balanced by the reactivity increase of the fresh fuel in order to maintain the reactor critical. The refuelling rate determines the average residence time (or "dwell time") of the fuel in the core, hence the average burnup on discharge.

Anything in the core which absorbs neutrons will reduce core reactivity and, therefore increase the fuelling rate to maintain criticality and reduce burnup. The reactor core is designed to use neutrons as efficiently as possible in order to obtain maximum burnup. Core parameters, such as radius, length, lattice pitch, reflector thickness, fuel and channel geometry, etc., are optimized for minimum total unit energy costs. Structural materials, i.e., pressure tubes and calandria tubes, are selected for low neutron absorption — zirconium alloys are used most frequently because zirconium has a low neutron absorption cross-section. Fuel bundles are designed to have as little structural material as possible. In CANDU reactors refuelling is done on-power; no removable absorbers are required to compensate for burnup between refuellings as in other systems. Reactivity mechanisms are the minimum necessary for system control. This improves the burnup as well as the reactor's availability.

The in-core fuel management scheme refers to the manner in which new fuel is added to the core, replacing burned-up fuel. In CANDU PHW reactors, fuel is added on-power by inserting a fixed number of new bundles in one end of a channel and removing the same number of spent bundles from the other end. For example, if 8 bundles are added to a 12-bundle channel, the last 8 bundles in the channel are discharged and the first 4 bundles are pushed along to the last 4 positions. (This is called an "8 bundle shift"). This gives a higher burnup

FIGURE 41 Douglas Point Axial Flux Profile

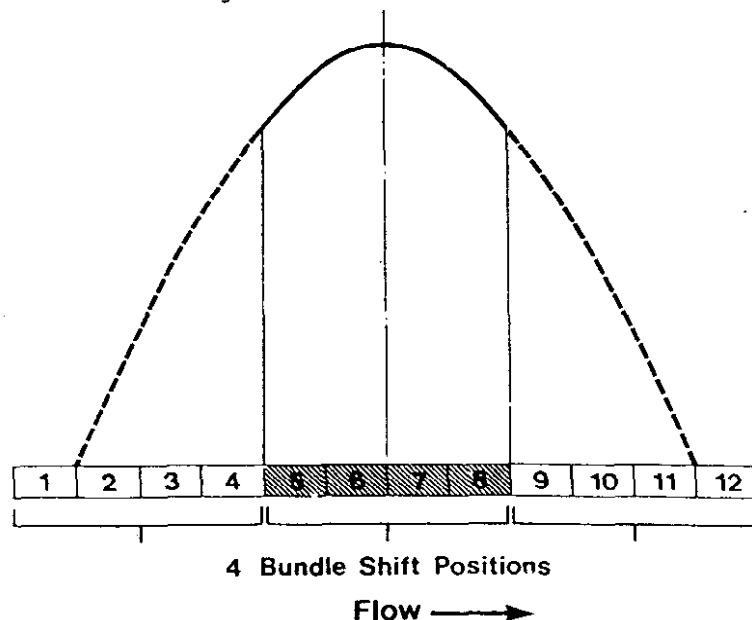

than replacing all 12 bundles at once, because those bundles which were operating at lower power during the first cycle, and consequently have lower burnup, are left in for further irradiation.

Fuel in adjacent channels is pushed through in opposite directions ("bi-directional refuelling"). Thus, fresh fuel in one end of a channel is directly adjacent to partially burned up fuel in the nearest neighbouring channels. This tends to make the average fuel properties uniform along the channel, producing a symmetric axial power distribution which closely resembles a cosine curve (see Figure 41).

The axial neutron flux distribution for NPD, Douglas Point and Bruce reactors is approximately a cosine, but Pickering axial flux shape is distinctly different because it uses absorber rods as a reactivity mechanism, which tends to flatten flux. Figure 42 shows the Pickering axial shape and also illustrates the movement of bundles along the channel during an eight-bundle shift.

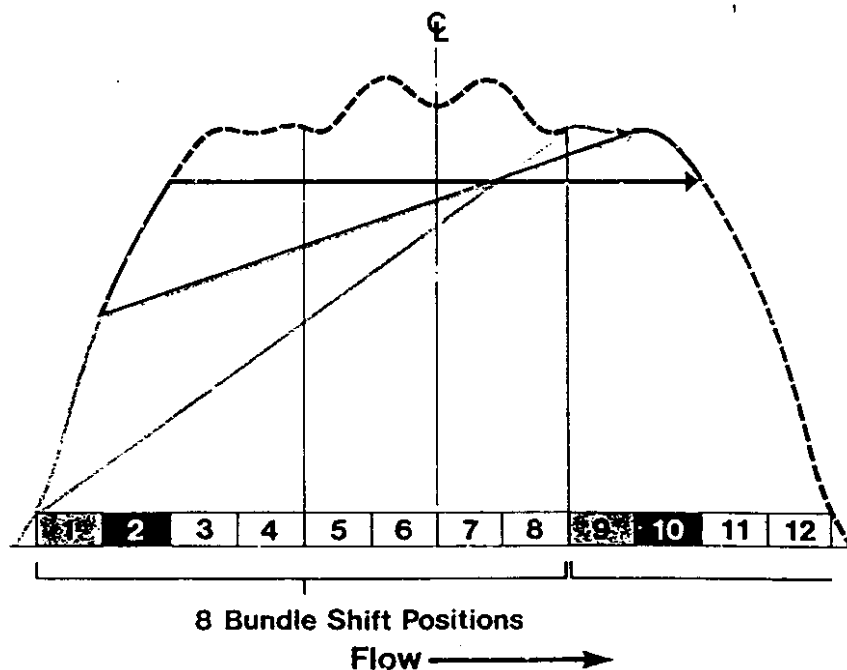

FIGURE 42 Pickering Axial Flux Profile

The radial flux distribution for a bare reactor is a Bessel function but can be modified or flattened to obtain a higher power density from the reactor by a reflector on the outside of the core and/or differential fuelling of the core. The refuelling rate in the inner region is adjusted so that burnup is higher there, and reactivity lower. This tends to reduce power in the inner region, and flattens the radial power distribution. This produces a higher total power generation from the same size core.

8.1 Fuel Bundle and Core Flux Distributions

The radial neutron flux distribution through a fuel bundle is shown in Figure 43. The neutron flux is depressed as it traverses the various components making up the fuel channel, i.e., calandria tube, gas space, pressure tube, reactor coolant and fuel elements. As the CANDU system uses short bundles, there is axial peaking in the neutron flux at each bundle junction (Figure 43).

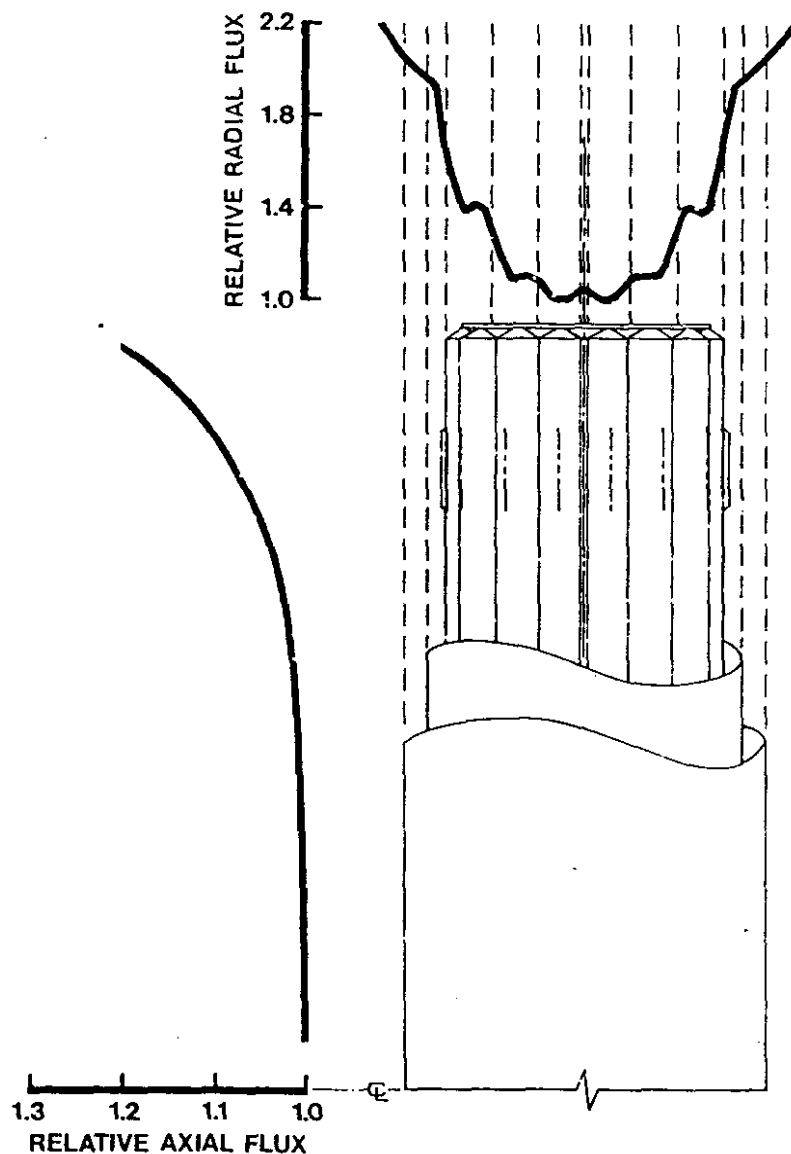

FIGURE 43 Bundle Radial and Axial Flux Distribution

8.2 Reactivity Mechanisms and Booster Rods

To provide the necessary extra reactivity to override the xenon poison growth after a trip from full power, booster rods or absorbers are required. Booster rods are enriched fuel rods stored outside the core until required, whilst absorber rods are stored in the core and are withdrawn to provide the extra reactivity. In Pickering the absorber rods use cobalt for neutron absorption. The irradiated cobalt can be sold as a useful bi-product for medical therapy. The booster rods used in NPD and Douglas Point are modified plate type fuel elements cooled by the lower pressure moderator. Gentilly required more powerful booster rods due to the large light water load. A rod was developed using the techniques developed for the enriched U-Al fuel for NRX and NRU. It consists of a fuel bundle made up of 61 elements using U-Al clad in Al as shown in cross-section in Figure 44. A more powerful booster rod has been developed for the Bruce reactor and consists of 18 annular elements formed by co-extruding U-Zr with Zr and assembling the six bundles as shown in Figure 45.

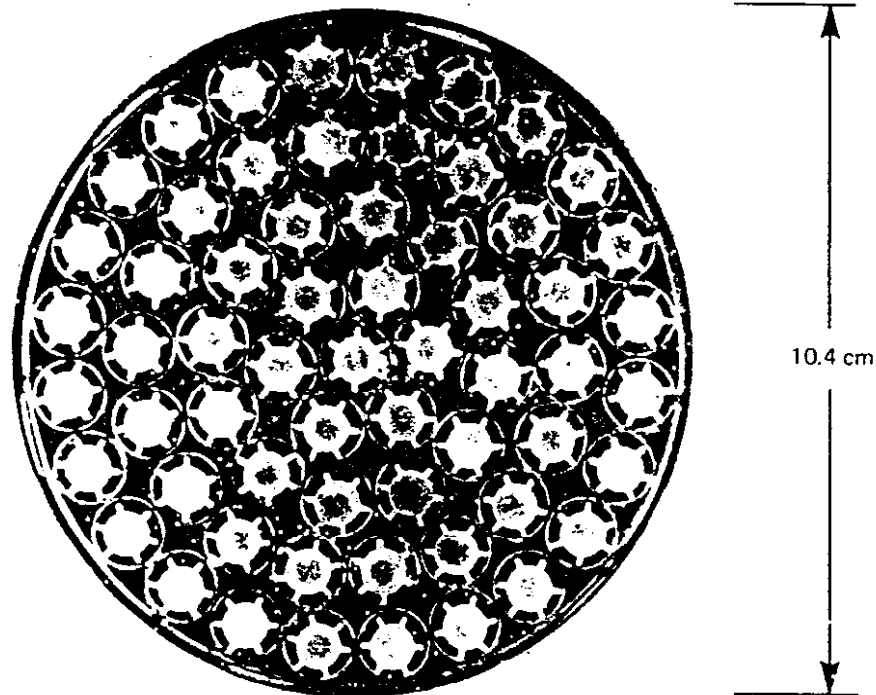

FIGURE 44 *Gentilly Booster Cross Section*

9 FUEL PROCUREMENT

AECL, Fuel Engineering, Power Projects, as a nuclear fuel consultant, is responsible for the design, technical specification and the development program associated with the first core fuel, also the preparation of the tenders and their technical evaluating prior to ordering the first core. See Figure 46.

For the first charges of NPD and Douglas Point, AECL supplied the uranium to the fuel contractor. For later reactors such as Pickering and Bruce, Ontario Hydro bought the uranium in bulk and was responsible for the conversion of U_3O_8 (yellowcake) to UO_2 powder. Eldorado is the only company that can do this in Canada at present. For small orders for Gentilly and NPD, we have contracted with the fuel fabricators to supply both uranium and fuel fabrication.

Ontario Hydro do not ask for fuel warranty, but require a quality assurance and control program. This QC program is continually audited by the utility's inspectors and any concessions must be approved by the design engineer. To date we have discovered very few manufacturing defects in the tens of thousands of bundles we have irradiated. This is of great credit to our fuel contractors and inspectors.

10 FUEL INDUSTRY

The use of short, natural uranium bundles and concentration on a single reactor type has resulted in a very significant fabrication experience of mass producing fuel. Figure 47 shows the total number of fuel bundles ordered, completed, irradiated and discharged as of March 1976. Greater than 122,000 CANDU bundles have already been completed, representing more than 3,250,000 elements and 6,500,000 closure welds. This numerical volume of Zircaloy- UO_2 fuel production experience is the largest in the world.

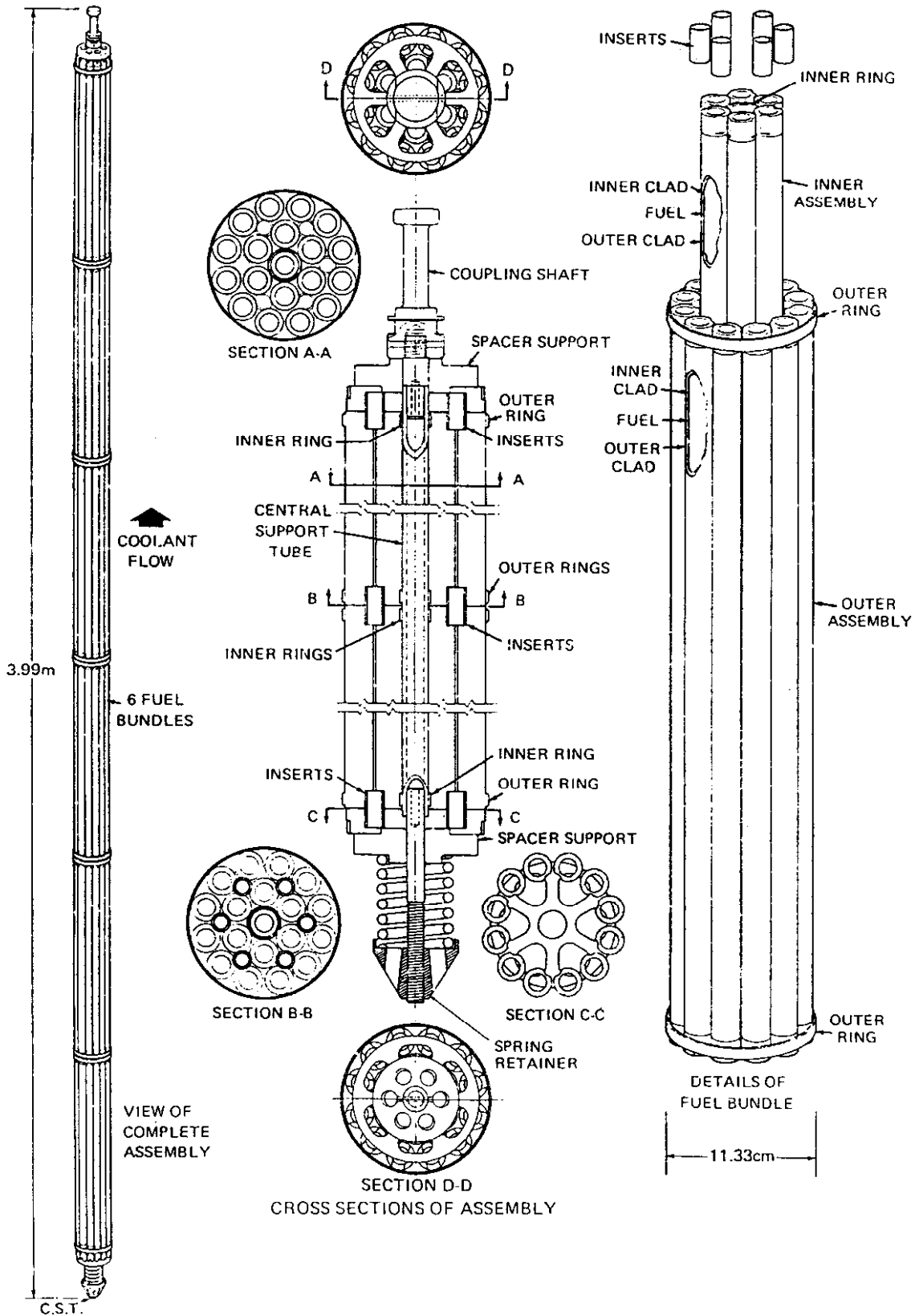

FIGURE 45 Bruce Booster Fuel String Assembly

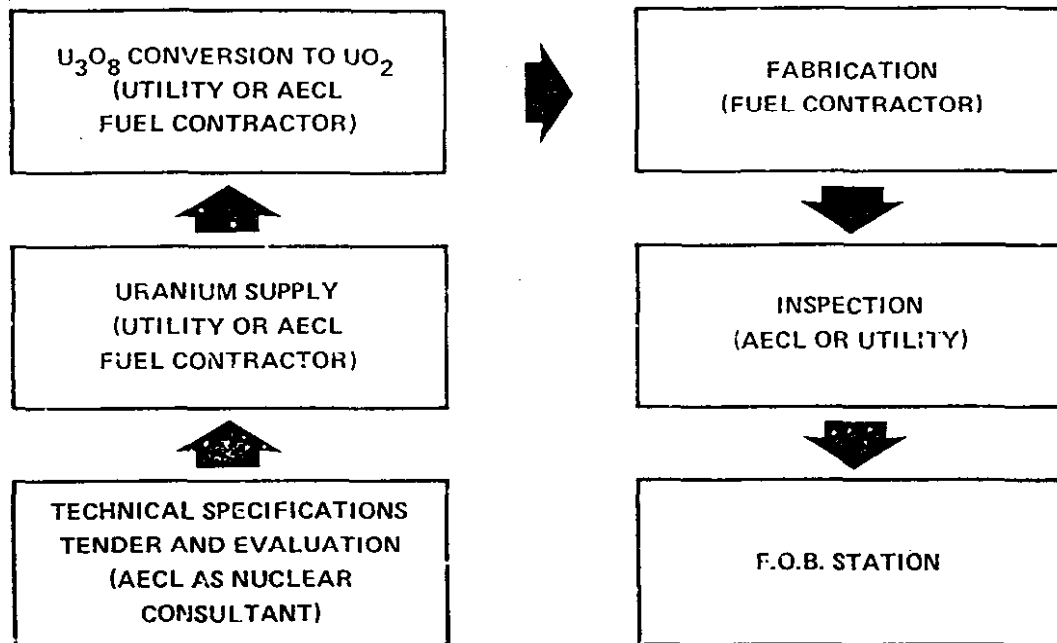

FIGURE 46 Fuel Supply Organization

The maturity of the Canadian fuel industry was celebrated by presenting the 100,000th fuel bundle to the Prime Minister of Canada, at the Canadian Nuclear Association conference in Ottawa, June 1975.

It is well to remember that this amount of nuclear fuel (100,000 bundles) has the capability of producing energy in CANDU reactors equal to that produced by 45 million tons of coal, 205 million barrels of oil or 1,188 billion cubic feet of natural gas.

Ontario Hydro has 8,385 MW(e) operating or under construction and is planning to have 30,000 MW(e) committed in Ontario by 1990. Other utilities (both Canadian and those in other countries using Canadian exports), have 3,181 MW(e) operating or under construction with a further 3,600 MW(e) to be committed in the next decade.

This growth in nuclear power station construction will require a rapid expansion of fuel production as shown in Figure 48, where the Canadian annual uranium requirement is projected to the end of the century (2000). It indicates an expansion from approximately 400 MgU or 25,000 bundles a year capacity in 1975, to over 1,000 MgU by 1980 and with an approximate doubling of capacity every five years during the next decade. The cumulative uranium requirements during the next 25 years will be approximately 8 GgU.

This growth in fuel requirements is also reflected in the amount of Zircaloy ingots that will be required for replacement fuel sheathing. These requirements for reactor fuel sheathing are shown in Figure 49 as well as reactor components such as pressure tube, calandria tubes etc.

11 FUEL COSTS

The procurement policy of all fuel for CANDU reactors has been based on a competitive fixed price bidding system. This has resulted in a decreasing fuel price as the program

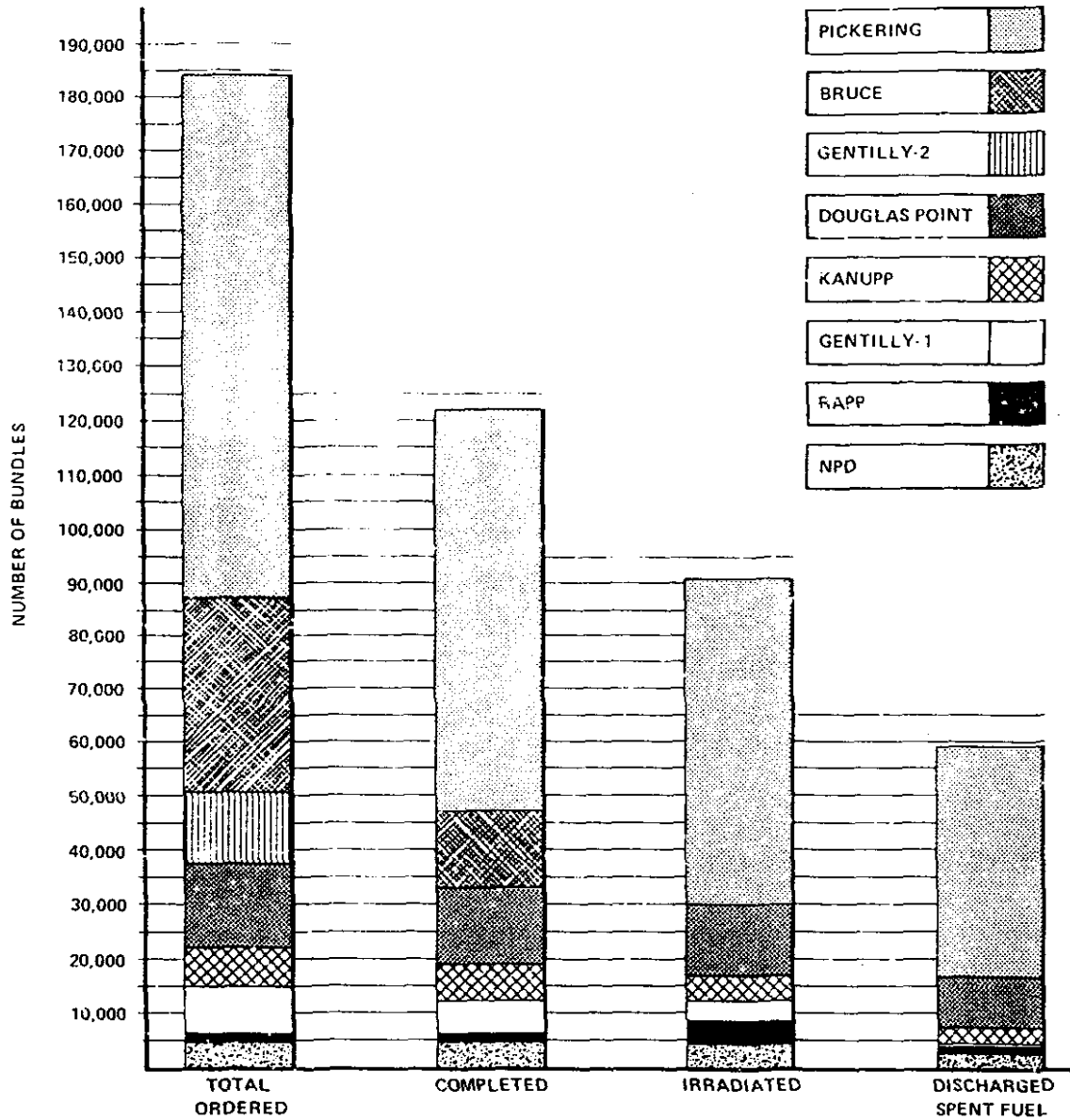

FIGURE 47 CANDU Fuel Production and Irradiation Data (to March 1976)

matured. The total fuel costs in \$ per kgU (including uranium) in dollars of the year, are shown in Figure 50. In the period 1967 to 1973 decreasing fabrication costs countered inflation, achieving constant fuelling costs in this period.

In addition to a "hold the line" price performance, the bundle thermal performance has also improved. Thus, in real terms, the cost relative to thermal performance has decreased substantially.

Spent fuel is given no value or credit for potentially saleable isotopes. The CANDU reactor fuel cycle is a simple once-through cycle with the long-term underwater storage of spent fuel at the reactor sites. Further expansion of this concept of fuel storage is being planned (29, 30).

Today's replacement fuel prices for Pickering G.S. are approximately \$70/kgU (1976 \$Can.).

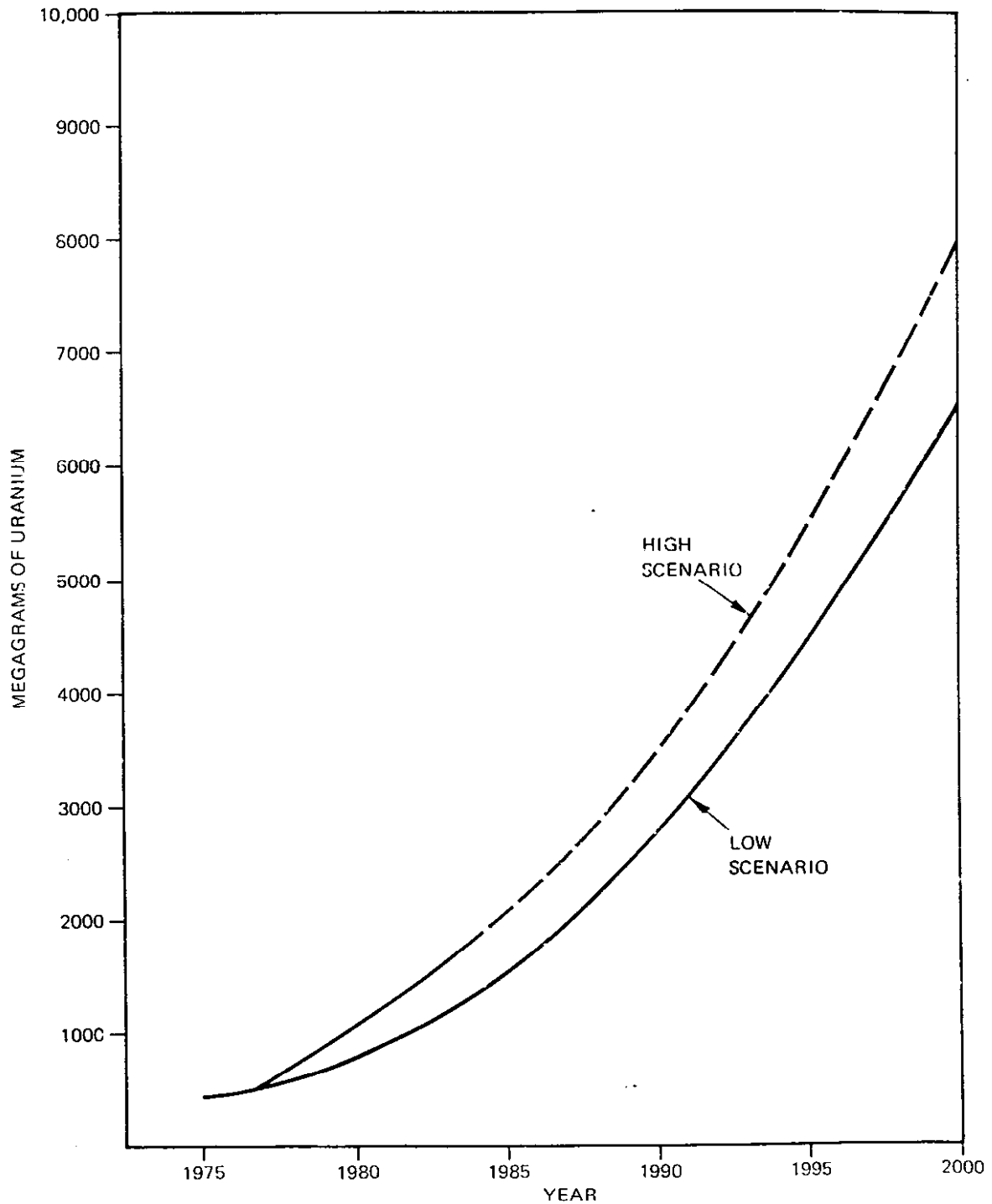

FIGURE 48 Projected Annual CANDU Uranium Consumption

This increase is due to the combined effect of the world price of the uranium and inflation. As the cost of the uranium component is now 75% of the total price, its effect is the stronger. The change in uranium price vs year of contract or delivery is shown in Figure 51.

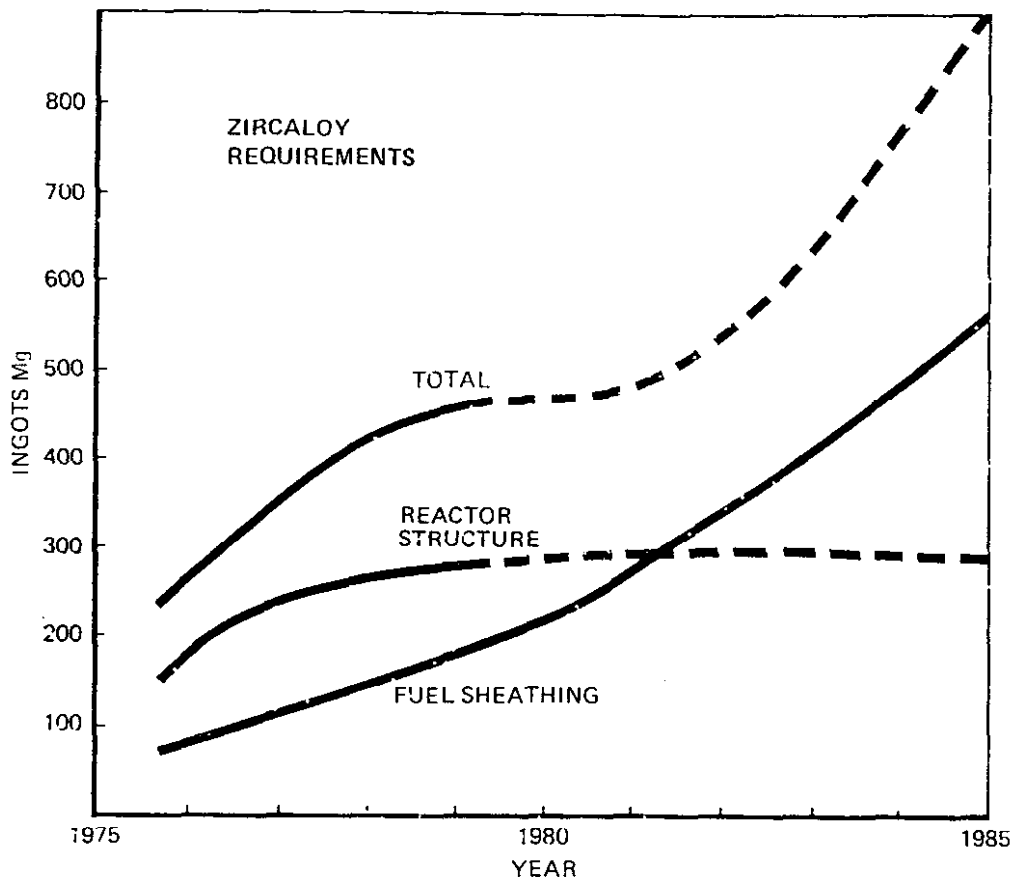
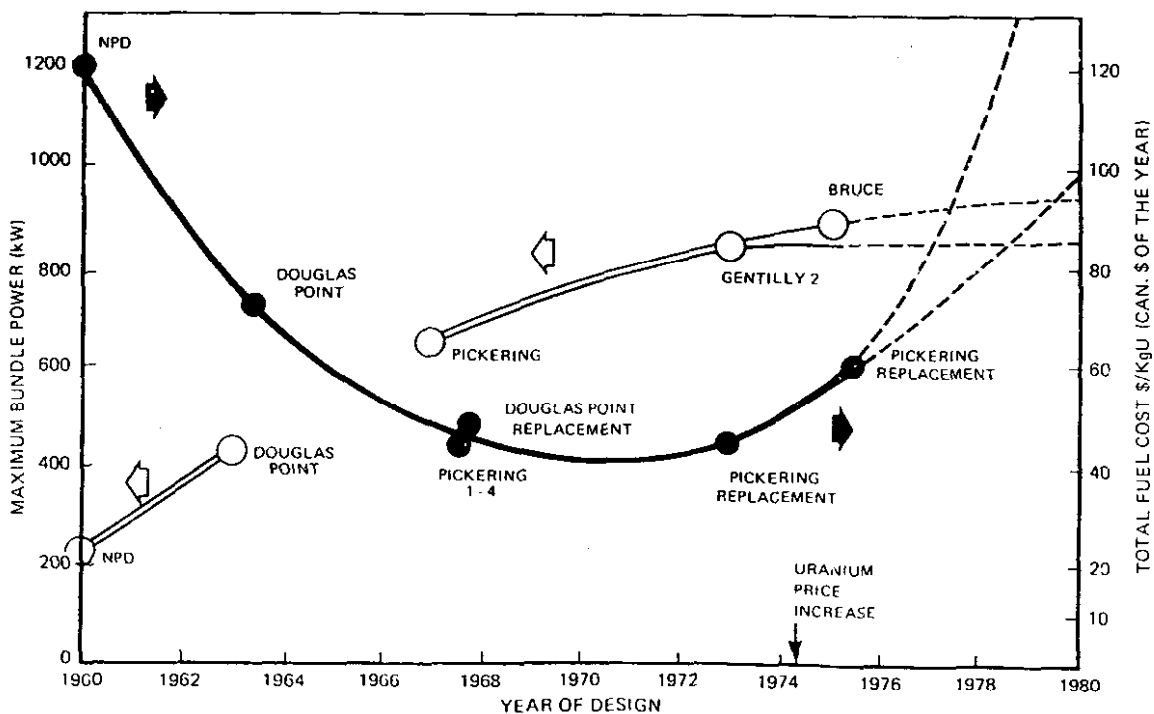

FIGURE 49 CANDU Projected Zircaloy Requirements

FIGURE 50 Variation of Bundle Power and Fuel Costs showing Evolution with Time



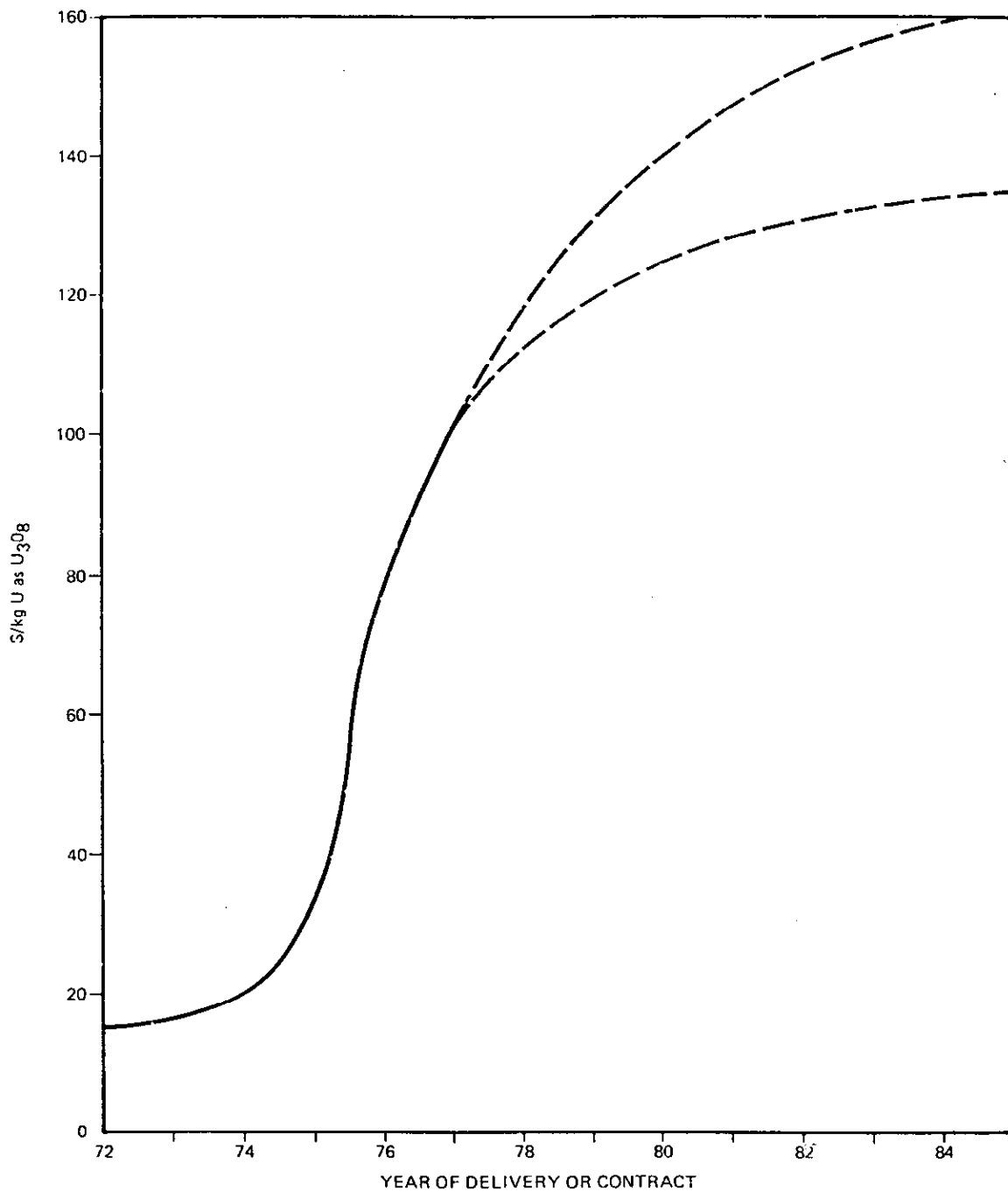

FIGURE 51 Uranium Concentrate Price versus Year of Delivery or Contract

Projection of fuel cost into the future is based on the price change of uranium concentrate and some allowance for inflation. Therefore future fuel costs to utilities will depend on what the world market price is for uranium when they contract for it. The total costs could vary between \$100 and \$200/kgU in the period 1980-1985.

Even with the rising world price of uranium, the CANDU reactor fuelling costs will remain the lowest in the world and lower than its nuclear and fossil competitors by significant margins.

There are still opportunities for evolutionary improvements in CANDU fuel and these are being explored. However, one of the attractive features of the CANDU system is its versatility. The same general design of heavy water moderated pressure tube reactor can exploit many varied fuel cycles with changes in fuel design.

The development of plutonium fuels for future applications in present and planned reactors has started with initial bundles in NPD exceeding burnups of 500 MWh/kgU, compared to the average natural uranium discharge burnup of less than 200 MWh/kgU(31). The overall program, when completed, will allow the utilities to recycle plutonium, when the economic environment warrants its use. The thorium fuel cycle associated with plutonium is also being investigated for application in the late 90's and early years of the twenty-first century to conserve fertile material and counter the rising costs of uranium and other energy sources(32, 33).

The capability of on-power fuelling of the CANDU reactor allows the simple and gradual introduction of new fuel materials such as plutonium and thorium when the economics of future fuel cycles warrants their use. Such versatility makes the CANDU reactor unique among its contemporaries. This provides protection against escalating costs of uranium enrichment and independence from foreign fuel supply, assuring Canadians of adequate resources for centuries, without developing major new reactor concepts.

13 SUMMARY

Early in the development of nuclear power, the pioneers of the Canadian program appreciated the importance of low fuelling costs, hence neutron economy. With CANDU fuel assemblies consisting of only UO₂ and Zircaloy, less than 1% of the incident neutrons are absorbed parasitically in the structural members. The assembly design, essentially unchanged since the first charge for the NPD reactor in 1962, is simply a short (0.5m) bundle of cylindrical elements. This simplicity, combined with the use of natural uranium, has ensured low fabrication costs.

The original selection of materials in the mid-1950s, resulted from a joint AECL/USAEC/UKAEA program of fuel testing, being conducted in NRX at Chalk River because of that reactor's unique potential for such work. Subsequent Canadian work diverged, going for thin-walled, collapsible sheathing requiring the concurrent development of high density UO₂ pellets. As a result, it was possible in 1960 to predict that CANDU fuelling costs would be below 1m\$/kWh. Validation of the CANDU fuel design has always been firmly based on experimental testing, especially in-reactor under realistic conditions. A large program tackled such subjects as the effects of fuel density, stoichiometry and composition, of sheath thickness and mechanical properties, of fuel/sheath clearances and of power generation. The temperature distribution within a fuel element, the migration and release of fission product gases and the behaviour of elements with deliberately punctured sheaths were studied particularly thoroughly. These experimental results were synthesized into a fuel model for design purposes.

Other work refined and confirmed the design during the 1960s. The fuel density was increased slightly, the end closures were made by magnetic-force welding instead of arc-welding, brazed spacers replaced welded wire-wrap, the bundle diameter increased from 82 mm (NPD and Douglas Point) to 104 mm (Pickering et seq). Confidence in the performance was gained successively from irradiation experience with full-size bundles in the NRU reactor loops and

in the NPD and Douglas Point reactors. At each stage thorough post-irradiation examination was an integral part of the program.

53

As in other areas, the operation of the Pickering reactors provided the crucial test of CANDU fuel's commercial viability. In fact, the performance has exceeded expectations with under ¼% of all bundles failed and the fuelling costs have been within the 1m\$/kWh predicted. The extensive irradiation testing program had protected CANDU fuel from the failures due to internal hydriding and fuel densification that affected others. However, early in the operation of Pickering-1, failure rates up to 1% occurred for a short period. Immediate response by AECL and Ontario Hydro was first to identify the cause, then provide solutions. Modified operating procedures, without any derating, reduced the failure rate to negligible proportions, while further development has produced a design modification – Canlub – making the fuel more tolerant of power changes.

With over 122,000 CANDU fuel bundles fabricated and over 91,000 irradiated, confidence in both the costs and performance is well founded.

Though the world price of uranium has increased drastically, CANDU fuelling costs are still the lowest in the world. The CANDU reactors are versatile and can accommodate new fuel cycles such as plutonium and thorium - U₂₃₃ cycles when the economic conditions warrant their use.

ACKNOWLEDGEMENTS

The information contained in this paper has been obtained from many reports written by the AECL staff at CRNL, WNRE, PP and Ontario Hydro Electric Power Commission, therefore there are too many authors to acknowledge individually.

The author would like to acknowledge the helpful comments and assistance of J.A.L. Robertson, L.G. Bell and G. Corbo in the revision of this document.

- (1) A.D. Lane et al: "The Thermal and Hydraulic Characteristics of Power Reactor Fuel Bundle Designs", Canadian Journal of Chemical Engineering, 415 (1963), 226.
- (2) R.D. Page et al: "Engineering and Performance of UO₂ Fuel Assemblies", Proc. Intern. Conf. Peaceful Uses Atomic Energy, Geneva, 10, 65, Atomic Energy of Canada Limited report AECL-2018, 1964.
- (3) M.J.F. Notley and A.D. Lane: "Factors Affecting the Design of Rodded UO₂ Fuel Bundles for High Power Outputs", SM-99/35, IAEA Symposium on Heavy Water Power Reactors, Vienna 1967, Atomic Energy of Canada Limited report AECL-2945.
- (4) R.D. Page: "Engineering and Performance of Canada's UO₂ Fuel Assemblies for Heavy Water Power Reactors", SM-99/48, IAEA Symposium on Heavy Water Power Reactors, September 1967, Atomic Energy of Canada Limited report AECL-2949.
- (5) Z. Domaratzki: "Canadian Experience with Wire Wrapped Fuel for Power Reactors", Atomic Energy of Canada Limited report AECL-3089, May 1968.
- (6) R.D. Page, A.D. Lane: "The Performance of Zirconium Alloy Clad UO₂ Fuel for Canadian Pressurized and Boiling Water Power Reactors", joint ANS/CNA Conference, Toronto, AECL-3068, Atomic Energy of Canada Limited report AECL-3068, June 1968.
- (7) R.G. Hart: "Technological Progress in Canadian Nuclear Fuels", Atomic Energy of Canada Limited report AECL-2928, Nuclear Congress, Rome, 1967.
- (8) L.R. Haywood et al: "Fuel for Canadian Power Reactors", Proc. Intern. Conf., Peaceful Uses of Atomic Energy, Geneva, A/CONF 49/A/156, Atomic Energy of Canada Limited report AECL-3979, 1971.
- (9) J.R. MacEwan et al: "Irradiation Experience with Fuel for Power Reactors", Proc. Intern. Conf., Peaceful Uses of Atomic Energy, Geneva, A/CONF 49/A/158, Atomic Energy of Canada Limited report AECL-3981, 1971.
- (10) "Manufacturing CANDU Fuel", prepared for IAEA Study Group on Facilities and Technology needed for Nuclear Fuel Manufacturing, September 1972.
- (11) J.R. MacEwan, A.J. Jeffs: "Development Program for Plutonium Fuelled CANDU Reactors", presented at IAEA Symposium, unpublished internal Atomic Energy of Canada Limited report, 1974.
- (12) J.A.L. Robertson, $\int \lambda d\theta$ in Fuel Irradiation, Atomic Energy of Canada Limited report AECL-807, January 1969.
- (13) B.A. Cheadle: "The Physical Metallurgy of Zirconium Alloys", unpublished internal Atomic Energy of Canada Limited report, 1975.

- (14) A.S. Bain and J.E. Lesurf: "Oxidation and Hydriding of Zircaloy in NPD Reactor", Atomic Energy of Canada Limited report AECL-3065, January 1968.
- (15) D. Erwin et al: "Some Novel On-Power Refuelling Features of CANDU Stations," Atomic Energy of Canada Limited report AECL-5287, January 1976.
- (16) G.R. Fanjoy et al: "Canadian Nuclear Fuel Operating Experience", ANS/CNA Topical Meeting on Commercial Nuclear Fuel Technology, Toronto, April 1975.
- (17) R.D. Page, G.R. Fanjoy: "Fuel for CANDU Pressurized Heavy Water Reactors", presented at NUCLEX 1975 in Switzerland, Atomic Energy of Canada Limited report AECL-5389.
- (18) J.A.L. Robertson: "Improved Performance for UO₂ Fuel", Atomic Energy of Canada Limited report AECL-4366, January 1973.
- (19) J.C. Wood: Nuclear Technology 26, 63, (1974).
- (20) B. Cox, J.C. Wood: "Corrosion Problems in Energy Conversion and Generation", Pub. The Electrical Chemical Society, ED.C.S. Tedman Jr., October 1974.
- (21) J.A.L. Robertson: "Nuclear Fuel Failures, Their Causes and Remedies", ANS/CNA Topical Meeting on Commercial Nuclear Fuel Technology, Toronto, April 1975.
- (22) E. Rolstand and K.D. Knudsen: Proceedings of 4th International Conference on Peaceful Uses of Atomic Energy", Geneva, 10, 257, IAEA Vienna, 1971.
- (23) S. Aas, K.D. Oshauser: "Fuel Failures Caused by Overpower Ramp", British Nuclear Engineering Society, London, October 1973.
- (24) A.S. Bain, J.C. Wood, C.E. Coleman: "Fuel Designs to Eliminate Defects on Power Increases", British Nuclear Engineering Society, London, October 1973.
- (25) J.A.L. Robertson, R.D. Page, L.L. Bodie: "Canadian Fuel Performance", ANS, Chicago, Illinois, Atomic Energy of Canada Limited report AECL-4520, June 1973.
- (26) J.A.L. Robertson: "The Physical Metallurgy of CANDU Fuel", International Conference on Physical Metallurgy of Reactor Fuel Elements, Berkley Nuclear Laboratories, September 1973.
- (27) W.J. Penn, R.K. Lo, J.C. Wood: "CANDU Fuel - Power Ramp Performance Criteria", ANS, San Francisco, AECL 5572, 1976.
- (28) P. Knudsen: "Cladding Failure in BWR and PWR Overpower Tests". ANS/CNA Topical Meeting on Commercial Nuclear Fuel Technology, Toronto, April 1975.
- (29) R.W. Barns, S.A. Mayman: "The Canadian Program for Management of Spent Fuel and High Level Wastes", ANS/CNA Topical Meeting on Commercial Nuclear Fuel Technology, Toronto, April 1975.

- 56
- (30) P.J. Dyne: "Managing Nuclear Wastes", Atomic Energy of Canada Limited report AECL-5136, May 1976.
 - (31) J.R. MacEwan, A.J. Jeffs: "Development Program for Plutonium Fuelled CANDU Reactors", presented at IAEA Symposium, unpublished internal Atomic Energy of Canada Limited report, November 1974.
 - (32) A.J. Mcoradian, O.J.C. Runnalls: "CANDU - Economic Alternative to Fast Breeders", presented at 9th World Energy Conference, Detroit, Atomic Energy of Canada Limited report AECL-4916, September 1974.
 - (33) S.R. Hatcher et al: "Thorium Cycle in Heavy Water Moderated Pressure Tube (CANDU) Reactors, presented at American Nuclear Society Winter Meeting, San Francisco, November 1975.