

# Pressure Measurement



# Pressure Measurement Devices



# Pressure Scales

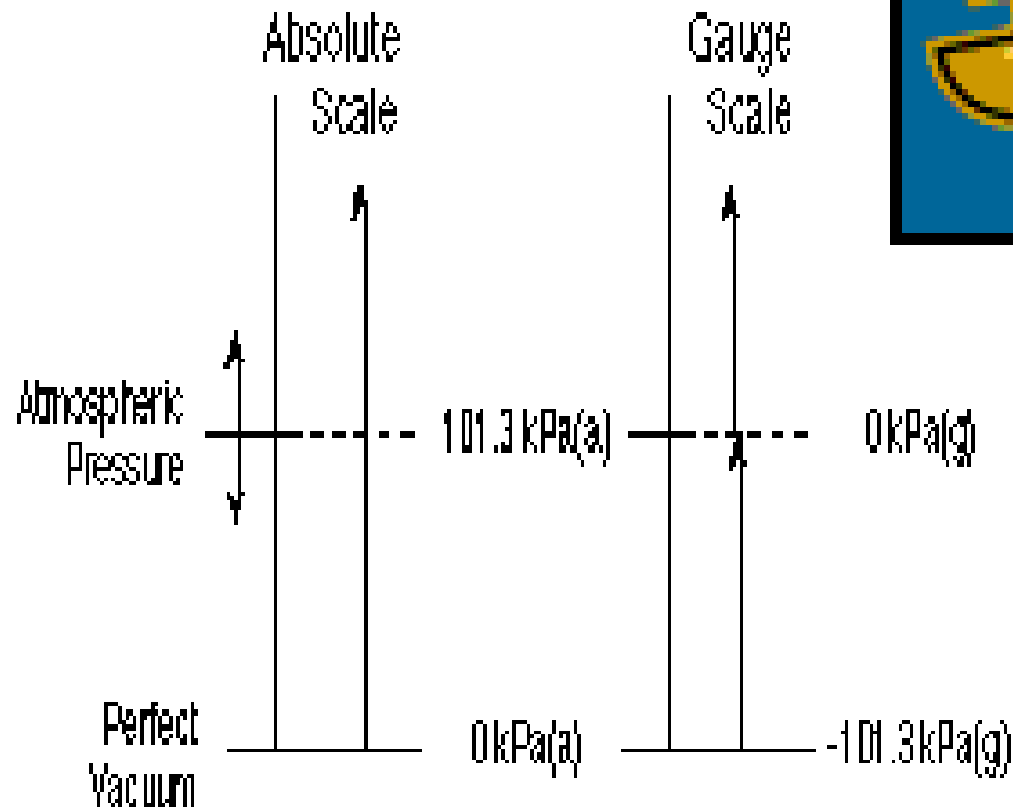

# Bourdon Tube

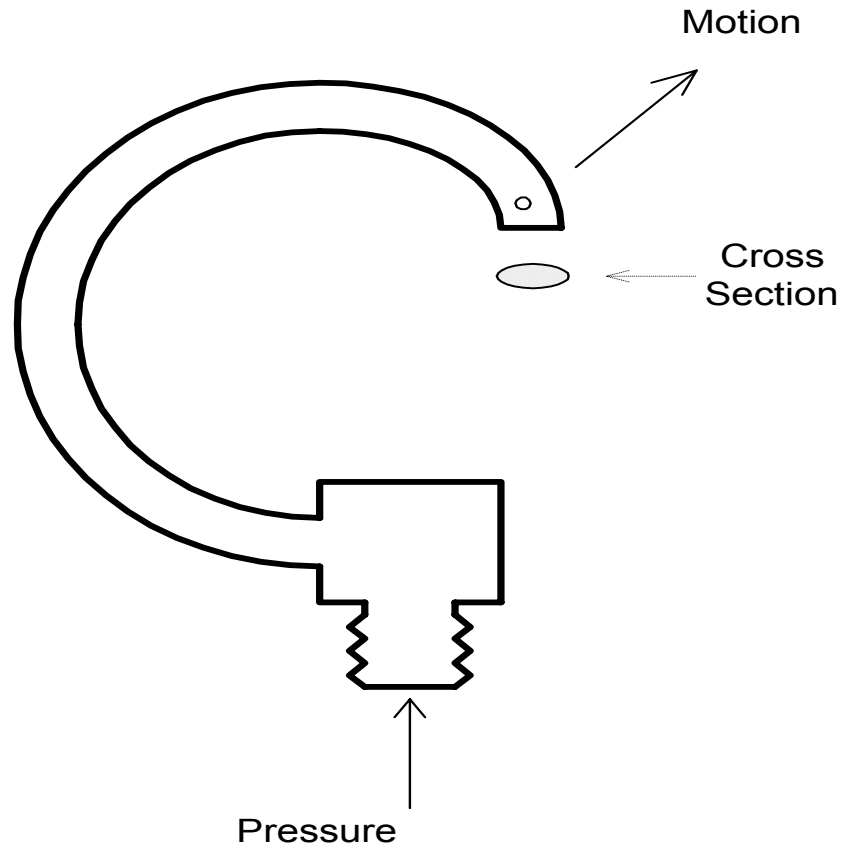

# Bourdon Tube Gauge



# Bourdon Tubes



# Bellows

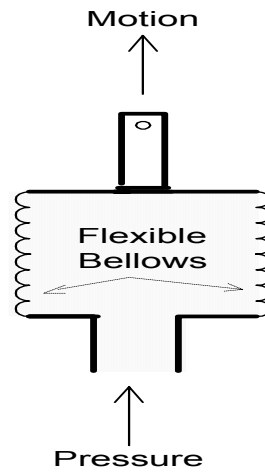

# Bellows Gauges

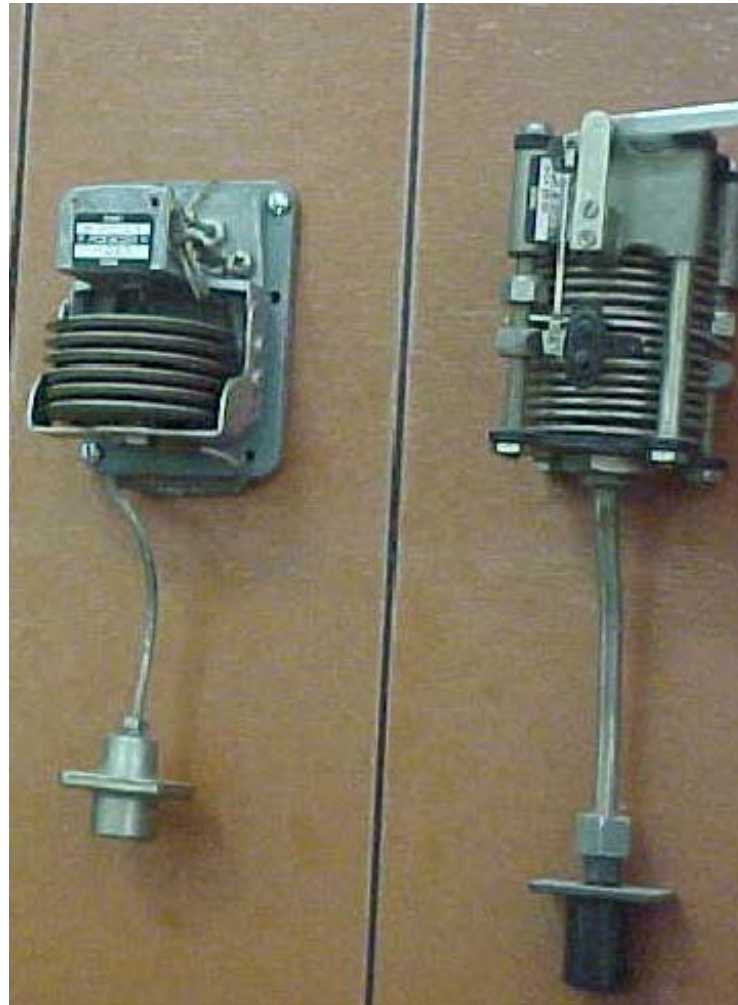



# Diaphragm

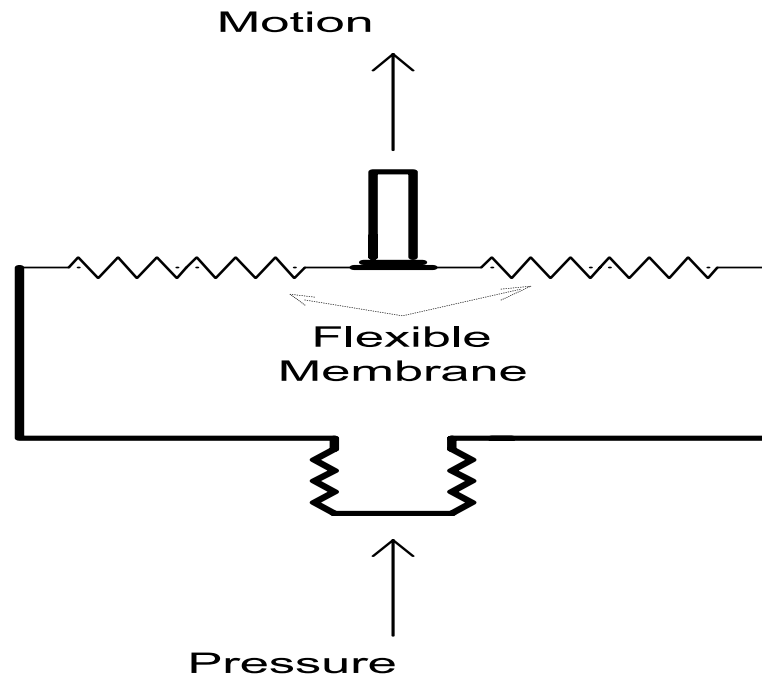

# Diaphragm Differential Gauge



# Switch



# Capsule 1

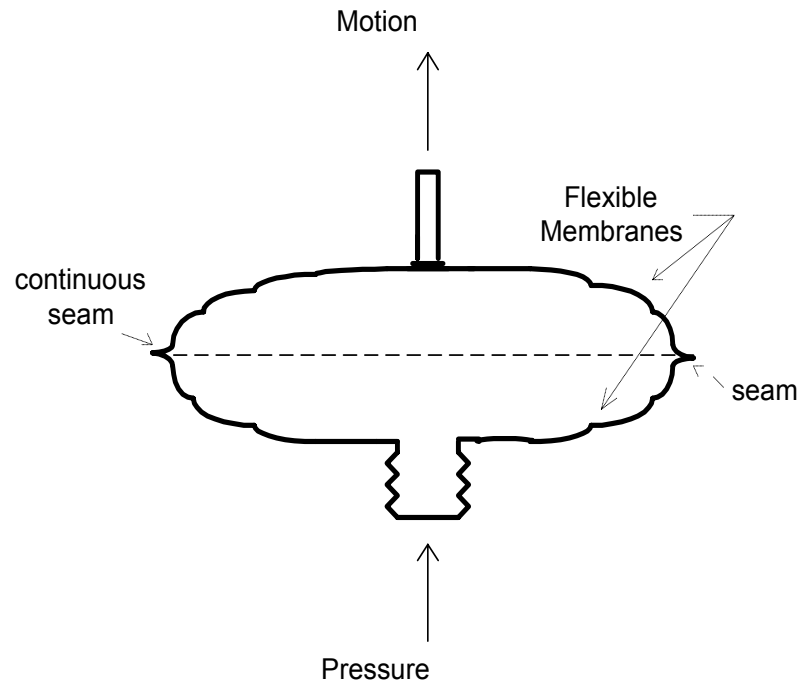

# Capsule 2



# Differential Pressure Cell

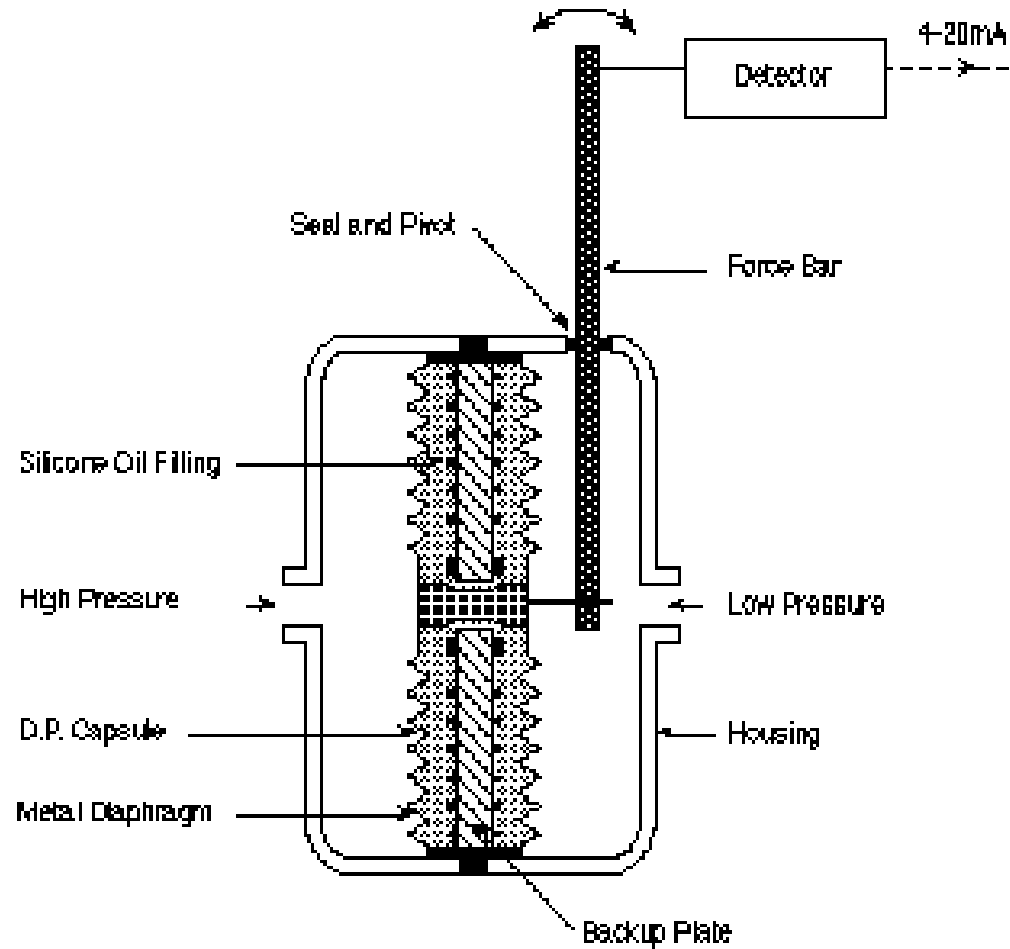

# Typical Pressure Transmitter

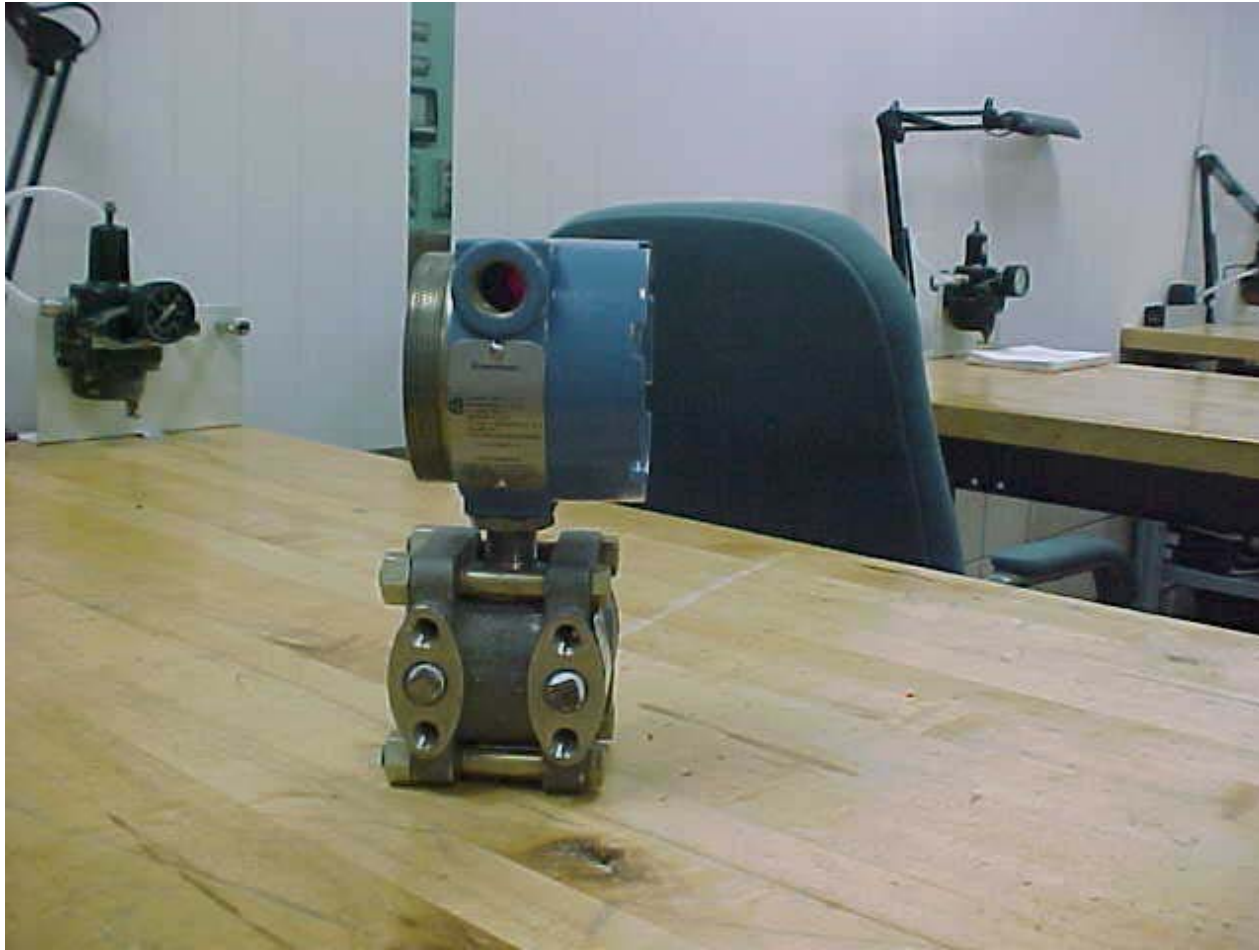

# Pressure Transmitter Installation

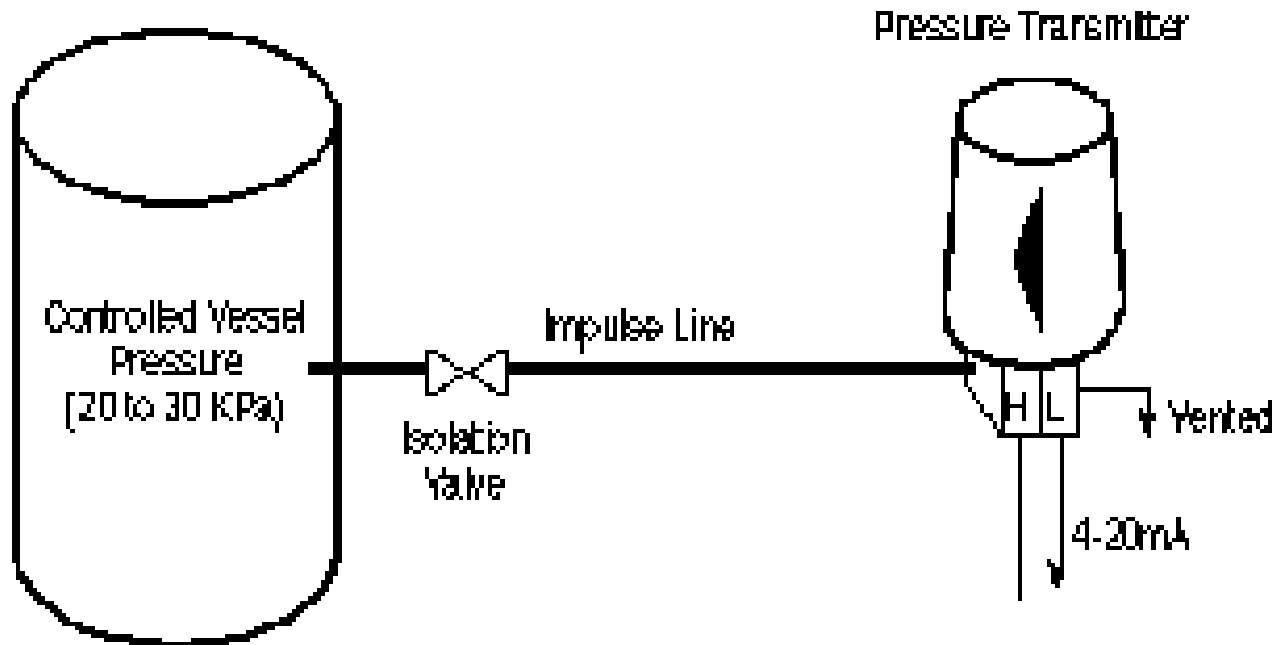



# Strain Gauge

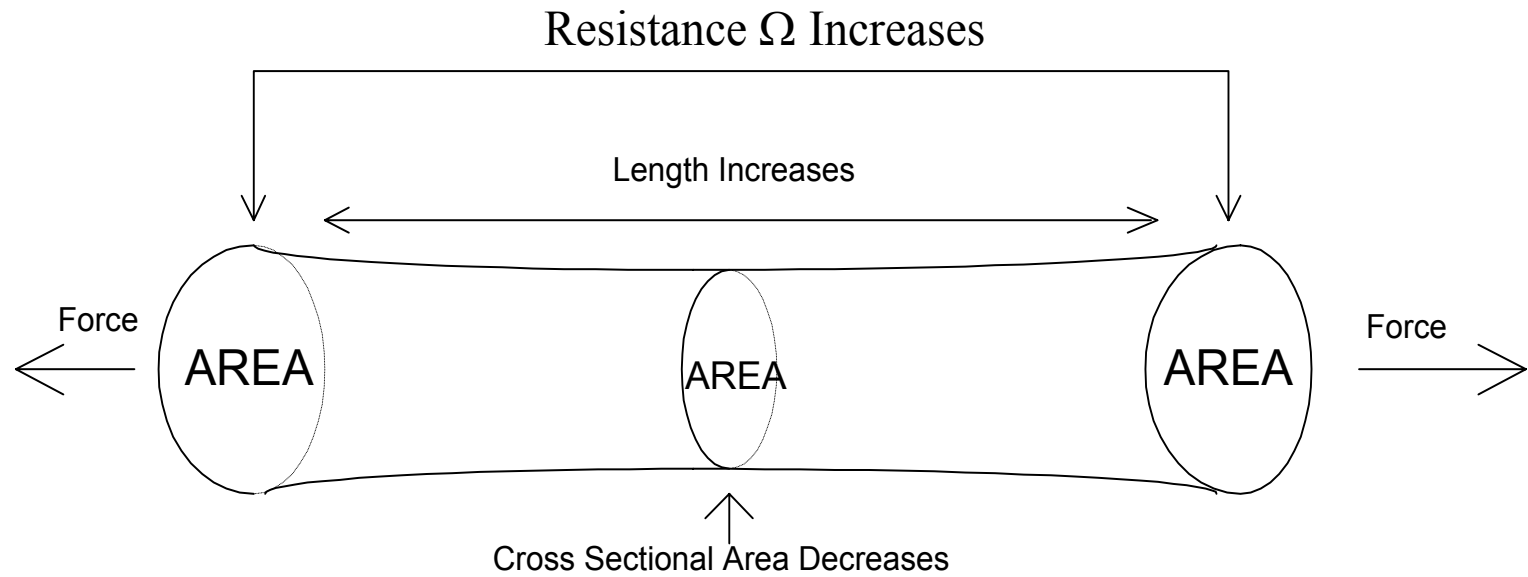

# Strain Gauge DP Cell

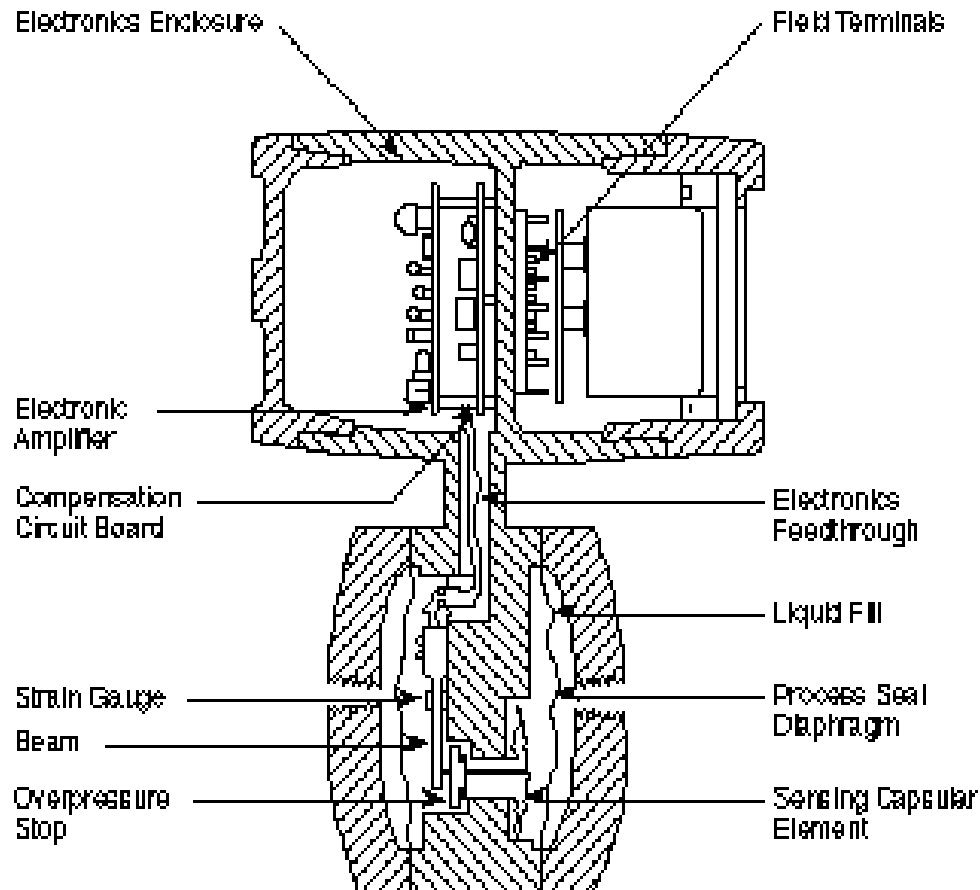

# Capacitance Cells

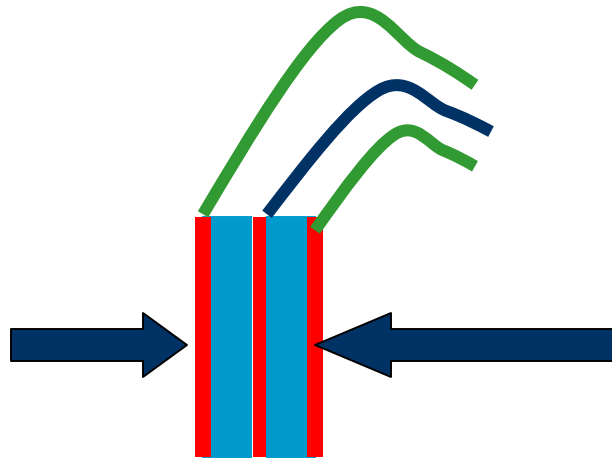



# Operating Environment

- Vibration
- Temperature
- Vapour Content



# Failures and Abnormalities

- Over-pressure
- Blocked sensing lines
- Leaking sensing lines
- Loss of electrical power



# For you to do

- Read pp 8-17
- Answer questions pp. 81-82, #1-5